



crlaurence.co.uk

Ref: DH12UK

# Door Hardware & Partitioning Systems for Glass

Create stylish Door Entrances and Partition Systems from our extensive range of Handles, Patch Fittings, Floorsprings, Locks, Sliding Door Systems, Channels, and Spider Fittings



# Contents

|                                    |    |
|------------------------------------|----|
| Floorsprings                       | 04 |
| Patch Fittings                     | 05 |
| Door Rails and Locks               | 11 |
| Middle Locks                       | 14 |
| Ladder Pulls                       | 16 |
| Door Hinges                        | 20 |
| Sliding Door Systems               | 24 |
| Bi-Fold Door Systems               | 28 |
| Partitioning Systems               | 32 |
| Spider Fittings                    | 38 |
| Fixing Brackets                    | 44 |
| Installation Tools and Accessories | 46 |



For more information call FREE on

**00 800 0421 6144**

e: [CRL@crlaurence.co.uk](mailto:CRL@crlaurence.co.uk) f: 00 800 0262 3299



# **Door Hardware**





## **Floor Springs & Patch Fittings**



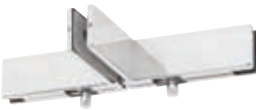

|                                                                                     | CODE                                                      | DESCRIPTION                                                                                                                                                                                                                                                                                                                                                                                                                                                                         |                                                                                     |
|-------------------------------------------------------------------------------------|-----------------------------------------------------------|-------------------------------------------------------------------------------------------------------------------------------------------------------------------------------------------------------------------------------------------------------------------------------------------------------------------------------------------------------------------------------------------------------------------------------------------------------------------------------------|-------------------------------------------------------------------------------------|
|    | <b>CRL8460</b><br>Hold Open                               | <b>CRL Medium Duty 180 Degree Narrow Width Floor Mounted Closer</b> <ul style="list-style-type: none"> <li>• The perfect door closer to support CRL's patch hardware</li> <li>• 120kg capacity, 1067mm doors</li> <li>• Narrow 78mm width</li> <li>• Interchangeable spindle heights</li> <li>• 5 Year limited warranty</li> <li>• UL listed</li> </ul> Warranty information and cross reference chart available                                                                    |  |
|                                                                                     | <b>CRL8462</b><br>No Hold Open                            |                                                                                                                                                                                                                                                                                                                                                                                                                                                                                     |                                                                                     |
|                                                                                     | <b>CRL8460COF</b><br>Coffer Box for Suspended Floors      |                                                                                                                                                                                                                                                                                                                                                                                                                                                                                     |                                                                                     |
|    | <b>CRL8542</b><br>180° No Hold Open                       | <b>CRL Size 4 Spring Heavy Weight Floor Mounted Door Closer</b> <ul style="list-style-type: none"> <li>• The perfect door closer to support CRL's door rail system</li> <li>• 363kg capacity, up to 1372mm doors</li> <li>• Interchangeable spindle heights</li> <li>• Independent closing and latching speed adjustments</li> <li>• 5 Year limited warranty</li> <li>• UL listed</li> </ul> Warranty information and cross reference chart available / Size 3 and 5 also available |                                                                                     |
|                                                                                     | <b>CRL8544</b><br>90° Hold Open                           |                                                                                                                                                                                                                                                                                                                                                                                                                                                                                     |                                                                                     |
|                                                                                     | <b>CRL8546</b><br>105° Hold Open                          |                                                                                                                                                                                                                                                                                                                                                                                                                                                                                     |                                                                                     |
|   | <b>J990NH0D</b><br>No Hold Open                           | <b>CRL Jackson® 900 Series Spring Power Adjustable Floor Mounted Closer with Basic Package</b> <ul style="list-style-type: none"> <li>• 453kg capacity, 1372mm doors</li> <li>• Multi-size spring power adjustable</li> <li>• Interchangeable spindle heights</li> <li>• Leveling and door centring adjustments</li> <li>• 10 Year limited warranty</li> <li>• UL listed</li> </ul>                                                                                                 |                                                                                     |
|                                                                                     | <b>J993H0D</b><br>90° and 120° Dual Hold-Open             |                                                                                                                                                                                                                                                                                                                                                                                                                                                                                     |                                                                                     |
|                                                                                     | <b>J994H0D</b><br>105° Hold Open                          |                                                                                                                                                                                                                                                                                                                                                                                                                                                                                     |                                                                                     |
|                                                                                     | <b>J995BCD</b><br>180° Swing No Hold-Open Backcheck @ 85° |                                                                                                                                                                                                                                                                                                                                                                                                                                                                                     |                                                                                     |
|  | <b>J990NH0N</b><br>No Hold Open                           | <b>CRL Jackson® 900 Series Spring Power Adjustable Floor Mounted Closer with Centre-Hung Package</b> <ul style="list-style-type: none"> <li>• 453kg capacity, 1372mm doors</li> <li>• Multi-size spring power adjustable</li> <li>• Interchangeable spindle heights</li> <li>• Leveling and door centring adjustments</li> <li>• 10 Year limited warranty</li> <li>• UL listed</li> </ul>                                                                                           |                                                                                     |
|                                                                                     | <b>J993H0N</b><br>90° and 120° Dual Hold-Open             |                                                                                                                                                                                                                                                                                                                                                                                                                                                                                     |                                                                                     |
|                                                                                     | <b>J994H0N</b><br>105° Hold Open                          |                                                                                                                                                                                                                                                                                                                                                                                                                                                                                     |                                                                                     |
|                                                                                     | <b>J995BCN</b><br>180° Swing No Hold-Open Backcheck @ 85° |                                                                                                                                                                                                                                                                                                                                                                                                                                                                                     |                                                                                     |
|  | <b>J7020CPBS</b><br>Brushed Stainless                     | <b>CRL Cover Plates for Jackson® 900 Series Floor Mounted Closer</b> <ul style="list-style-type: none"> <li>• Fits 900 series floor mounted door closers</li> <li>• Allows for full closer adjustment without removing door</li> </ul>                                                                                                                                                                                                                                              |                                                                                     |
|                                                                                     | <b>J7020CPPS</b><br>Polished Stainless                    |                                                                                                                                                                                                                                                                                                                                                                                                                                                                                     |                                                                                     |
|  | <b>CRL9040S8</b><br>7.9mm                                 | <b>CRL Interchangeable Floor Closer Spindles</b> <ul style="list-style-type: none"> <li>• Use with all CRL models, Jackson 900, and DORMA® BTS80 series floor mounted door closers</li> <li>• Six available heights from 3.2 To 33.3mm</li> <li>• Flat tapered type</li> </ul>                                                                                                                                                                                                      |                                                                                     |
|                                                                                     | <b>CRL9040S13</b><br>13mm                                 |                                                                                                                                                                                                                                                                                                                                                                                                                                                                                     |                                                                                     |
|                                                                                     | <b>CRL9040S18</b><br>19mm                                 |                                                                                                                                                                                                                                                                                                                                                                                                                                                                                     |                                                                                     |
|                                                                                     | <b>CRL9040S23</b><br>22mm                                 |                                                                                                                                                                                                                                                                                                                                                                                                                                                                                     |                                                                                     |



|                                                                                     | CODE                                  | DESCRIPTION                                                                                                                                                                                                                                                                                               |
|-------------------------------------------------------------------------------------|---------------------------------------|-----------------------------------------------------------------------------------------------------------------------------------------------------------------------------------------------------------------------------------------------------------------------------------------------------------|
|    | <b>PH21ABS</b><br>Brushed Stainless   | <b>CRL Top Door Patch Fitting with 1NT303 Insert</b> <ul style="list-style-type: none"> <li>• European 65mm pivot setback</li> <li>• High density cast body</li> <li>• Gaskets for use with 10 or 12mm glass</li> <li>• For use with Free Swing Top Pivot</li> </ul>                                      |
|                                                                                     | <b>PH21APS</b><br>Polished Stainless  |                                                                                                                                                                                                                                                                                                           |
|    | <b>PH21CBS</b><br>Brushed Stainless   | <b>CRL Adjustable European Top Door Patch Fitting</b> <ul style="list-style-type: none"> <li>• Adjustable pivot insert allows three degrees movement for proper door alignment</li> <li>• 65mm pivot setback</li> <li>• For 10 or 12mm glass</li> <li>• For use with Concealed Overhead Closer</li> </ul> |
|                                                                                     | <b>PH21CPS</b><br>Polished Stainless  |                                                                                                                                                                                                                                                                                                           |
|     | <b>PH11CBS</b><br>Brushed Stainless   | <b>CRL Bottom Door Patch with 1NT301 Insert</b> <ul style="list-style-type: none"> <li>• 65mm pivot setback</li> <li>• For 10 or 12mm glass</li> <li>• For use with Floor Spring/Free Swing Bottom Pivot</li> </ul>                                                                                       |
|                                                                                     | <b>PH11CPS</b><br>Polished Stainless  |                                                                                                                                                                                                                                                                                                           |
|   | <b>PH40BS</b><br>Brushed Stainless    | <b>CRL Sidelite Transom Patch with 1NT300 Insert</b> <ul style="list-style-type: none"> <li>• Works with both 70mm and 65mm pivot setback door patch fittings</li> <li>• For 10 or 12mm glass</li> </ul>                                                                                                  |
|                                                                                     | <b>PH40PS</b><br>Polished Stainless   |                                                                                                                                                                                                                                                                                                           |
|  | <b>PH34BS</b><br>Brushed Stainless    | <b>CRL Wall Mounted Transom Patch with 1NT300 Insert</b> <ul style="list-style-type: none"> <li>• For 10 or 12mm glass</li> </ul>                                                                                                                                                                         |
|                                                                                     | <b>PH34PS</b><br>Polished Stainless   |                                                                                                                                                                                                                                                                                                           |
|  | <b>PH41LBS</b><br>Left Hand Brushed   | <b>CRL Sidelite Transom Patch with Support Fin Bracket and 1NT300 Insert</b> <ul style="list-style-type: none"> <li>• Works with both 70mm and 65mm pivot setback door patch fittings</li> <li>• For 10 or 12mm glass</li> <li>• Left and right handed</li> </ul>                                         |
|                                                                                     | <b>PH41LPS</b><br>Left Hand Polished  |                                                                                                                                                                                                                                                                                                           |
|                                                                                     | <b>PH41RBS</b><br>Right Hand Brushed  |                                                                                                                                                                                                                                                                                                           |
|                                                                                     | <b>PH41RPS</b><br>Right Hand Polished |                                                                                                                                                                                                                                                                                                           |

# CRL Patch Fittings

|                                                                                     | CODE                                  | DESCRIPTION                                                                                                                                                                                                                                   |
|-------------------------------------------------------------------------------------|---------------------------------------|-----------------------------------------------------------------------------------------------------------------------------------------------------------------------------------------------------------------------------------------------|
|    | <b>PH42LBS</b><br>Left Hand Brushed   | <b>CRL 90 Degree Sidelite Patch with 1NT300 Insert</b> <ul style="list-style-type: none"> <li>• Works with 65mm pivot setback door patch fittings</li> <li>• For 10 and 12mm glass</li> <li>• Left and right handed</li> </ul>                |
|                                                                                     | <b>PH42RBS</b><br>Right Hand Brushed  |                                                                                                                                                                                                                                               |
|                                                                                     | <b>PH42LPS</b><br>Left Hand Polished  |                                                                                                                                                                                                                                               |
|                                                                                     | <b>PH42RPS</b><br>Right Hand Polished |                                                                                                                                                                                                                                               |
|    | <b>PH51BS</b><br>Brushed Stainless    | <b>CRL Double Transom Patch with Fin and Two 1NT300</b> <ul style="list-style-type: none"> <li>• Works with both 70mm and 65mm pivot setback door patch fittings</li> <li>• High density cast body</li> <li>• For 10 or 12mm glass</li> </ul> |
|                                                                                     | <b>PH51PS</b><br>Polished Stainless   |                                                                                                                                                                                                                                               |
|   | <b>PH94BS</b><br>Brushed Stainless    | <b>CRL Ceiling Mounted Support Fin Bracket Patch Fitting</b> <ul style="list-style-type: none"> <li>• For 10 or 12mm glass</li> </ul>                                                                                                         |
|                                                                                     | <b>PH94PS</b><br>Polished Stainless   |                                                                                                                                                                                                                                               |
|   | <b>PH71BS</b><br>Brushed Stainless    | <b>CRL Transom Mounted Patch Connector with Support Fin Bracket</b> <ul style="list-style-type: none"> <li>• For 10 or 12mm glass</li> </ul>                                                                                                  |
|                                                                                     | <b>PH71PS</b><br>Polished Stainless   |                                                                                                                                                                                                                                               |
|  | <b>PH80BS</b><br>Brushed Stainless    | <b>CRL Brushed Stainless 4-Way Patch Connector</b> <ul style="list-style-type: none"> <li>• For 10 or 12mm glass</li> </ul>                                                                                                                   |
|                                                                                     | <b>PH80PS</b><br>Polished Stainless   |                                                                                                                                                                                                                                               |
|  | <b>PH81BS</b><br>Brushed Stainless    | <b>CRL 4-Way Patch Connector with Support Fin Bracket</b> <ul style="list-style-type: none"> <li>• For 10 or 12mm glass</li> </ul>                                                                                                            |
|                                                                                     | <b>PH81PS</b><br>Polished Stainless   |                                                                                                                                                                                                                                               |

|                                                                                     | CODE                                                                                       | DESCRIPTION                                                                                                                                                                                                                                                                                                                 |
|-------------------------------------------------------------------------------------|--------------------------------------------------------------------------------------------|-----------------------------------------------------------------------------------------------------------------------------------------------------------------------------------------------------------------------------------------------------------------------------------------------------------------------------|
|    | <p><b>PH60BS</b><br/>Brushed Stainless</p> <p><b>PH60PS</b><br/>Polished Stainless</p>     | <p><b>CRL Sidelite Mounted Transom Patch with Reversible Door Stop with 1NT310 Insert</b></p> <ul style="list-style-type: none"> <li>• For 10 or 12mm glass</li> <li>• Doors can swing either in or out</li> <li>• 1 x 1NT310 CRL Door Stop Insert included</li> </ul>                                                      |
|    | <p><b>PH70BS</b><br/>Brushed Stainless</p> <p><b>PH70PS</b><br/>Polished Stainless</p>     | <p><b>CRL Transom Mounted Connector with Two Reversible Door Stops with 1NT310 Inserts</b></p> <ul style="list-style-type: none"> <li>• For 10 or 12mm glass</li> <li>• Doors can swing either in or out</li> <li>• One door can swing in and the other out</li> <li>• 2 x 1NT310 CRL Door Stop Inserts included</li> </ul> |
|   | <p><b>EUR205BS</b><br/>Brushed Stainless</p> <p><b>EUR205PS</b><br/>Polished Stainless</p> | <p><b>CRL EUR Series Complete Patch Lock Including Cylinder</b></p> <ul style="list-style-type: none"> <li>• High density cast body with lock mechanism</li> <li>• Gaskets for use with 10 or 12mm glass</li> <li>• For 10 or 12mm glass</li> </ul>                                                                         |
|  | <p><b>EUR206BS</b><br/>Brushed Stainless</p> <p><b>EUR206PS</b><br/>Polished Stainless</p> | <p><b>CRL Brushed Stainless EUR Series Sidelite or Glass Door Mounted Keeper</b></p> <ul style="list-style-type: none"> <li>• For use with EUR205 series patch lock</li> <li>• High density cast body with lock mechanism</li> <li>• For 10 or 12mm glass</li> </ul>                                                        |
|  | <p><b>1NT401</b></p>                                                                       | <p><b>CRL Free Swing Top Pivot</b></p> <ul style="list-style-type: none"> <li>• Surface mount top pivot type for use with patch fittings and CRL Wedge-Lock™ door rail system</li> <li>• Brushed stainless finish</li> </ul>                                                                                                |





# CRL Patch Fittings

| CODE                                                                                                                                                                  | DESCRIPTION                                                                                                                                                                                                                                                                                                                          |
|-----------------------------------------------------------------------------------------------------------------------------------------------------------------------|--------------------------------------------------------------------------------------------------------------------------------------------------------------------------------------------------------------------------------------------------------------------------------------------------------------------------------------|
|  <p>1NT402</p>                                                                        | <p><b>CRL Floor Mounted Bottom Free-Swinging Pivot</b></p> <ul style="list-style-type: none"> <li>• 22mm flat tapered spindle</li> <li>• 200kg capacity</li> </ul>                                                                                                                                                                   |
|  <p>1NT403</p>                                                                        | <p><b>CRL Adjustable Free-Swinging Floor Pivot</b></p> <ul style="list-style-type: none"> <li>• For use with our low profile door rails, PH10C, PH11C, and EUR410 bottom door patch fittings</li> <li>• 100kg capacity</li> <li>• 9.5mm minimum clearance</li> <li>• 5mm height adjustment</li> <li>• Aluminium in colour</li> </ul> |
|  <p>1NT405</p>                                                                      | <p><b>CRL Brushed Stainless Finish Header Mounted Top Free Swinging Pivot</b></p> <ul style="list-style-type: none"> <li>• For use with top door patch fittings</li> <li>• Mounts in masonry or metal header</li> </ul>                                                                                                              |
|  <p>1NT406</p>                                                                     | <p><b>CRL Adjustable Free-Swinging Floor Pivot with Tapered Flat Spindle</b></p> <ul style="list-style-type: none"> <li>• Flat tapered spindle</li> <li>• 100kg capacity</li> <li>• Provides 6mm height adjustment</li> </ul>                                                                                                        |
|  <p>CRL9040WBP</p>                                                                  | <p><b>CRL Walking Beam Top Pivot</b></p> <ul style="list-style-type: none"> <li>• For centre-hung applications when using a concealed floor mounted door closer</li> <li>• Optional cover plates available in several finishes</li> </ul>                                                                                            |
|  <p>CRL9040CPBS<br/>Brushed Stainless</p> <p>CRL9040CPPS<br/>Polished Stainless</p> | <p><b>CRL Brushed Stainless Walking Beam Top Pivot Cover Plat</b></p> <ul style="list-style-type: none"> <li>• Used to cover and conceal the crl walking beam top pivot</li> <li>• Five finishes available</li> <li>• For centre-hung applications when using a concealed floor mounted door closer</li> </ul>                       |

| CODE                                                                                   | DESCRIPTION                                                                                                                                                                                                                                                                                                                                            |
|----------------------------------------------------------------------------------------|--------------------------------------------------------------------------------------------------------------------------------------------------------------------------------------------------------------------------------------------------------------------------------------------------------------------------------------------------------|
| 1NT304                                                                                 | <p><b>CRL Top Door Closer Patch Insert for Use with Door Closers with 14mm Square Spindle</b></p> <ul style="list-style-type: none"> <li>• For use with PH20 and PH21 top door patch fittings</li> <li>• Suitable for use with standard 14mm square spindle overhead concealed door closers</li> </ul>                                                 |
|       |                                                                                                                                                                                                                                                                                                                                                        |
| 1NT306                                                                                 | <p><b>CRL Transom Patch Door Stop Insert</b></p> <ul style="list-style-type: none"> <li>• For use with Cat. Nos. PH34, PH40, PH41L, PH41R, PH42L, PH42R, PH43L, PH43R and PH51 transom patch fittings to create a door stop</li> </ul>                                                                                                                 |
|       |                                                                                                                                                                                                                                                                                                                                                        |
| 1NT310                                                                                 | <p><b>CRL Door Stop Insert for PH60/70</b></p> <ul style="list-style-type: none"> <li>• For use with: PH60 and PH70</li> </ul>                                                                                                                                                                                                                         |
|      |                                                                                                                                                                                                                                                                                                                                                        |
| EUR208PS                                                                               | <p><b>CRL Polished Stainless Finish “Easy Clean” European Style Bottom Keeper with Mounting Plate</b></p> <ul style="list-style-type: none"> <li>• For use with our EUR205 patch lock</li> </ul>                                                                                                                                                       |
|     |                                                                                                                                                                                                                                                                                                                                                        |
| <p><b>J580BS</b><br/>Brushed Stainless</p> <p><b>J580PS</b><br/>Polished Stainless</p> | <p><b>CRL Jackson® Heavy-Duty Adjustable Centre-Hung Walking Beam Type Top Pivot with Brushed Stainless Cover Plate</b></p> <ul style="list-style-type: none"> <li>• Walking beam type pivot</li> <li>• For centre-hung doors weighing up to 454kg</li> <li>• Allows for easy door removal and adjustment</li> <li>• Lateral pin adjustment</li> </ul> |
|     |                                                                                                                                                                                                                                                                                                                                                        |

# CRL Door Rails and Locks

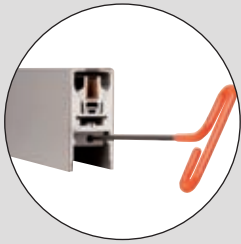

**Kwik-Adjust™ Pivot Alignment System**



- Available in six different finishes
- Matching sidelites available
- Available with or without Locks (Eurocylinders Locks)
- Designed to work effectively with full CRL range of products - Patch fittings, Handles, Locks & Floorsprings
- A range of standard length Door Rails available, including Low Profile, Tapered and Square Rails

We are proud to introduce our patented Wedge-Lock™ Glass Securing System, now with the Kwik-Adjust™ Pivot Alignment System that allows the installer to quickly and easily adjust the lateral alignment of the pivot centres by simply turning a single screw in either the top or bottom rail of the door. All of our 102mm, 152mm and 254mm tall Door Rails, as well as our Patch Rails, utilize both Wedge-Lock™ and Kwik-Adjust™ technologies, giving you the most versatile rail system on the market today.

## KEY DETAILS

- Manufactured door rails cut to length from stock in Manchester (102mm Square only)
- Cut to length - between 750mm and 1250mm, for rails 102mm in height
- Door Rails for 15mm and 19mm glass available by special request
- Fully adjustable - adjust and align doors
- Features the Kwik-Adjust™ vertical Jamb Alignment System, adjustable door left to right +/- 3mm
- Door assembly can be ready for installation in less than 10 minutes
- Doors fully adjustable along the line of the closed position

## Complete Adjustment **A B C**

### **A** How the Wedge-Lock™ Glass Securing System Works

The Wedge-Lock™ System works by applying pressure evenly along both sides of the glass. Simply tighten the jaw screws, accessed from the hardware pocket of the rail. The screws then draw down a flat stainless steel bar. The steel bar in turn pulls down the gripping jaws. This action then forces the jaws towards one another, creating a tremendous amount of force against the glass, holding it securely in place.

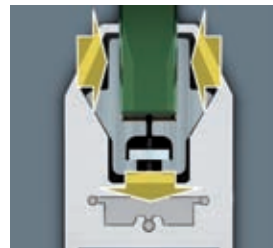

**Exclusive Wedge-Lock™ Glass Securing System**



**Kwik-Adjust™ Pivot Alignment System**

### **B** Jamb Adjustment

#### To Adjust the Door Rail Away From the Jamb

1. Remove the end cap (one screw). This will reveal the adjustment screw.
2. Insert the T912 T-Handle Key into the screw and turn the screw clockwise to the proper clearance from the jamb.
3. Replace the End Cap.

#### To Adjust the Door Rail Towards the Jamb

1. Remove the end cap (one screw).
2. Insert the T912 T-handle key into the screw and turn the screw counter-clockwise to the proper clearance from the jamb.
3. Replace the end cap.

### **C** Centring Adjustment

To centre the door you just loosen the two Pan Head Phillips Screws, holding the arm to the block, then adjust the two hex bolts at the end of each arm to slightly change the angle of the arm as it mounts in the Door Rail. Make sure that both hex bolts are tightened against the inside face of the Door Rail, and the two Pan Head Phillips Screws are tightened to the block when adjustment is complete.

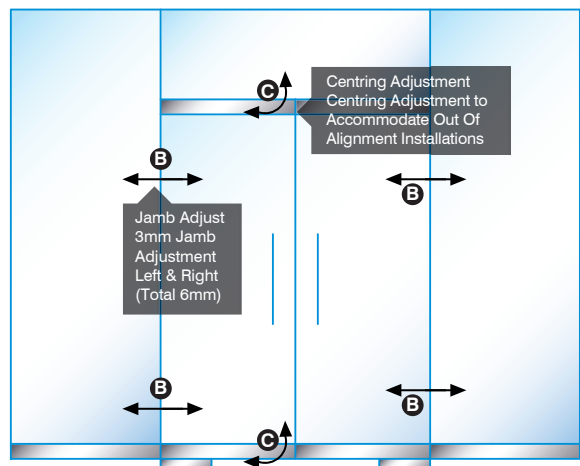

Door centring is easily achieved by turning the two hex head bolts.

# CRL Door Rails and Locks

## CODE

## DESCRIPTION



### EDR4SBS38

Brushed Stainless (10mm Glass)

### EDR4SBS12

Brushed Stainless (12mm Glass)

### EDR4SPS38

Polished Stainless (10mm Glass)

### EDR4SPS12

Polished Stainless (12mm Glass)

### CRL Wedgelock Door Rails

- Patented Wedge-Lock™ glass securing system
- For 10mm or 12mm glass (15mm and 19mm on request)
- Door rails up to 1250mm wide
- Adjust and align doors without removal
- Nine standard architectural finishes
- Custom sizes are also available



### EDR4SBS38L

Brushed Stainless (10mm Glass)

### EDR4SBS12L

Brushed Stainless (12mm Glass)

### EDR4SPS38L

Polished Stainless (10mm Glass)

### EDR4SPS12L

Polished Stainless (12mm Glass)

### CRL Wedgelock Door Rails with Locks

- Patented Wedge-Lock™ glass securing system
- For 10mm or 12mm glass (15mm and 19mm on request)
- Door rails up to 1250mm wide
- Adjust and align doors without removal
- Nine standard architectural finishes
- Custom sizes are also available
- Available with locks



### AMR207BN

Brushed Nickel

### AMR207PS

Polished Stainless

### Dust Proof Keeper

- Accepts a 16mm Plunger
  - Three Finishes Available
- CRL dustproof keepers are intended for use with our door rail locks. They are easy-to-install and only require a 25.4mm diameter by 51mm deep hole in the floor.



### AMR209BN

Brushed Nickel

### AMR209PS

Polished Stainless

### CRL Locking Dustproof Keeper

- Accepts 16mm diameter plunger bolt
  - Three Finishes Available
- CRL dustproof keepers are intended for use with our door rail locks. They are easy-to-install and only require a 25.4mm diameter by 51mm deep hole in the floor.



### EC3BS

Brushed Stainless

### EC3PS

Polished Stainless

### EC3BSKA

Brushed Stainless

### EC3PSKA

Polished Stainless

### CRL Brushed Stainless Cylinder Lock with Thumbturn

- Works on PTH311 series lever latch installation and euro style patch locks EUR205, EUR680, and EUR681
- Available in three finishes
- Available individual key or keyed alike



### EC5BS

Brushed Stainless

### EC5PS

Polished Stainless

### EC5BSKA

Brushed Stainless  
Keyed alike



### EC5PSKA

Polished Stainless  
Keyed alike

### CRL Brushed Stainless Extended Length Keyed Cylinder/Cylinder



- Works on PTH311 series lever latch installation and euro style patch locks EUR205, EUR680, and EUR681
- Available in three finishes
- Available individual key or keyed alike







| CODE                                                                                | DESCRIPTION                                                                                                                                                                                                                                                                                                                                                                                                                                                                                                                                                                 |
|-------------------------------------------------------------------------------------|-----------------------------------------------------------------------------------------------------------------------------------------------------------------------------------------------------------------------------------------------------------------------------------------------------------------------------------------------------------------------------------------------------------------------------------------------------------------------------------------------------------------------------------------------------------------------------|
|    | <p><b>DRWSAS</b><br/>Satin Anodised<br/>908mm length</p> <p><b>DRWSA144</b><br/>Satin Anodised<br/>3660mm length</p> <p><b>CRL Satin Anodised Pile Weatherstrip for Single Door Rail</b></p> <ul style="list-style-type: none"> <li>• Specially designed to help reduce air and water infiltration</li> <li>• Fits all CRL door rails</li> <li>• Available in two finishes</li> </ul>                                                                                                                                                                                       |
|    | <p><b>W12SAS</b><br/>Satin Anodised</p> <p><b>W12PSS</b><br/>Polished Stainless</p> <p><b>W34SAS</b><br/>Satin Anodised</p> <p><b>W34PSS</b><br/>Polished Stainless</p> <p><b>CRL Vertical Weatherstile Kits</b></p> <ul style="list-style-type: none"> <li>• W12SXX for 12mm glass</li> <li>• WS34XX for 19mm glass</li> <li>• 2 lengths of Weatherstile with wool pile strip</li> <li>• 1 x black EPDM filler for double doors</li> <li>• 2.97m length</li> </ul>                                                                                                         |
|   | <p><b>SR4SBS3812SL</b><br/>Brushed Stainless Rail</p> <p><b>SR4SPS3812SL</b><br/>Polished Stainless Rail</p> <p><b>CRL Brushed Stainless 3.05m Length Square Sidelite Rail</b></p> <ul style="list-style-type: none"> <li>• Nine standard architectural finishes, custom finishes, and powder painting</li> <li>• Top load roll-in gasket for 10 and 12mm glass (included for 12mm)</li> <li>• Extruded saddle is reversible to match 6mm 19mm door clearances</li> <li>• Match door rails for even sightline</li> <li>• 15 or 19mm available on special request</li> </ul> |
|  | <p><b>SREC4SBS</b><br/>Brushed Stainless</p> <p><b>SREC4SPS</b><br/>Polished Stainless</p> <p><b>CRL Brushed Stainless 102mm Square End Cap for Sidelite Rails</b></p> <ul style="list-style-type: none"> <li>• Several finishes available to match CRL Sidelite Rails</li> <li>• For 102mm square sidelite rails</li> <li>• Heavy forged castings</li> </ul>                                                                                                                                                                                                               |
|  | <p><b>GG38100</b><br/>Black</p> <p><b>CRL 10mm Roll-In EPDM Gasket for Sidelite Rails</b></p> <ul style="list-style-type: none"> <li>• Dry glaze push-in top load glazing gasket</li> <li>• 30.5m roll</li> <li>• For 10mm glass</li> </ul>                                                                                                                                                                                                                                                                                                                                 |
|  | <p><b>UCSB4</b></p> <p><b>CRL Aluminium/Neoprene Setting Block for Glass</b></p> <ul style="list-style-type: none"> <li>• Protects glass edge while providing rigid glass support in sidelite rails and U-Channel</li> <li>• Provides proper height for recommended glass coverage</li> </ul>                                                                                                                                                                                                                                                                               |

|                                                                                     | CODE                                  | DESCRIPTION                                                                                                                                                                                                                                                                                |
|-------------------------------------------------------------------------------------|---------------------------------------|--------------------------------------------------------------------------------------------------------------------------------------------------------------------------------------------------------------------------------------------------------------------------------------------|
|    | <b>PTH311BS</b><br>Brushed Stainless  | <b>CRL Glass Mounted Latch with Lock and Thumbturn Cylinder</b> <ul style="list-style-type: none"> <li>• Works on single or double doors</li> <li>• For 10 or 12mm glass</li> <li>• Field reversible</li> <li>• 304 grade stainless steel</li> <li>• Lever handles not included</li> </ul> |
|                                                                                     | <b>PTH311PS</b><br>Polished Stainless |                                                                                                                                                                                                                                                                                            |
|    | <b>PTH312BS</b><br>Brushed Stainless  | <b>CRL Glass Mounted Passage Latch</b> <ul style="list-style-type: none"> <li>• Works on single or double doors</li> <li>• For 10 or 12mm glass</li> <li>• 304 grade stainless steel</li> <li>• Lever handles not included</li> </ul>                                                      |
|                                                                                     | <b>PTH312PS</b><br>Polished Stainless |                                                                                                                                                                                                                                                                                            |
|   | <b>PTH314BS</b><br>Brushed Stainless  | <b>CRL PTH Series Glass Mounted Long Patch Lock Keeper</b> <ul style="list-style-type: none"> <li>• For use with 10mm or 12mm thick glass</li> <li>• Stamped body with finished cover plates</li> <li>• Works with either latch above on double doors</li> </ul>                           |
|                                                                                     | <b>PTH314PS</b><br>Polished Stainless |                                                                                                                                                                                                                                                                                            |
|  | <b>PTH303BS</b><br>Brushed Stainless  | <b>CRL Extended Length Keyed Cylinder/Cylinder</b> <ul style="list-style-type: none"> <li>• For use with PTH311 and PTH312 glass mounted latch mechanisms</li> <li>• Available in three finishes</li> <li>• Includes: hex wrench</li> </ul>                                                |
|                                                                                     | <b>PTH303PS</b><br>Polished Stainless |                                                                                                                                                                                                                                                                                            |
|  | <b>PTH302BS</b><br>Brushed Stainless  | <b>CRL PTH Series Tubular Style Lever Handle</b> <ul style="list-style-type: none"> <li>• For use with PTH311 and PTH312 glass mounted latch mechanisms</li> <li>• Includes: hex wrench</li> <li>• Available in four finishes</li> </ul>                                                   |
|                                                                                     | <b>PTH302PS</b><br>Polished Stainless |                                                                                                                                                                                                                                                                                            |
|  | <b>PTH306BS</b><br>Brushed Stainless  | <b>CRL PTH Series Modern Style Lever Handle</b> <ul style="list-style-type: none"> <li>• For use with PTH311 and PTH312 glass mounted latch mechanisms</li> <li>• Includes: hex wrench</li> <li>• Available in four finishes</li> </ul>                                                    |
|                                                                                     | <b>PTH306PS</b><br>Polished Stainless |                                                                                                                                                                                                                                                                                            |

|                                                                                     | CODE                                            | DESCRIPTION                                                                                                                                                                                                                                                                                                                                                                                                                        |
|-------------------------------------------------------------------------------------|-------------------------------------------------|------------------------------------------------------------------------------------------------------------------------------------------------------------------------------------------------------------------------------------------------------------------------------------------------------------------------------------------------------------------------------------------------------------------------------------|
|    | <b>DL410LBS</b><br>Brushed Stainless<br>LH/RHR  | <b>CRL 101.6 x 254mm Centre Lock with Deadlatch</b> <ul style="list-style-type: none"> <li>• For use with 12mm toughened glass</li> <li>• Installs easily with bolts; no silicone or cement required</li> <li>• Available in five stock finishes</li> <li>• Custom sizes for other glass thicknesses and custom finishes can be special ordered</li> </ul>                                                                         |
|                                                                                     | <b>DL410RBS</b><br>Brushed Stainless<br>RH/LHR  |                                                                                                                                                                                                                                                                                                                                                                                                                                    |
|                                                                                     | <b>DL410LPS</b><br>Polished Stainless<br>LH/RHR |                                                                                                                                                                                                                                                                                                                                                                                                                                    |
|                                                                                     | <b>DL410RPS</b><br>Polished Stainless<br>RH/LHR |                                                                                                                                                                                                                                                                                                                                                                                                                                    |
|    | <b>DLK410BS</b><br>Brushed Stainless            | <b>CRL 101.6 x 254mm Centre Lock Glass Keepers</b> <ul style="list-style-type: none"> <li>• For use with 12mm toughened glass</li> <li>• Installs easily with bolts; no silicone or cement required</li> <li>• Non-handed stock models available in five standard finishes</li> <li>• Custom sizes for other glass thicknesses and custom</li> </ul>                                                                               |
|                                                                                     | <b>DLK410PS</b><br>Polished Stainless           |                                                                                                                                                                                                                                                                                                                                                                                                                                    |
|  | <b>DT410BS</b><br>Brushed Stainless             | <b>CRL Centre Lock with Long Throw Deadlock</b> <ul style="list-style-type: none"> <li>• Non-handed stock models available in five finishes</li> <li>• Installs easily with bolts; no silicone or cement required</li> <li>• For use with 12mm toughened glass</li> <li>• Custom sizes for 10mm toughened glass are available on special order</li> </ul>                                                                          |
|                                                                                     | <b>DT410PS</b><br>Polished Stainless            |                                                                                                                                                                                                                                                                                                                                                                                                                                    |
|  | <b>DH410BS</b><br>Brushed Stainless             | <b>CRL Centre Lock with Hook Throw Deadlock</b> <ul style="list-style-type: none"> <li>• Non-handed stock models available in five finishes</li> <li>• Installs easily with bolts; no silicone or cement required</li> <li>• For use with 12mm toughened glass</li> <li>• Custom sizes for 10mm toughened glass are available on special order</li> </ul>                                                                          |
|                                                                                     | <b>DH410PS</b><br>Polished Stainless            |                                                                                                                                                                                                                                                                                                                                                                                                                                    |
|  | <b>DTK410BS</b><br>Brushed Stainless            | <b>CRL Glass Keepers for Centre Locks with Long Throw and Hook Throw Deadlocks</b> <ul style="list-style-type: none"> <li>• Non-handed stock models available in five finishes</li> <li>• Installs easily with bolts; no silicone or cement required</li> <li>• For use with 12mm toughened glass</li> <li>• Custom sizes for 10mm toughened glass are available on special order</li> <li>• Available in four finishes</li> </ul> |
|                                                                                     | <b>DTK410PS</b><br>Polished Stainless           |                                                                                                                                                                                                                                                                                                                                                                                                                                    |

| CODE                                                                                | DESCRIPTION                            |
|-------------------------------------------------------------------------------------|----------------------------------------|
|   | <b>24LPBS</b><br>Brushed Stainless     |
|                                                                                     | <b>24LPPS</b><br>Polished Stainless    |
|                                                                                     | <b>36LPBS</b><br>Brushed Stainless     |
|                                                                                     | <b>36LPPS</b><br>Polished Stainless    |
|                                                                                     | <b>42LPBS</b><br>Brushed Stainless     |
|                                                                                     | <b>42LPPS</b><br>Polished Stainless    |
|                                                                                     | <b>48LPBS</b><br>Brushed Stainless     |
|                                                                                     | <b>48LPPS</b><br>Polished Stainless    |
|                                                                                     | <b>60LPBS</b><br>Brushed Stainless     |
|                                                                                     | <b>60LPPS</b><br>Polished Stainless    |
|                                                                                     | <b>72LPBS</b><br>Brushed Stainless     |
|                                                                                     | <b>72LPPS</b><br>Polished Stainless    |
|                                                                                     | <b>84LPBS</b><br>Brushed Stainless     |
|                                                                                     | <b>84LPPS</b><br>Polished Stainless    |
|  | <b>CM10X10BS</b><br>Brushed Stainless  |
|                                                                                     | <b>CM10X10PS</b><br>Polished Stainless |
|  | <b>SQ10X10BS</b><br>Brushed Stainless  |
|                                                                                     | <b>SQ10X10PS</b><br>Polished Stainless |



|                                                                                     | CODE                                                                                           | DESCRIPTION                                                                                                                                                                                                                                                             |
|-------------------------------------------------------------------------------------|------------------------------------------------------------------------------------------------|-------------------------------------------------------------------------------------------------------------------------------------------------------------------------------------------------------------------------------------------------------------------------|
|    | <p><b>RST10X10BS</b><br/>Brushed Stainless</p> <p><b>RST10X10PS</b><br/>Polished Stainless</p> | <p><b>CRL Glass Mounted Rounded Corner Square Tube Style Back-to-Back Pull Handle</b></p> <ul style="list-style-type: none"> <li>• For 10 and 19mm glass</li> <li>• Includes mounting hardware</li> <li>• Available in four sizes and two finishes</li> </ul>           |
|    | <p><b>LLP059BS</b><br/>Brushed Stainless</p>                                                   | <p><b>CRL 1499mm Locking Ladder Pull</b></p> <ul style="list-style-type: none"> <li>• Locks into the floor only</li> <li>• Lock operates at a comfortable 1200mm above the floor</li> <li>• 35mm diameter alloy 316 brushed stainless steel tubing</li> </ul>           |
|   | <p><b>LLP084BS</b><br/>Brushed Stainless</p>                                                   | <p><b>CRL 2134mm Double Locking Ladder Pull</b></p> <ul style="list-style-type: none"> <li>• Locks at both top and bottom</li> <li>• Lock operates at a comfortable 1200mm above the floor</li> <li>• 35mm diameter alloy 316 brushed stainless steel tubing</li> </ul> |
|  | <p><b>LPK1BS</b><br/>Brushed Stainless</p>                                                     | <p><b>35mm Diameter Brushed Stainless Ladder Keeper</b></p> <ul style="list-style-type: none"> <li>• 35mm diameter alloy 316 brushed stainless steel tubing</li> </ul>                                                                                                  |
|  | <p><b>58DKBS</b><br/>Chrome Plated</p>                                                         | <p><b>CRL Chrome Plated Brass 16mm Dust Proof Keeper for Locking Ladder Pulls</b></p> <ul style="list-style-type: none"> <li>• For CRL locking ladder pulls</li> <li>• Accepts 16mm throw bolt</li> <li>• Chrome plated brass</li> </ul>                                |

# Internal Door Hinges



For more information call FREE on





**00 800 0421 6144**

e: [CRL@crlaurence.co.uk](mailto:CRL@crlaurence.co.uk) f: 00 800 0262 3299



|                                                                                     | CODE                              | DESCRIPTION                                                                                                                                                                                                                                                                                                                                                                                                                                                                  |
|-------------------------------------------------------------------------------------|-----------------------------------|------------------------------------------------------------------------------------------------------------------------------------------------------------------------------------------------------------------------------------------------------------------------------------------------------------------------------------------------------------------------------------------------------------------------------------------------------------------------------|
|    | <b>31M8010CH</b><br>Chrome        | <b>CRL Biloba Full Back Plate Wall-to-Glass Hinge</b> <ul style="list-style-type: none"> <li>• For self-closing glass doors from 8 to 12mm thick</li> <li>• Recommended for use as entry doors to bathroom/shower area</li> <li>• Aluminium body in your choice of three finishes: brite chrome, brushed satin, and satin anodised</li> <li>• Hold open or no hold open models</li> <li>• Adjustable closing speed</li> <li>• Other finishes available on request</li> </ul> |
|                                                                                     | <b>31M8010SN</b><br>Brushed Satin |                                                                                                                                                                                                                                                                                                                                                                                                                                                                              |
|    | <b>31M8015CH</b><br>Chrome        | <b>CRL Biloba 180° Glass-to-Glass Hinge</b> <ul style="list-style-type: none"> <li>• For self-closing glass doors from 8 to 12mm thick</li> <li>• Recommended for use as entry doors to bathroom/shower area</li> <li>• Aluminium body in your choice of three finishes: brite chrome, brushed satin, and satin anodised</li> <li>• Hold open or no hold open models</li> <li>• Adjustable closing speed</li> <li>• Other finishes available on request</li> </ul>           |
|                                                                                     | <b>31M8015SN</b><br>Brushed Satin |                                                                                                                                                                                                                                                                                                                                                                                                                                                                              |
|   | <b>31M8060CH</b><br>Chrome        | <b>CRL Biloba 8060 Hydraulic All-Glass Door Hinge</b> <ul style="list-style-type: none"> <li>• For self-closing glass doors from 8 to 12mm thick</li> <li>• Recommended for use as entry doors to bathroom/shower area</li> <li>• Aluminium body in your choice of three finishes: brite chrome, brushed satin, and satin anodised</li> <li>• Hold open or no hold open models</li> <li>• Adjustable closing speed</li> <li>• Other finishes available on request</li> </ul> |
|                                                                                     | <b>31M8060SN</b><br>Brushed Satin |                                                                                                                                                                                                                                                                                                                                                                                                                                                                              |
|  | <b>PTH350CH</b><br>Chrome         | <b>CRL Barcelona Free Swinging Interior Door Hinge</b> <ul style="list-style-type: none"> <li>• 8 or 10mm toughened glass</li> <li>• Glass fabrication - two 8mm holes required per hinge</li> <li>• Solid brass construction</li> <li>• Mounting brackets ordered separately</li> <li>• Available in polished chrome, polished brass, and brushed nickel finishes</li> <li>• Other finishes available on request</li> </ul>                                                 |
|                                                                                     | <b>PTH350BR</b><br>Brushed Nickel |                                                                                                                                                                                                                                                                                                                                                                                                                                                                              |
|  | <b>PTH351CH</b><br>Chrome         | <b>CRL Roma Free Swinging Interior Door Hinge</b> <ul style="list-style-type: none"> <li>• 8 or 10mm toughened glass</li> <li>• Solid brass construction</li> <li>• Available in polished chrome, polished brass, and brushed nickel finishes</li> <li>• Mounting brackets ordered separately</li> <li>• Other finishes available on request</li> </ul>                                                                                                                      |
|                                                                                     | <b>PTH351BN</b><br>Brushed Nickel |                                                                                                                                                                                                                                                                                                                                                                                                                                                                              |



| CODE                                                                                                                   | DESCRIPTION                                                                                                                                                                                                                                                                                                           |
|------------------------------------------------------------------------------------------------------------------------|-----------------------------------------------------------------------------------------------------------------------------------------------------------------------------------------------------------------------------------------------------------------------------------------------------------------------|
| <b>PTH352SA</b><br>Satin Anodised     | <b>CRL Valencia Free Swinging Interior Door Hinge</b> <ul style="list-style-type: none"> <li>• 8 or 10mm toughened glass</li> <li>• Solid aluminium construction</li> <li>• Satin anodised finish</li> </ul>                                                                                                          |
| <b>PTH360</b><br>Surface Mount        | <b>CRL Euro Series Mounting Brackets for Free Swinging Interior Hinges</b> <ul style="list-style-type: none"> <li>• CRL steel frame mount euro series mounting bracket for free swinging interior door hinge</li> <li>• Three models available to fit euro series door hinges</li> <li>• Zinc plated steel</li> </ul> |
| <b>PTH361</b><br>Steel Frame Mount  | <b>CRL Euro Series Mounting Brackets for Free Swinging Interior Hinges</b> <ul style="list-style-type: none"> <li>• CRL steel frame mount euro series mounting bracket for free swinging interior door hinge</li> <li>• Three models available to fit euro series door hinges</li> <li>• Zinc plated steel</li> </ul> |
| <b>PTH362</b><br>Surface Mount      | <b>CRL Euro Series Mounting Brackets for Free Swinging Interior Hinges</b> <ul style="list-style-type: none"> <li>• CRL steel frame mount euro series mounting bracket for free swinging interior door hinge</li> <li>• Three models available to fit euro series door hinges</li> <li>• Zinc plated steel</li> </ul> |
| <b>PTH353SA</b><br>Satin Anodised   | <b>CRL Sofia Free Swinging Interior Door Hinge</b> <ul style="list-style-type: none"> <li>• 8 or 10mm toughened glass</li> <li>• Solid aluminium construction</li> <li>• Satin anodised finish</li> </ul>                                                                                                             |



# Sliding Doors

For more information call FREE on

**00 800 0421 6144**

e: [CRL@crlaurence.co.uk](mailto:CRL@crlaurence.co.uk) f: 00 800 0262 3299



**CRL**<sup>®</sup>  
crlaurence.co.uk

# CRL280 Series Top Hung Sliding Door System



- Sleek design
- No notches or holes required in the glass for installation
- Designed for use with 8, 10, or 12mm toughened glass
- Rated for doors weighing up to 80kg

The new CRL280 series Top Hung Sliding Door System is truly the most versatile system of its kind. There are six different kits to choose from, offering configurations with or without fixed panels, and the ability to mount either to the wall, ceiling or glass panels.

The CRL280 System has no bottom track, so a tripping hazard is eliminated, and the smooth sliding action allows for finger touch control. The upper clamp and roller assemblies have a fine tune adjustment feature allowing for openings and floors that are not true and level. Each kit comes with concealed stops in the top track to hold the door open or closed.

Kits are available in a satin anodised finish, with a special order option to clad or powder paint in any architectural finish desired.

**Soft Brake Available.**



## Available CRL280 Kits

- Kits contain all necessary hardware to complete the installation
- Rollers have up to 6mm of vertical adjustment to aid in door alignment after installation
- Satin anodised finish

There are three configurations of CRL280 Series Kits. All come with everything you need (except the toughened glass) to complete the installation. Kits are available in a satin anodised finish, with a special order option to clad or powder paint in any architectural finish desired. Contact technical sales for commercial products for kit selection or installation assistance.

**NOTE:** Laminated glass should not be used with the CRL280 Series.

### Single Sliding Door Kits for 8 to 10mm Toughened Glass

| CAT. NO. | KIT DESCRIPTION                                                         |
|----------|-------------------------------------------------------------------------|
| CRL2810  | Single sliding door wall or ceiling mount installation                  |
| CRL2810F | Single sliding door with fixed panel wall or ceiling mount installation |
| CRL2810G | Single sliding door glass fixed panel mount installation                |

### Single Sliding Door Kits for 12mm Toughened Glass

| CAT. NO. | KIT DESCRIPTION                                                         |
|----------|-------------------------------------------------------------------------|
| CRL2812  | Single sliding door wall or ceiling mount installation                  |
| CRL2812F | Single sliding door with fixed panel wall or ceiling mount installation |
| CRL2812G | Single sliding door glass fixed panel mount installation                |

Minimum order: 1 each. Kits contain stock lengths of Top Track measuring 3m in length, and therefore must ship common carrier. Kits can be combined for quantity pricing.

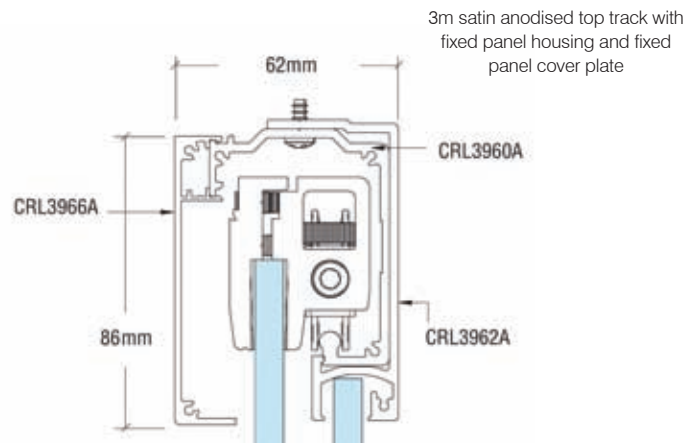
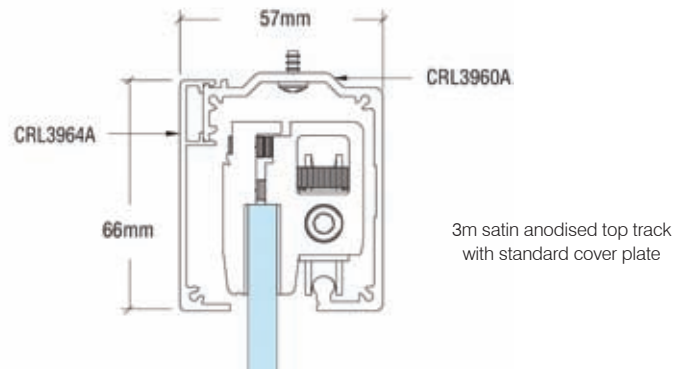

## CRL50 Series Top Hung Sliding Door Systems



- Models for single doors, synchronized doors, and telescoping doors
- For use with 8 or 10mm toughened glass
- No notches or holes required in the glass
- Mounts to wall or ceiling
- Can accommodate doors weighing up to 80kg

**Soft Brake Available.**

The new CRL50 Series Top Hung Sliding Door Systems feature a sleek design that offers options for wall or ceiling mount for sliding glass doors with or without fixed panels. These top hung systems require no bottom track and the smooth sliding action allows for finger touch control.

The upper clamp and roller assemblies offer 6mm of height adjustment during installation to allow for openings and floors that are not true and level. Kits come with concealed roller stops in the top track to hold the door in the open or closed position, a small bottom guide, and are available in a satin anodised finish with an option for powder paint or cladding in any architectural finish desired.

CRL50 Systems are also available with optional 'synchronization' of bi-parting doors where the operation of one panel moves the others. A 'telescoping' option is also available where the panels slide in the same direction and stack away together. You can also enjoy the best of both with our combination 'synchronized' and 'telescoping' options all in one.

Contact technical sales for commercial products for assistance with proper kit selection or installation instruction assistance.

**NOTE:** Laminated glass should not be used with the CRL50 System.



## CRL Sliding Door Systems Brochure

**For further information on our sliding door systems please see our sliding door brochure SDS12UK**



# CRL Laguna Series Sliding Glass Door System with Anti-Lift Safety Features



Typical Wall Mount Installation

Soft close options available. Cat. No's. LSDSRH (right hand) & LSDSLH (left hand). Please call for details.

- New anti-lift features for added safety
- All 316 alloy brushed stainless steel construction
- Ideal for interior applications
- For use with 10 or 12mm glass
- Comes with all fasteners needed for either flush (countersunk) or surface (straight hole) mounting
- Custom adaptor kits available for wood door applications

We have upgraded our popular Laguna Series Sliding Glass Door System to now include a new 'anti-lift' feature. Through a combination of additions and very subtle changes, we have improved the performance, safety, and security while still offering a clean, simple look. The Laguna Series Sliding Glass Door System can be installed on glass partitions or directly to the side of a sufficiently reinforced wall. The adjustable Top Rollers make final adjustments quick and easy, without the need to remove the door. Their smooth operation and solid stainless steel construction minimizes maintenance issues.

CRL provides you with all the glass attachment fasteners for either flush mounting, requiring a countersunk hole, or surface mounting, requiring a straight hole. The glass attachment fasteners accommodate either 10 or 12mm toughened glass.

NOTE: Laminated glass cannot be used in these systems.

## CODE / Description

**LSWM3BS** Single Sliding Door Wall Mount Installation

**LSWM4BS** Double Sliding Door Wall Mount Installation

**LSGM3BS** Single Sliding Glass Mount Installation Assembly

**LSGM4BS** Single Sliding Door with Sidelites Glass Mount Installation Assembly





# CRL Overhead Track Half Panel Bi-Fold Door System



- With 101.6mm square DR4S series door rails
- Panels hung from mid-point, maximizing panel width
- Available in six architectural finishes

CRL Overhead Track Half Panel Bi-Fold Door Systems are available in four configurations, with a maximum of three panels on each side of the opening.

The end panels act like normal centre pivoting doors and connect to the first hanging panel using special hinged end caps. The hanging panels are joined in the same manner, and are hung from a single Cat. No. OTCA Carriage Assembly at the midpoint of the panel's width.

Use of our Cat. No. OTBR Series Guide Channel supplied with each order is highly recommended to prevent the panels from dragging during operation.

Maximum panel weight not to exceed 77kg.

Maximum panel width is 1041mm.

Minimum panel width is 381mm.

**NOTE:** Available with 101.6mm square rails, and by custom order only.

| CODE | DESCRIPTION |
|------|-------------|
|------|-------------|

|        |                            |
|--------|----------------------------|
| OTC2XX | Half Leaf Bi-Fold 2 Panels |
|--------|----------------------------|

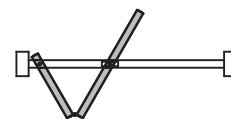
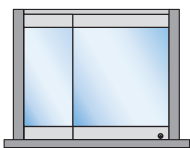

|        |                            |
|--------|----------------------------|
| OTC3XX | Half Leaf Bi-Fold 3 Panels |
|--------|----------------------------|

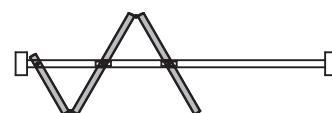
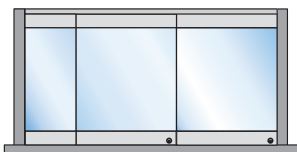

|        |                                   |
|--------|-----------------------------------|
| OTC4XX | Half Leaf Bi-Fold 4 Panels Bipart |
|--------|-----------------------------------|

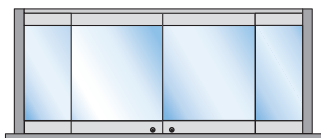

|        |                                   |
|--------|-----------------------------------|
| OTC6XX | Half Leaf Bi-Fold 6 Panels Bipart |
|--------|-----------------------------------|

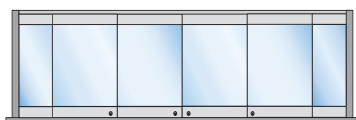

# CRL Overhead Track Full Panel Bi-Fold Door System



- With 101.6mm square DR4S series door rails
- Panels hung from end point, minimizing obstruction
- Custom built to your specs for fit and finish

CRL Overhead Track Full Panel Bi-Fold Door Systems are available in four configurations, with a maximum of three panels on each side of the opening. The end panels act like normal centre pivoting doors and connect to the first hanging panel using special hinged end caps. The hanging panels are joined in the same manner, and are hung from a single Cat. No. 0TCA Carriage Assembly at the panel's end point.

Use of our Cat. No. 0TBR Series Guide Channel supplied with each order is highly recommended to prevent the panels from dragging during operation.

Maximum panel weight not to exceed 77kg.

Maximum panel width is 990mm.

Minimum panel width is 381mm.

**NOTE:** Available with 101.6mm square rails, and by custom order only.

| CODE | DESCRIPTION |
|------|-------------|
|------|-------------|

|        |                            |
|--------|----------------------------|
| OTB2XX | Full Leaf Bi-Fold 2 Panels |
|--------|----------------------------|

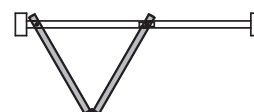
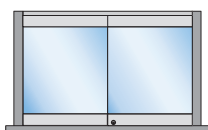

|        |                            |
|--------|----------------------------|
| OTB3XX | Full Leaf Bi-Fold 3 Panels |
|--------|----------------------------|

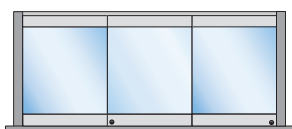

|        |                                   |
|--------|-----------------------------------|
| OTB4XX | Full Leaf Bi-Fold 4 Panels Bipart |
|--------|-----------------------------------|

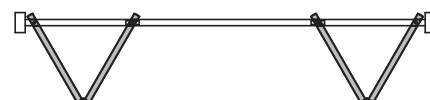

|        |                                   |
|--------|-----------------------------------|
| OTB6XX | Full Leaf Bi-Fold 6 Panels Bipart |
|--------|-----------------------------------|





A modern office interior featuring glass partitioning systems. The foreground shows a grey carpeted area with a glass wall. In the background, a meeting room is visible through a glass door, containing a glass table, black chairs, and a whiteboard. The ceiling has recessed lighting.

# Partitioning Systems

For more information call FREE on





**00 800 0421 6144**





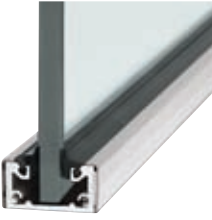

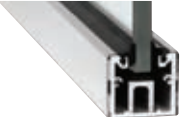
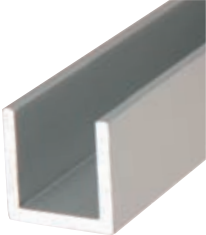
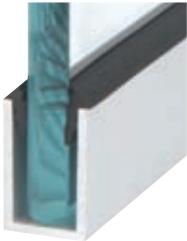
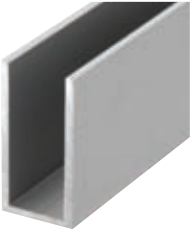
e: [CRL@crlaurence.co.uk](mailto:CRL@crlaurence.co.uk) f: 00 800 0262 3299



**CRL**<sup>®</sup>  
crlaurence.co.uk



|                                                                                                                                                                        | CODE                                                    | DESCRIPTION                                                                                                                                                                                                                                                                                                                                                                                                                                                                                                                                                    |
|------------------------------------------------------------------------------------------------------------------------------------------------------------------------|---------------------------------------------------------|----------------------------------------------------------------------------------------------------------------------------------------------------------------------------------------------------------------------------------------------------------------------------------------------------------------------------------------------------------------------------------------------------------------------------------------------------------------------------------------------------------------------------------------------------------------|
|                                                                                       | <b>SCSA3812SL</b><br>Satin Anodised<br>41.3 x 17.5mm    | <b>CRL Shallow U-Channel with Top Load Roll-in Glazing Gasket</b> <ul style="list-style-type: none"> <li>• Uses top loading roll-in glazing gasket for 10 and 12mm glass</li> <li>• Gasket included for 12mm glass</li> <li>• Ideal for recessed 'all-glass' installations</li> <li>• Ready-to-ship models from CRL inventory</li> <li>• Nine standard architectural finishes - see <a href="http://crlaurence.co.uk">crlaurence.co.uk</a></li> <li>• Custom finishes and powder painting available</li> <li>• 3m length - custom lengths available</li> </ul> |
|                                                                                                                                                                        | <b>SCBS3812SL</b><br>Brushed Stainless<br>41.3 x 17.5mm |                                                                                                                                                                                                                                                                                                                                                                                                                                                                                                                                                                |
| <br> | <b>UCSA3812SL</b><br>Satin Anodised<br>41.3 x 41.3mm    | <b>CRL Regular U-Channel with Top Load Roll-In Glazing Gasket</b> <ul style="list-style-type: none"> <li>• Uses top loading roll-in glazing gasket for 10 and 12mm glass</li> <li>• Gasket included for 12mm glass</li> <li>• Ideal for ceiling or floor installations</li> <li>• Ready-to-ship models from crl inventory</li> <li>• Nine standard architectural finishes - see <a href="http://crlaurence.co.uk">crlaurence.co.uk</a></li> <li>• Custom finishes and powder painting available</li> <li>• 3m length - custom lengths available</li> </ul>     |
|                                                                                                                                                                        | <b>UCBS3812SL</b><br>Brushed Stainless<br>41.3 x 41.3mm |                                                                                                                                                                                                                                                                                                                                                                                                                                                                                                                                                                |
|                                                                                      | <b>WU3SASL</b><br>Satin Anodised                        | <b>CRL Shallow 25mm Wet/Dry Glaze U-Channel</b> <ul style="list-style-type: none"> <li>• Shallow 25.4mm height</li> <li>• Available in 3m or 6m stock lengths</li> <li>• Typically used at the bottom of glass panels</li> <li>• Use with silicone (wet) or glazing gasket (dry) for 10 and 12mm glass</li> <li>• Matching end caps sold separately</li> </ul>                                                                                                                                                                                                 |
|                                                                                                                                                                        | <b>WU3BSASL</b><br>Brushed Stainless                    |                                                                                                                                                                                                                                                                                                                                                                                                                                                                                                                                                                |
|                                                                                                                                                                        | <b>WU3BASL</b><br>Brite Anodised                        |                                                                                                                                                                                                                                                                                                                                                                                                                                                                                                                                                                |
|                                                                                     | <b>WU1SASL</b><br>Satin Anodised                        | <b>CRL Deep 38mm Wet/Dry Glaze U-Channel</b> <ul style="list-style-type: none"> <li>• Deep 38mm height</li> <li>• Available in 3m or 6m stock lengths</li> <li>• Typically used at the bottom of glass panels</li> <li>• Use with silicone (wet) or glazing gasket (dry) for 10 and 12mm glass</li> <li>• Matching end caps sold separately</li> </ul>                                                                                                                                                                                                         |
|                                                                                                                                                                        | <b>WU1BSASL</b><br>Brushed Stainless                    |                                                                                                                                                                                                                                                                                                                                                                                                                                                                                                                                                                |
|                                                                                                                                                                        | <b>WU1BASL</b><br>Brite Anodised                        |                                                                                                                                                                                                                                                                                                                                                                                                                                                                                                                                                                |
|                                                                                     | <b>WU2SASL</b><br>Satin Anodised                        | <b>CRL Deep 51mm Wet/Dry Glaze U-Channel</b> <ul style="list-style-type: none"> <li>• Deep 51mm height</li> <li>• Available in 3m or 6m stock lengths</li> <li>• Typically used at the bottom of glass panels</li> <li>• Use with silicone (wet) or glazing gasket (dry) for 10 and 12mm glass</li> <li>• Matching end caps sold separately</li> </ul>                                                                                                                                                                                                         |
|                                                                                                                                                                        | <b>WU2BSASL</b><br>Brushed Stainless                    |                                                                                                                                                                                                                                                                                                                                                                                                                                                                                                                                                                |
|                                                                                                                                                                        | <b>WU2BASL</b><br>Brite Anodised                        |                                                                                                                                                                                                                                                                                                                                                                                                                                                                                                                                                                |
|                                                                                     | <b>SDCR12BA</b><br>Brite Anodised                       | <b>Fixed Panel Regular U-Channel</b> <ul style="list-style-type: none"> <li>• 10mm low profile</li> <li>• For 12mm thick glass</li> <li>• 2.49m stock length</li> <li>• Available in 6 finishes - see <a href="http://crlaurence.co.uk">crlaurence.co.uk</a></li> </ul>                                                                                                                                                                                                                                                                                        |
|                                                                                                                                                                        | <b>SDCR38BA</b><br>Brite Anodised<br>10mm Glass         |                                                                                                                                                                                                                                                                                                                                                                                                                                                                                                                                                                |

| CODE                                                                                | DESCRIPTION                                                                                                                                                                                                                                                                                                                                                                                                                                                                                           |
|-------------------------------------------------------------------------------------|-------------------------------------------------------------------------------------------------------------------------------------------------------------------------------------------------------------------------------------------------------------------------------------------------------------------------------------------------------------------------------------------------------------------------------------------------------------------------------------------------------|
|    | <p><b>SDCD38BA</b><br/>Brite Anodised<br/>10mm Glass</p> <p><b>SDCD12BA</b><br/>Brite Anodised<br/>12mm Glass</p> <p><b>Fixed Panel Deep U-Channel</b></p> <ul style="list-style-type: none"> <li>• 19mm high profile</li> <li>• Available in 2.49m and 3.65m stock lengths</li> <li>• Available in 17 finishes - see <a href="http://crlaurence.co.uk">crlaurence.co.uk</a></li> </ul>                                                                                                               |
|    | <p><b>SCECSA</b><br/>Satin Anodised</p> <p><b>SCECBS</b><br/>Brushed Stainless</p> <p><b>CRL Shallow U-Channel End Caps</b></p> <ul style="list-style-type: none"> <li>• Finishes to match our shallow U-Channel</li> </ul>                                                                                                                                                                                                                                                                           |
|   | <p><b>UCECSA</b><br/>Satin Anodised</p> <p><b>UCECBS</b><br/>Brushed Stainless</p> <p><b>CRL U-Channel End Caps</b></p> <ul style="list-style-type: none"> <li>• Several finishes to match CRL U-Channel with roll-in top load gasket</li> <li>• For use with "UC3800" series channels</li> <li>• Our CRL end caps with screws are used to finish the installation of CRL U-Channels with roll-in top load gasket.</li> </ul>                                                                         |
|  | <p><b>WU3ECSA</b><br/>Satin Anodised</p> <p><b>WU3ECBSA</b><br/>Brushed Stainless</p> <p><b>WU3ECBA</b><br/>Brite Anodised</p> <p><b>CRL End Caps for WU3 Shallow 25mm U-Channel</b></p> <ul style="list-style-type: none"> <li>• Fits WU3 shallow 25mm wet/dry glaze U-Channels</li> <li>• Easy-to-install with silicone sealant</li> <li>• Fits WU3SASL and WU3SA240</li> <li>• Finishes off exposed ends</li> <li>• Six standard architectural finishes, with custom finishes available</li> </ul> |
|  | <p><b>WU1ECSA</b><br/>Satin Anodised</p> <p><b>WU1ECBSA</b><br/>Brushed Stainless</p> <p><b>WU1ECBA</b><br/>Brite Anodised</p> <p><b>CRL End Caps for WU1 Deep 38mm U-Channel</b></p> <ul style="list-style-type: none"> <li>• Fits WU1 deep 38mm wet/dry glaze U-Channels</li> <li>• Easy-to-install with silicone sealant</li> <li>• Finishes off exposed ends</li> <li>• Six standard architectural finishes, with custom finishes available</li> </ul>                                            |
|  | <p><b>WU2ECSA</b><br/>Satin Anodised</p> <p><b>WU2ECBSA</b><br/>Brushed Stainless</p> <p><b>WU2ECBA</b><br/>Brite Anodised</p> <p><b>CRL End Caps for WU2 Deep 51mm U-Channel</b></p> <ul style="list-style-type: none"> <li>• Fits WU2 deep 51mm wet/dry glaze U-Channels</li> <li>• Easy-to-install with silicone sealant</li> <li>• Finishes off exposed ends</li> <li>• Six standard architectural finishes, with custom finishes available</li> </ul>                                            |

## CODE

## DESCRIPTION



### SDCEC38CH

Chrome  
10mm Glass

### SDCEC12CH

Chrome  
12mm Glass

### U-Channel End Caps

- For use with U-Channels
- Available in 8 finishes - see [crlaurence.co.uk](http://crlaurence.co.uk)



### GG38100

10mm Glass  
30m Length Roll

### GG12100

12mm Glass  
30m Length Roll

### CRL Roll-In EPDM Gasket

- Dry glaze push-in top load glazing gasket
- This CRL glazing gasket is used to dry glaze 10mm glass in CRL sidelite rails and CRL U-Channel with roll-in top load gasket materials.
- For use with SC/UC channels
- 152.4mm roll also available - see [crlaurence.co.uk](http://crlaurence.co.uk)

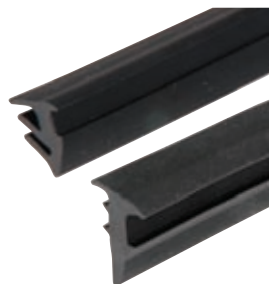

### RG38100

10mm Glass  
30m Length Roll

### RG12100

12mm Glass  
30m Length Roll

### CRL Roll-In Glazing Gasket

- Roll-in glazing gasket for 10mm and 12mm glass
- Eliminates the need for silicone
- Black colour material can be used with all finishes of our wet/dry U-Channel.
- 152.4mm roll also available - see [crlaurence.co.uk](http://crlaurence.co.uk)
- For use with WU3, WU1, WU2 channel

### SB579



### CRL Neoprene Setting Blocks

- The preferred method for centring and cushioning glass
- 80 durometer hardness
- Special sizes and hardnesses available



### EZCC10

10mm Standard Glass  
10.8 Laminated Glass

### EZCC12

12mm Standard Glass  
12.8 Laminated Glass

### CRL Glass Partition Joints

- For use with standard or laminated glass
- A great alternative to silicone to achieve a clear slimline joint between glass panels
- Increased UV stability





# Spider Fittings & Bolts

For more information call FREE on

**00 800 0421 6144**





e: [CRL@crlaurence.co.uk](mailto:CRL@crlaurence.co.uk) f: 00 800 0262 3299



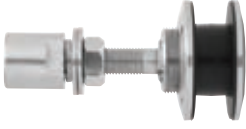

**CRL**<sup>®</sup>  
crlaurence.co.uk

# CRL Heavy Duty Spider Fittings

|                                                                                     | CODE                                         | DESCRIPTION                                                                                                                                                                                                                                                                                                                                                                                                                              |
|-------------------------------------------------------------------------------------|----------------------------------------------|------------------------------------------------------------------------------------------------------------------------------------------------------------------------------------------------------------------------------------------------------------------------------------------------------------------------------------------------------------------------------------------------------------------------------------------|
|    | <b>HRF14BS</b><br>Brushed Stainless          | <b>CRL Rigid Head Combination Glass Attachment</b> <ul style="list-style-type: none"> <li>• For use with 12 to 27mm toughened glass</li> <li>• The rigid head attachments allow for a secure attachment and minimize the deflection of the glass panels</li> <li>• Typically used only for interior applications</li> <li>• 'Flush' or 'cap' mount</li> </ul>                                                                            |
|                                                                                     | <b>HRF14PS</b><br>Polished Stainless         |                                                                                                                                                                                                                                                                                                                                                                                                                                          |
|    | <b>HSF14BS</b><br>Brushed Stainless          | <b>CRL Swivel Head Combination Glass Attachment</b> <ul style="list-style-type: none"> <li>• For use with 12 to 27mm toughened glass</li> <li>• The head of the swivel glass attachment can tilt up to 6 degrees in any direction on its ball and socket joint minimising stress applied to the glass</li> <li>• Typically used in conditions where the glass will be subject to live loads</li> <li>• 'Flush' or 'cap' mount</li> </ul> |
|                                                                                     | <b>HSF14PS</b><br>Polished Stainless         |                                                                                                                                                                                                                                                                                                                                                                                                                                          |
|   | <b>RRF14RW</b><br>Rigid Glass Attachment     | <b>CRL Replacement Gasket Set</b> <ul style="list-style-type: none"> <li>• Replace worn or lost gaskets for Cat. No. HRF14BS and HSF14BS/PS</li> </ul>                                                                                                                                                                                                                                                                                   |
|                                                                                     | <b>RSF14RW</b><br>Swivel Glass Attachment    |                                                                                                                                                                                                                                                                                                                                                                                                                                          |
|  | <b>HSFEX14BS</b><br>Exterior Swivel Fastener | <b>CRL Brushed Stainless Heavy-Duty Fasteners</b> <ul style="list-style-type: none"> <li>• Designed for the "All Glass Look"</li> <li>• HSFEX14BS for use with 12 to 22mm toughened glass</li> <li>• HS1GF14BS for use with 32mm toughened glass</li> </ul>                                                                                                                                                                              |
|                                                                                     | <b>HS1GF14BS</b><br>Insulated Glass Fastener |                                                                                                                                                                                                                                                                                                                                                                                                                                          |
|  | <b>PMH1BS</b><br>Brushed Stainless           | <b>CRL Single Arm Heavy-Duty Post Mount Fitting</b> <ul style="list-style-type: none"> <li>• For use with glass up to 27mm</li> <li>• Complete with hardware to mount to post or column</li> <li>• This single arm fitting is used to attach a single glass panel to a structural end post</li> <li>• Comes with a 16 x 99.5mm stainless steel threaded stud and three matching nuts with washers</li> </ul>                             |
|                                                                                     | <b>PMH1PS</b><br>Polished Stainless          |                                                                                                                                                                                                                                                                                                                                                                                                                                          |
|  | <b>PMH1LBS</b><br>Brushed Stainless          | <b>CRL Single Long Arm Heavy-Duty Post Mount Fitting</b> <ul style="list-style-type: none"> <li>• For use with glass up to 27mm</li> <li>• Complete with hardware to mount to post or column</li> <li>• This long arm fitting is used to attach a single glass panel to structural end post and match over "V" fitting arms</li> <li>• Comes with 16 x 99.5mm stainless steel threaded stud and matching nuts with washers.</li> </ul>   |
|                                                                                     | <b>PMH1LPS</b><br>Polished Stainless         |                                                                                                                                                                                                                                                                                                                                                                                                                                          |

# CRL Heavy Duty Spider Fittings

## CODE

## DESCRIPTION



**PMH2BS**  
Brushed Stainless

**PMH2PS**  
Polished Stainless

### CRL Double Arm Heavy-Duty Post Mount Fitting

- For use with glass up to 27mm
- Complete with hardware to mount to post or column
- This double arm fitting is used to attach two inline glass panels to a structural centre post
- Comes with 16 x 99.5mm stainless steel threaded stud and three matching nuts with washers



**PMH2VBS**  
Brushed Stainless

**PMH2VPS**  
Polished Stainless

### CRL Double Arm "V" Heavy-Duty Post Mount Fitting

- For use with glass up to 27mm
- Complete with hardware to mount to post or column
- This post mount fitting is used to attach a single glass panel to a structural end post, or two inline glass panels to a structural centre post
- Comes with 16 x 99.5mm stainless steel threaded stud and three matching nuts with washers



**PMH3BS**  
Brushed Stainless

**PMH3PS**  
Polished Stainless

### CRL Three Arm Heavy-Duty Post Mount Fitting

- For use with glass up to 27mm
- Complete with hardware to mount to post or column
- This three arm fitting is used to attach three inline glass panels to a structural centre post where they abut to a soffit corner
- Comes with 16 x 99.5mm stainless steel threaded stud and three matching nuts with washers



**PMH4BS**  
Brushed Stainless

**PMH4PS**  
Polished Stainless

### CRL Four Arm Heavy-Duty Post Mount Fitting

- For use with glass up to 27mm
- Complete with hardware to mount to post or column
- This four arm fitting is used to attach two inline glass panels to a structural centre post.
- Comes with 16 x 99.5mm stainless steel threaded stud and three matching nuts with washers



**PMH2V90BS**  
Brushed Stainless

**PMH2V90PS**  
Polished Stainless

### CRL Double Arm "V" 90 Degree Heavy-Duty Post Mount Fitting

- For use with glass up to 27mm
- Complete with hardware to mount to post or column
- This double arm fitting is used to attach two 90 degree glass panels at the top or bottom of a structural corner post
- Comes with 16 x 99.5mm stainless steel threaded stud and three matching nuts with washers



**PMH490BS**  
Brushed Stainless

**PMH490PS**  
Polished Stainless

### CRL 4-Way Arm 90 Degree Heavy-Duty Post Mount Fitting

- For use with glass up to 27mm
- Complete with hardware to mount to post or column
- This four arm fitting is used to attach two 90 degree glass panels in the middle to a structural corner post
- Comes with 16 x 99.5mm stainless steel threaded stud and three matching nuts with washers

# CRL Heavy Duty Spider Fittings

## CODE

## DESCRIPTION



**FMH1BS**  
Brushed Stainless

**FMH1PS**  
Polished Stainless

### CRL Single Arm Heavy-Duty Wall/Fin Mount Fitting

- For use with glass up to 27mm
- Complete with hardware to mount to wall or structural fin
- This fitting is used to attach a single glass panel to a wall or structural fin
- Comes with two 10 x 59mm stainless steel threaded studs and two matching cap nuts with washers



**FMH2BS**  
Brushed Stainless

**FMH2PS**  
Polished Stainless

### CRL Double Arm Heavy-Duty Wall/Fin Mount Fitting

- For use with glass up to 27mm
- Complete with hardware to mount to wall or structural fin
- Use this double arm fitting to attach two inline glass panels to a structural fin
- Comes with two 10 x 59mm stainless steel threaded studs and two matching cap nuts with washers



**FMH1LHBS**  
Brushed Stainless

**FMH1LHPS**  
Polished Stainless

### CRL L.H. Single Arm Heavy-Duty Wall/Fin Mount Fitting

- For use with glass up to 27mm
- Complete with hardware to mount to wall or structural fin
- This Fitting is used to attach a single glass panel to a wall or structural glass fin
- Comes with two 10 x 59mm stainless steel threaded studs and two matching cap nuts with washers



**FMH1RHBS**  
Brushed Stainless

**FMH1RHPS**  
Polished Stainless

### CRL R.H. Single Arm Heavy-Duty Wall/Fin Mount Fitting

- For use with glass up to 27mm
- Complete with hardware to mount to wall or structural fin
- This fitting is used to attach a single glass panel to a wall or structural glass fin.
- Comes with two 10 x 59mm stainless steel threaded studs and two matching cap nuts with washers



**FMH2VBS**  
Brushed Stainless

**FMH2VPS**  
Polished Stainless

### CRL Double Arm "V" Heavy-Duty Wall/Fin Mount Fitting

- For use with glass up to 27mm
- Complete with hardware to mount to wall or structural fin
- This fitting is used to attach a single glass panel to a wall or structural glass fin.
- Comes with two 10 x 59mm stainless steel threaded studs and two matching cap nuts with washers







**FMH4BS**  
Brushed Stainless

**FMH4PS**  
Polished Stainless

### CRL Four Arm "V" Heavy-Duty Wall/Fin Mount Fitting

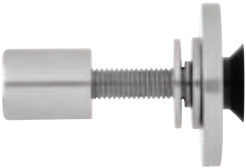
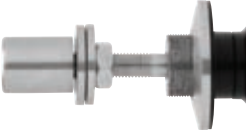
- For use with glass up to 27mm
- Complete with hardware to mount to wall or structural fin
- Use this four arm fitting to attach two inline glass panels to a structural centre fin
- Comes with two 10 x 59mm stainless steel threaded studs and two matching cap nuts with washers

# CRL Regular Spider Fittings

|                                                                                     | CODE                                                 | DESCRIPTION                                                                                                                                                                                                                                                                                                                                                                                                                              |
|-------------------------------------------------------------------------------------|------------------------------------------------------|------------------------------------------------------------------------------------------------------------------------------------------------------------------------------------------------------------------------------------------------------------------------------------------------------------------------------------------------------------------------------------------------------------------------------------------|
|    | <b>RRF10BS</b><br>Brushed Stainless                  | <b>CRL Rigid Head Combination Glass Attachment</b> <ul style="list-style-type: none"> <li>• For use with 10 to 12mm toughened glass</li> <li>• The rigid head attachments allow for a secure attachment and minimize the deflection of the glass panels</li> <li>• Typically used only for interior applications</li> <li>• 'Flush' or 'cap' mount</li> </ul>                                                                            |
|                                                                                     | <b>RRF10PS</b><br>Polished Stainless                 |                                                                                                                                                                                                                                                                                                                                                                                                                                          |
|    | <b>RSF10BS</b><br>Brushed Stainless                  | <b>CRL Swivel Head Combination Glass Attachment</b> <ul style="list-style-type: none"> <li>• For use with 10 to 12mm toughened glass</li> <li>• The head of the swivel glass attachment can tilt up to 6 degrees in any direction on its ball and socket joint minimising stress applied to the glass</li> <li>• Typically used in conditions where the glass will be subject to live loads</li> <li>• 'Flush' or 'cap' mount</li> </ul> |
|                                                                                     | <b>RSF10PS</b><br>Polished Stainless                 |                                                                                                                                                                                                                                                                                                                                                                                                                                          |
|   | <b>RRF10RW</b><br>Rigid Glass Attachment             | <b>CRL Replacement Gasket Set</b> <ul style="list-style-type: none"> <li>• Replace worn or lost gaskets for Cat. No. RRF10BS and RRF10PS</li> </ul>                                                                                                                                                                                                                                                                                      |
|                                                                                     | <b>RSF10RW</b><br>Swivel Glass Attachment            |                                                                                                                                                                                                                                                                                                                                                                                                                                          |
|  | <b>M16SET</b><br>Post Mounted<br>Stainless Steel     | <b>CRL Replacement Stud Set</b> <ul style="list-style-type: none"> <li>• For mounting spider fittings to posts</li> <li>• Stud set for fin mounted spider fittings</li> <li>• Two finishes available</li> </ul>                                                                                                                                                                                                                          |
|                                                                                     | <b>M10SETBS</b><br>Fin Mounted<br>Brushed Stainless  |                                                                                                                                                                                                                                                                                                                                                                                                                                          |
|                                                                                     | <b>M10SETPS</b><br>Fin Mounted<br>Polished Stainless |                                                                                                                                                                                                                                                                                                                                                                                                                                          |
|  | <b>PMR1BS</b><br>Brushed Stainless                   | <b>CRL Single Arm Regular Duty Post Mount Fitting</b> <ul style="list-style-type: none"> <li>• For use with glass up to 12mm</li> <li>• Complete with hardware to mount to post or column</li> <li>• This single arm fitting is used to attach a single glass panel to a structural end post</li> <li>• Comes with a 16 x 99.5mm stainless steel threaded stud and three matching nuts with washers</li> </ul>                           |
|                                                                                     | <b>PMR1PS</b><br>Polished Stainless                  |                                                                                                                                                                                                                                                                                                                                                                                                                                          |
|   | <b>PMR1LBS</b><br>Brushed Stainless                  | <b>CRL Single Long Arm Regular Post Mount Fitting</b> <ul style="list-style-type: none"> <li>• For use with glass up to 12mm</li> <li>• Complete with hardware to mount to post or column</li> <li>• This long arm fitting is used to attach a single glass panel to structural end post and match over "V" fitting arms</li> <li>• Comes with 16 x 99.5mm stainless steel threaded stud and matching nuts with washers.</li> </ul>      |
|                                                                                     | <b>PMR1LPS</b><br>Polished Stainless                 |                                                                                                                                                                                                                                                                                                                                                                                                                                          |



# CRL Regular Spider Fittings

## CODE

## DESCRIPTION



**PMR2BS**  
Brushed Stainless

**PMR2PS**  
Polished Stainless

### CRL Double Arm Heavy-Duty Post Mount Fitting

- For use with glass up to 12mm
- Complete with hardware to mount to post or column
- This double arm fitting is used to attach two inline glass panels to a structural centre post
- Comes with 16 x 99.5mm stainless steel threaded stud and three matching nuts with washers



**PMR2VBS**  
Brushed Stainless

**PMR2VPS**  
Polished Stainless

### CRL Double Arm "V" Heavy-Duty Post Mount Fitting

- For use with glass up to 12mm
- Complete with hardware to mount to post or column
- This post mount fitting is used to attach a single glass panel to a structural end post, or two inline glass panels to a structural centre post
- Comes with 16 x 99.5mm stainless steel threaded stud and three matching nuts with washers



**PMR3BS**  
Brushed Stainless

**PMR3PS**  
Polished Stainless

### CRL Three Arm Regular Duty Post Mount Fitting

- For use with glass up to 12mm
- Complete with hardware to mount to post or column
- This three arm fitting is used to attach three inline glass panels to a structural centre post where they abut to an opening
- Comes with 16 x 99.5mm stainless steel threaded stud and three matching nuts with washers



**PMR4BS**  
Brushed Stainless

**PMR4PS**  
Polished Stainless

### CRL Four Arm Regular Duty Post Mount Fitting

- For use with glass up to 12mm
- Complete with hardware to mount to post or column
- This four arm fitting is used to attach two inline glass panels to a structural centre post.
- Comes with 16 x 99.5mm stainless steel threaded stud and three matching nuts with washers



**PMR2V90BS**  
Brushed Stainless

**PMR2V90PS**  
Polished Stainless

### CRL Double Arm "V" 90 Degree Regular Duty Post Mount Fitting

- For use with glass up to 12mm
- Complete with hardware to mount to post or column
- This double arm fitting is used to attach two 90 degree glass panels at the top or bottom of a structural corner post
- Comes with 16 x 99.5mm stainless steel threaded stud and three matching nuts with washers



**PMR490BS**  
Brushed Stainless

**PMR490PS**  
Polished Stainless

### CRL Four Arm 90 Degree Regular Duty Post Mount Fitting

- For use with glass up to 12mm
- Complete with hardware to mount to post or column
- This four arm fitting is used to attach two 90 degree glass panels in the middle to a structural corner post
- Comes with 16 x 99.5mm stainless steel threaded stud and three matching nuts with washers

# CRL Regular Spider Fittings

## CODE

## DESCRIPTION



**FMR1BS**  
Brushed Stainless

**FMR1PS**  
Polished Stainless

### CRL Single Arm Regular Duty Wall/Fin Mount Fitting

- For use with glass up to 12mm
- Complete with hardware to mount to wall or structural fin
- This Fitting is used to attach a single glass panel to a wall or structural fin
- Comes with two M10-1.5 x 59mm stainless steel threaded studs and two matching cap nuts with washers



**FMR2BS**  
Brushed Stainless

**FMR2PS**  
Polished Stainless

### CRL Double Arm Regular Duty Wall/Fin Mount Fitting

- For use with glass up to 12mm
- Complete with hardware to mount to post or column
- This single arm fitting is used to attach a single glass panel to a structural end post
- Comes with two M10-1.5 x 59mm stainless steel threaded stud and two matching nuts with washers



**FMR1LHBS**  
Brushed Stainless

**FMR1LHPS**  
Polished Stainless

### CRL L.H. Single Arm Regular Duty Wall/Fin Mount Fitting

- For use with glass up to 12mm
- Complete with hardware to mount to post or column
- This fitting is used to attach a single glass panel to a wall or structural glass fin
- Comes with two 10mm x 59mm stainless steel threaded studs and two matching cap nuts with washers



**FMR1RHBS**  
Brushed Stainless

**FMR1RHPS**  
Polished Stainless

### CRL R.H. Single Arm Regular Duty Wall/Fin Mount Fitting

- For use with glass up to 12mm
- Complete with hardware to mount to post or column
- This fitting is used to attach a single glass panel to a wall or structural glass fin
- Comes with two 10mm x 59mm stainless steel threaded studs and two matching cap nuts with washers



**FMR2VBS**  
Brushed Stainless

**FMR2VPS**  
Polished Stainless

### CRL Double Arm "V" Regular Duty Wall/Fin Mount Fitting

- For use with glass up to 12mm
- Complete with hardware to mount to post or column
- This fitting is used to attach a single glass panel to a wall or structural fin
- Comes with two 10mm x 59mm stainless steel threaded studs and two matching cap nuts with washers



**FMR4BS**  
Brushed Stainless

**FMR4PS**  
Polished Stainless

### CRL Four Arm "V" Regular Duty Wall/Fin Mount Fitting

- For use with glass up to 12mm
- Complete with hardware to mount to post or column
- Use this four arm fitting to attach two inline glass panels to a structural centre fin
- Comes with two 10mm x 59mm stainless steel threaded studs and two matching cap nuts with washers

|                                                                                     | CODE                                                           | DESCRIPTION                                                                                                                                                                                                                                                                                                                                                                              |
|-------------------------------------------------------------------------------------|----------------------------------------------------------------|------------------------------------------------------------------------------------------------------------------------------------------------------------------------------------------------------------------------------------------------------------------------------------------------------------------------------------------------------------------------------------------|
|    | <b>FTF12BS</b><br>Brushed Stainless<br>305mm                   | <b>CRL Fin Top/Bottom Shoe Fittings for 19mm Glass</b> <ul style="list-style-type: none"> <li>• Fin Top/Bottom Shoe Fittings are used to connect the glass fins to the structure of the floor or ceiling</li> <li>• Available in fin sizes 305, 406, 508, 610mm, please see <a href="http://crlaurence.co.uk">crlaurence.co.uk</a> for more details</li> </ul>                           |
|                                                                                     | <b>FTF12PS</b><br>Polished Stainless<br>305mm                  |                                                                                                                                                                                                                                                                                                                                                                                          |
|    | <b>FSF12BS</b><br>Brushed Stainless<br>305mm                   | <b>CRL Fin Splice Fittings for 19mm Glass</b> <ul style="list-style-type: none"> <li>• Fin Splice Fittings are used to stack multiple pieces of glass to construct extra tall fins used to stabilize the glass facade</li> <li>• Available in fin sizes 305, 406, 508, 610mm, please see <a href="http://crlaurence.co.uk">crlaurence.co.uk</a> for more details</li> </ul>              |
|                                                                                     | <b>FSF12PS</b><br>Polished Stainless<br>305mm                  |                                                                                                                                                                                                                                                                                                                                                                                          |
|   | <b>FSU12BS</b><br>Brushed Stainless<br>Fin size: 305 to 508mm  | <b>CRL Fin Suspension Fittings</b> <ul style="list-style-type: none"> <li>• Fin suspension fittings are used to hang the glass fins from the structure of the ceiling by the fin top/bottom shoe fittings</li> <li>• No glass fabrication required</li> <li>• 610 fin size also available, please see <a href="http://crlaurence.co.uk">crlaurence.co.uk</a> for more details</li> </ul> |
|                                                                                     | <b>FSU12PS</b><br>Polished Stainless<br>Fin size: 305 to 508mm |                                                                                                                                                                                                                                                                                                                                                                                          |
|  | <b>AMS0B112CBS</b><br>Brushed Stainless<br>Regular Duty        | <b>CRL Spider Fitting Post Adapters (Custom Length)</b> <ul style="list-style-type: none"> <li>• Available for round or flat posts</li> <li>• Custom length to your specifications</li> <li>• Regular duty 38mm diameter</li> <li>• Heavy duty 51mm diameter, please see <a href="http://crlaurence.co.uk">crlaurence.co.uk</a> for more details</li> </ul>                              |
|                                                                                     | <b>AMS0B112CPS</b><br>Polished Stainless<br>Regular Duty       |                                                                                                                                                                                                                                                                                                                                                                                          |
|  | <b>CBP90BS</b><br>Brushed Stainless                            | <b>CRL 90 Degree Corner Bracket</b> <ul style="list-style-type: none"> <li>• Used to secure glass at 90 degree corners</li> <li>• Supplied with four rigid countersunk glass connecting screws</li> </ul>                                                                                                                                                                                |
|                                                                                     | <b>CBP90PS</b><br>Polished Stainless                           |                                                                                                                                                                                                                                                                                                                                                                                          |
|  | <b>CBP135BS</b><br>Brushed Stainless                           | <b>CRL 135 Degree Corner Bracket</b> <ul style="list-style-type: none"> <li>• Used to secure glass at 135 degree corners</li> <li>• Supplied with four rigid countersunk glass connecting screws</li> </ul>                                                                                                                                                                              |
|                                                                                     | <b>CBP135PS</b><br>Brushed Stainless                           |                                                                                                                                                                                                                                                                                                                                                                                          |

## CODE

## DESCRIPTION



**CCB2BS**  
Brushed Stainless

**CCB2PS**  
Polished Stainless

### CRL 2-Way Glass / 1-Way Wall Circular Bracket

- Used to link two inline panels of glass to a fin support behind
- Used to connect one or two inline panels to a fin support, or when split apart they can be used to connect one panel to a wall
- Supplied with two rigid countersunk glass connecting screws and one fin securing bolt



**CCB4BS**  
Brushed Stainless

**CCB4PS**  
Polished Stainless

### CRL 4-Way Glass / 2-Way Wall Circular Bracket

- Used to link two or four inline panels of glass to a fin support behind
- Used to connect two or four inline panels to a fin support, or when split apart they can be used to connect one or two panels to a wall
- Supplied with four rigid countersunk glass connecting screws and two fin securing bolt



**CLB1BS**  
Brushed Stainless

**CLB1PS**  
Polished Stainless

### CRL Link Bracket

- Used to connect two 12mm inline glass panels together to reduce differential deflection
- Supplied with two glass connecting screws



**M8SBSS**  
Brushed Stainless

### CRL Stainless Steel Sex Bolt

- Stainless Steel Sex Bolts are countersunk for use with Cat. No. FTF12, FTF16, FTF20, FTF24, FSF12, FSF16, FSF20, FSF24, and CLB1 fittings and brackets



**WKSP1HD**

### CRL Adjustable Wrench for Heavy-Duty Spider Fittings

- Fully adjustable with multiple size pins to fit a wide variety of sizes
- Makes installation of Spider fittings easier
- Fits CRL brand heavy-duty Spider fittings

|                                                                                     | CODE     | DESCRIPTION                                                                                                                                                                                                                                                                                                                                                   |
|-------------------------------------------------------------------------------------|----------|---------------------------------------------------------------------------------------------------------------------------------------------------------------------------------------------------------------------------------------------------------------------------------------------------------------------------------------------------------------|
|    | EURTV408 | <b>CRL Neutral Cure Silicone Sealant</b> <ul style="list-style-type: none"> <li>• Available in clear, black and white</li> </ul>                                                                                                                                                                                                                              |
|    | EU33S    | <b>CRL Acetic Cure Silicone Sealant</b> <ul style="list-style-type: none"> <li>• Available in clear, black and white</li> </ul>                                                                                                                                                                                                                               |
|   | 95C      | <b>CRL 95C Silicone Building Sealant</b> <ul style="list-style-type: none"> <li>• Excellent primerless adhesion to most common construction substrates</li> <li>• ±50% joint width movement</li> <li>• AAMA approved</li> <li>• Long tooling time, all temperature gunning</li> <li>• Available in six colours</li> <li>• 20 year limited warranty</li> </ul> |
|  | SSG4000  | <b>CRL Black GE® UltraGlaze® Silicone Structural Glazing Sealant</b> <ul style="list-style-type: none"> <li>• High-strength neutral cure sealant for use in structural glazing</li> <li>• Primerless adhesion to most substrates</li> </ul>                                                                                                                   |

## Want more?

Look out for our quarterly Glass Showcase - packed full of deals and new products.



Order yours from [crlaurence.co.uk](http://crlaurence.co.uk)



|                                                                                               | CODE   | DESCRIPTION                                                                                                                                                                                                                                                                                                                                                                                                                                                                                                   |
|-----------------------------------------------------------------------------------------------|--------|---------------------------------------------------------------------------------------------------------------------------------------------------------------------------------------------------------------------------------------------------------------------------------------------------------------------------------------------------------------------------------------------------------------------------------------------------------------------------------------------------------------|
|  <p>CE</p>   | S338   | <p><b>CRL Sure-Grip 203mm Vacuum Lifter</b></p> <ul style="list-style-type: none"> <li>• Greatest lifting capacity of any 203mm pump-activated vacuum lifter</li> <li>• One hand pump and attachment for safety when needed</li> <li>• Built-in vacuum loss indicator</li> <li>• Soft contoured sure-grip handle for comfort</li> <li>• Meets CE conformance with 3.3x safety factor rating</li> <li>• Moulded carrying case</li> <li>• 65kg lifting capacity</li> </ul>                                      |
|  <p>CE</p>   | S108   | <p><b>CRL 203mm Pump-Action Vacuum Lifter</b></p> <ul style="list-style-type: none"> <li>• 203mm diameter pad</li> <li>• Proven reliability throughout the world</li> <li>• Heavy-duty 5mm thick ABS handle resists bending, especially during heavy lifts</li> <li>• Fast, safe attachment to smooth, non-porous flat surfaces</li> <li>• Four extra mounting points make it easy to attach to metal lifting frames, jigs, and our vacuum ratchet tensioning kit</li> <li>• 56kg lifting capacity</li> </ul> |
|  <p>CE</p>  | 05062P | <p><b>CRL Double Pad Suction Lifter</b></p> <ul style="list-style-type: none"> <li>• Two individually operated pads</li> <li>• Lightweight plastic design</li> <li>• 60kg lifting capacity</li> </ul>                                                                                                                                                                                                                                                                                                         |
|  <p>CE</p> | 05062  | <p><b>CRL Aluminium Double Pad Vacuum Lifter</b></p> <ul style="list-style-type: none"> <li>• Four models to choose from</li> <li>• Handle design allows easy manoeuvring</li> <li>• Strong, lightweight aluminium</li> </ul>                                                                                                                                                                                                                                                                                 |
|            | PSB040 | <p><b>CRL Clear Plastic Setting Blocks</b></p> <ul style="list-style-type: none"> <li>• Barely visible blocks are great for use in mirror and frameless shower installations</li> <li>• 80±5 durometer hardness</li> <li>• 1mm thick, 6.3mm wide, 51mm long</li> </ul>                                                                                                                                                                                                                                        |

Call FREE on 00 800 0421 6144  
Fax FREE on 00 800 0262 3299



**Manchester**

Charles Babbage Avenue  
Kingsway Business Park,  
Rochdale, OL16 4NW, England  
Tel: +44 (0) 1706 863 600  
Fax: +44 (0) 1706 869 860  
[www.crlaurence.co.uk](http://www.crlaurence.co.uk)



**Stuttgart**

Boschstrasse 7  
D-74360 Ilsfeld  
Germany  
Tel: +49 (0) 7062 915 93 15  
Fax: +49 (0) 7062 915 93 16  
[www.crlaurence.de](http://www.crlaurence.de)



**Copenhagen**

Stamholmen 70 Unit B,  
DK-2650 Hvidovre  
Denmark  
Tel: +45 36 72 09 00  
Fax: +45 36 70 33 35  
[www.crlaurence.dk](http://www.crlaurence.dk)



**France**

Boschstrasse 7  
D-74360 Ilsfeld  
Germany  
Tel: +49 (0) 7062 915 93 15  
Fax: +49 (0) 7062 915 93 16  
[www.crlaurence.fr](http://www.crlaurence.fr)



View Our Full Range of  
Architectural Railing Systems...

Our EUHR11 Architectural Balustrade and Railing  
Systems Catalogue

- Glass Railings/Balustrades
- TAPER-LOC® Railing System
- Swinging Gate Systems
- Post Railing Systems
- Welded Railing Systems
- Hand Railing Systems
- Aluminium Railing Systems
- Glass Walls/Windcreens
- Tools/Accessories

You may also be interested in...

EUAH11 Architectural Hardware  
'All Glass' Entrance Systems Catalogue

- Architectural Metals
- Door and Sidelite Rails
- Door Closers
- Centre Locks
- Glass Clamps
- Headers and Channels
- Ladder Pulls
- Locking Hardware
- Door Closers and Hinges
- Patch Hardware
- Pivot Door Systems
- Push/Pull Handles
- Sliding and Stacking Glass Door Systems
- Spider Fittings
- Standoff Systems

Catalogues are available to download  
or view online at [crlaurence.co.uk](http://crlaurence.co.uk)  
or [crlaurence.de](http://crlaurence.de)

# TAPER-LOC<sup>®</sup>

Install glass with ease...

Frameless Glass Balustrade System





# Install glass with ease

Project: Greenwich Peninsula





**CRL proudly presents the innovative Dry Glaze TAPER-LOC® Glass Balustrade System designed for quick, easy and secure installations.**

- 50% faster to install than traditional alternatives
- For toughened/toughened laminated glass from 12mm-25.52mm thick
- Dry glaze system, no need for cement
- Tested to meet the strictest building code requirements BS6180:1999, BS6399-1:1996 and AbZ
- The product is completely unique because it uses a horizontal TAPER-LOC® design, which allows the system to be adjusted, dismantled and re-set
- Ideal for replacing scratched and broken panels in existing applications

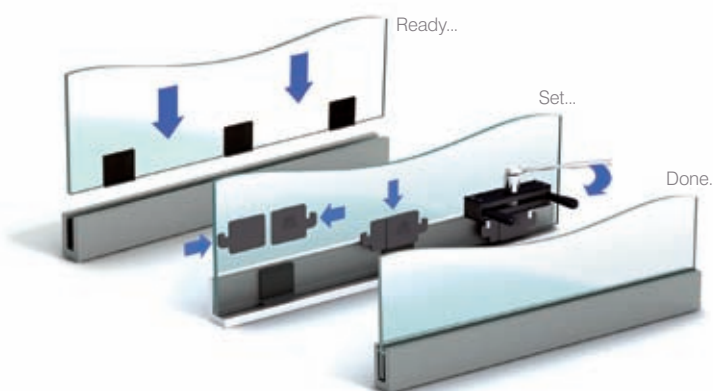

**TAPER-LOC<sup>®</sup>**  
**DRY GLAZE RAILING SYSTEM**



# TAPER-LOC®

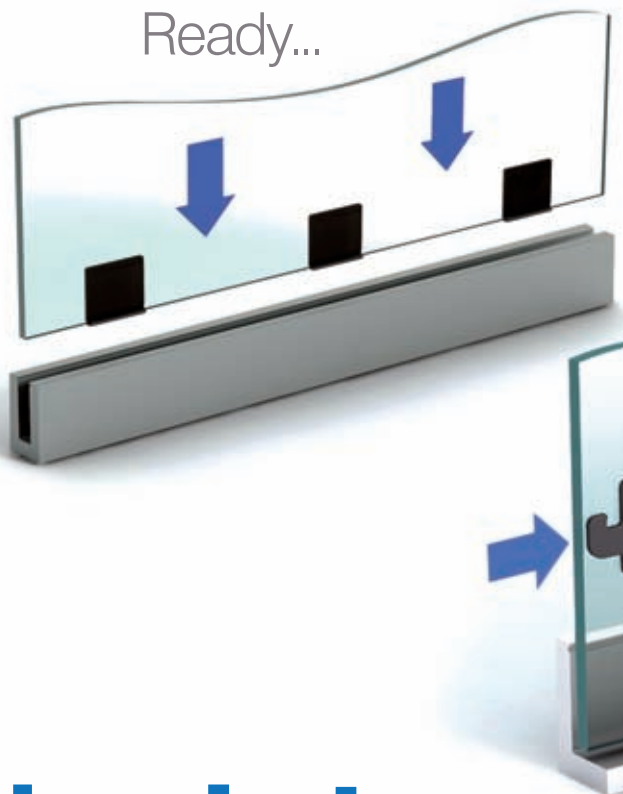

**It's what  
all installers  
have been  
waiting for...**

- Reduces Installation Time by 50%, with no need for wet cement.
- For use with Monolithic and Laminated Toughened Glass
- Easy installation with one compact Installation/Removal Tool
- Designed by CRL for Commercial and Residential Applications

## Easy Installation

The process of installing Glass Balustrades is now easier with CRL's new and innovative TAPER-LOC® system.

TAPER-LOC® has a unique design that lets you apply precision tension to lock it in place, securing the glass in your aluminium base shoe without the use of messy cement. Your installation time is reduced by up to 50% while still exceeding code standards.



### STEP 1

Adhere the L-Setting Blocks to the bottom of the glass panel.

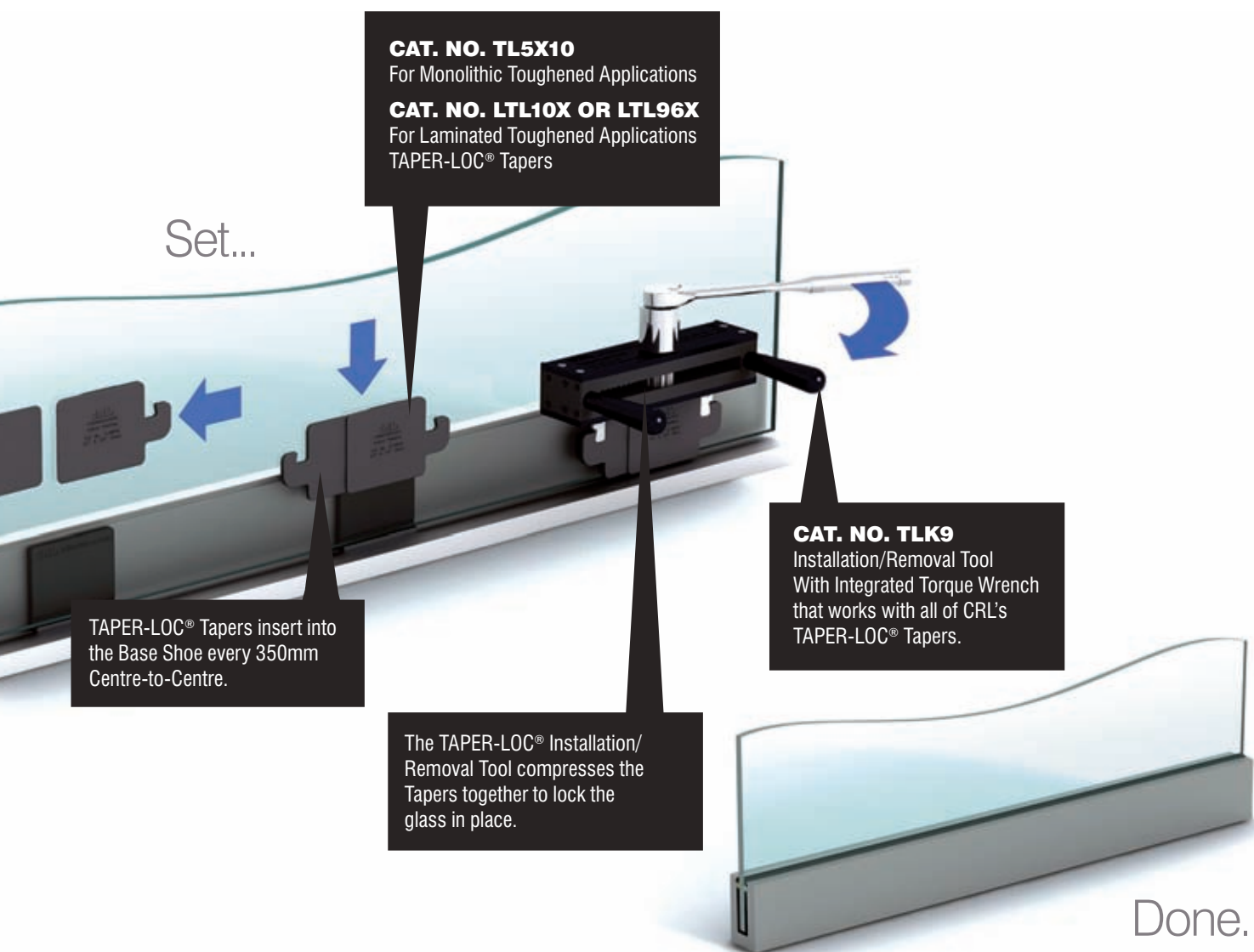

The System includes an Installation/Removal Tool and CRL TAPER-LOC® Tapers for 12mm, 15mm, and 19mm toughened monolithic glass applications, and 13.52mm, 17.52mm, 21.52mm, and 25.52mm laminated toughened glass. Unique because they use a horizontal taper lock design, TAPER-LOC® Tapers are simply installed with CRL's exclusive TLK9 Installation/Removal Tool.

**TAPER-LOC<sup>®</sup>X**  
 DRY GLAZE RAILING SYSTEM



## STEP 2

Insert the Taper set half way down into the Base Shoe as shown, opposite the L-Setting Block, and then squeeze the Tapers together finger tight.



## STEP 3

Place Installation/Removal Tool into position onto the Tapers and push them down into the Base Shoe.





## STEP 4

Crank the Torque Wrench until the wrench clicks and breaks for a few degrees, letting you know the Tapers are locked to the correct measured torque.

# Base Shoes

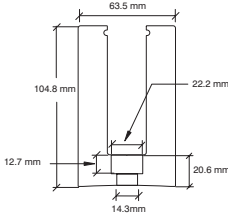
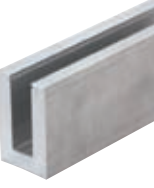
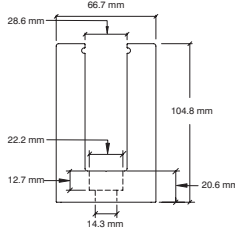
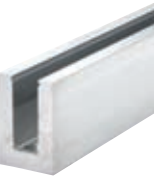
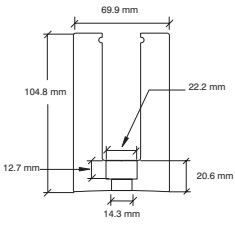
## Monolithic Toughened Glass

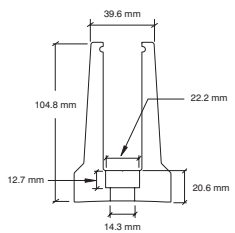
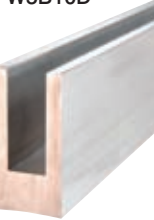
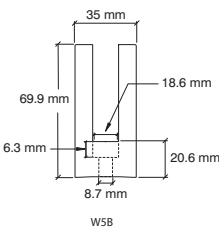
| Base Shoe                                                                                                 | To Suit Glass Thickness | Description                                                                                                                                                                                                                                                                                             | Measurements                                                                                                                                                                                               |
|-----------------------------------------------------------------------------------------------------------|-------------------------|---------------------------------------------------------------------------------------------------------------------------------------------------------------------------------------------------------------------------------------------------------------------------------------------------------|------------------------------------------------------------------------------------------------------------------------------------------------------------------------------------------------------------|
|  <p><b>B5S10D/F</b></p>   | 12mm                    | <p><b>CRL B5S Series Standard Square Base Shoe</b></p> <ul style="list-style-type: none"> <li>• Pre-drilled</li> <li>• Works with TL5X10 TAPER-LOC® Taper Sets</li> </ul>                                                                                                                               |  <p>Stock Length: 3.05m<br/>Hole Size: 14.3mm<br/>Counter Bore: 22mm<br/>Depth: 12.7mm<br/>Centre to Centre: 305mm</p>   |
|  <p><b>B6S10D/F</b></p>  | 15mm                    | <p><b>CRL B6S Series Standard Square Base Shoe</b></p> <ul style="list-style-type: none"> <li>• Pre-drilled</li> <li>• Works with TL5X10 TAPER-LOC® Taper Sets</li> </ul>                                                                                                                               |  <p>Stock Length: 3m<br/>Hole Size: 14.3mm<br/>Counter Bore: 22mm<br/>Depth: 12.7mm<br/>Centre to Centre: 300mm</p>     |
|  <p><b>B7S10D/F</b></p> | 19mm                    | <p><b>CRL BS7 Series Heavy-Duty Square Base Shoe</b></p> <ul style="list-style-type: none"> <li>• Pre-drilled</li> <li>• Works with TL5X10 TAPER-LOC® Taper Sets</li> </ul>                                                                                                                             |  <p>Stock Length: 3.05m<br/>Hole Size: 14.3mm<br/>Counter Bore: 22mm<br/>Depth: 12.7mm<br/>Centre to Centre: 305mm</p> |
|  <p><b>B5T10D</b></p>   | 12 to 16mm              | <p><b>CRL B5T Series Tapered Base Shoe</b></p> <ul style="list-style-type: none"> <li>• Typically used as the Base Channel for Glass Railing Systems requiring a Flush Installation Embedded in Concrete</li> <li>• Works with TL5X10 TAPER-LOC® Taper Sets</li> </ul>                                  |  <p>Stock Length: 3.05m<br/>Hole Size: 14.3mm<br/>Counter Bore: 22mm<br/>Depth: 12.7mm<br/>Centre to Centre: 305mm</p> |
|  <p><b>W5B10D</b></p>   | 10 or 12mm              | <p><b>CRL W5B Series Small Profile Windscreen Base Shoe</b></p> <ul style="list-style-type: none"> <li>• Pre-drilled</li> <li>• Works with TL3W10 TAPER-LOC® Taper Sets</li> <li>• Ideal for Windscreens and Privacy Partitions</li> </ul> <p><b>NOTE: NOT SUITABLE FOR STRUCTURAL APPLICATIONS</b></p> |  <p>Stock Length: 3.05m<br/>Hole Size: 9mm<br/>Counter Bore: 18.6mm<br/>Depth: 6.3mm<br/>Centre to Centre: 305mm</p>   |





Base Shoe codes end with either 'D' or 'F' to determine Surface or Side Mounted.

D = Surface Mounted Base Shoe

F = Side Mounted Base Shoe

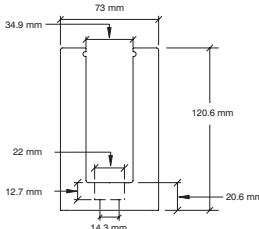
**NOTE:** Undrilled and fascia drilled base shoe available and in stock - contact Technical Sales for details. Minimum order: 1 each. All Base Shoe can be combined for quantity pricing. Must ship common carrier. Stock lengths have a tolerance of plus or minus 19mm.

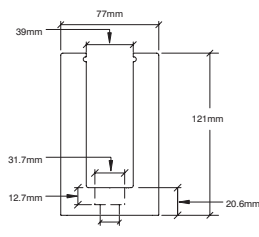
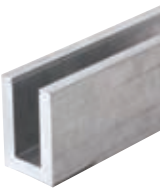
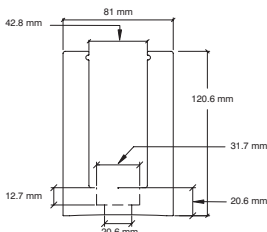
## Laminated Toughened Glass

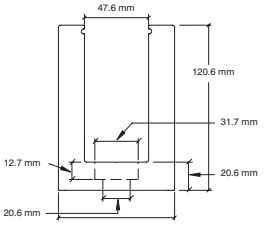
| Base Shoe                                                                                                  | To Suit Glass Thickness | Description                                                                                                                                                                             | Measurements                                                                                                                                                                                              |
|------------------------------------------------------------------------------------------------------------|-------------------------|-----------------------------------------------------------------------------------------------------------------------------------------------------------------------------------------|-----------------------------------------------------------------------------------------------------------------------------------------------------------------------------------------------------------|
|  <p><b>L56S10D/F</b></p>   | 13.52mm                 | <p><b>CRL L56S Series Standard Square Base Shoe</b></p> <ul style="list-style-type: none"> <li>• Pre-drilled</li> <li>• Works with LTL96X TAPER-LOC<sup>®</sup> Taper Sets</li> </ul>   |  <p>Stock Length: 3.05m<br/>Hole Size: 14.3mm<br/>Counter Bore: 22mm<br/>Depth: 12.7mm<br/>Centre to Centre: 305mm</p>  |
|  <p><b>L68S10D/F</b></p>  | 17.52mm                 | <p><b>CRL L68S Series Standard Square Base Shoe</b></p> <ul style="list-style-type: none"> <li>• Pre-drilled</li> <li>• Works with LTL96X TAPER-LOC<sup>®</sup> Taper Sets</li> </ul>   |  <p>Stock Length: 3m<br/>Hole Size: 20mm<br/>Counter Bore: 31.7mm<br/>Depth: 12.7mm<br/>Centre to Centre: 305mm</p>    |
|  <p><b>L21S10D/F</b></p> | 21.52mm                 | <p><b>CRL L21S Series Standard Square Base Shoe</b></p> <ul style="list-style-type: none"> <li>• Pre-drilled</li> <li>• Works with LTL10X TAPER-LOC<sup>®</sup> Taper Sets</li> </ul>   |  <p>Stock Length: 3m<br/>Hole Size: 20.6mm<br/>Counter Bore: 31.7mm<br/>Depth: 12.7mm<br/>Centre to Centre: 300mm</p> |
|  <p><b>L25S10D/F</b></p> | 25.52mm                 | <p><b>CRL L25S Series Heavy-Duty Square Base Shoe</b></p> <ul style="list-style-type: none"> <li>• Pre-drilled</li> <li>• Works with LTL10X TAPER-LOC<sup>®</sup> Taper Sets</li> </ul> |  <p>Stock Length: 3m<br/>Hole Size: 20.6mm<br/>Counter Bore: 31.7mm<br/>Depth: 12.7mm<br/>Centre to Centre: 300mm</p> |

Base Shoe codes end with either 'D' or 'F' to determine Surface or Side Mounted.

D = Surface Mounted Base Shoe

F = Side Mounted Base Shoe

**NOTE:** Undrilled and fascia drilled base shoe available and in stock - contact Technical Sales for details. Minimum order: 1 each. All Base Shoe can be combined for quantity pricing. Must ship common carrier. Stock lengths have a tolerance of plus or minus 19mm.



# Taper Sets



## CRL TAPER-LOC® Taper Set for Monolithic Toughened Glass

CRL's TAPER-LOC® Taper Set for 12 to 19mm glass is made up of two Tapers and one L-Setting Block. Tapers are made of high strength reinforced nylon. They expand in thickness when compressed together with the Cat. No. TLK9 Installation/Removal Tool, mechanically locking the glass panel into the base shoe. Not designed for Laminated Glazing.



| CAT NO.       | Description                                                                                                                 | Application                                            |
|---------------|-----------------------------------------------------------------------------------------------------------------------------|--------------------------------------------------------|
| <b>TL5X10</b> | For 12, 15 and 19mm monolithic toughened glass<br>For use with CRL's B5S, B5A, B5T, B6S and B7S glass balustrade base shoes | Great for glass balustrade and windscreen applications |

**NOTE:** Minimum order: 10 sets.

## CRL TAPER-LOC® Taper Set for Laminated Toughened Glass

Great for stadiums, apartments and shopping centres, or any areas trying to avoid the hazard of broken glass falling to lower levels. CRL's TAPER-LOC® Laminated Taper Set is made up of four Tapers and one L-Setting Block. Tapers are made of high strength reinforced nylon. They expand in thickness when compressed together with the Cat. No. TLK9 Installation/Removal Tool, mechanically locking the glass panel into the base shoe.



| CAT NO.       | Description                                                                                                                               | Application                                                             |
|---------------|-------------------------------------------------------------------------------------------------------------------------------------------|-------------------------------------------------------------------------|
| <b>LTL10X</b> | LTL10X designed for 21.52mm laminated toughened glass (10mm x 1.52mm x 10mm) and 25.52mm laminated toughened glass (12mm x 1.52mm x 12mm) | For use with CRL's laminated toughened glass balustrade base shoes only |
| <b>LTL96X</b> | LTL96X designed for 13.52mm laminated toughened glass (6mm x 1.52mm x 6mm) and 17.52mm laminated toughened glass (8mm x 1.52mm x 8mm)     | For use with CRL's laminated toughened glass balustrade base shoes only |

**NOTE:** Minimum order: 10 sets.

## CRL TAPER-LOC® Taper Set for Monolithic Toughened Glass (Windscreens Only)

CRL's TAPER-LOC® Taper Set for 10mm glass is made up of two Tapers and one L-Setting Block. Tapers are made of high strength reinforced nylon. They expand in thickness when compressed together with the Cat. No. TLK9 Installation/Removal Tool, mechanically locking the glass panel into the base shoe. Not designed for Balustrade Applications or Laminated Glazing.



| CAT NO.       | Description                                                                   | Application                                                                                |
|---------------|-------------------------------------------------------------------------------|--------------------------------------------------------------------------------------------|
| <b>TL3W10</b> | For 10mm monolithic toughened glass<br>914mm recommended maximum glass height | Great for glass windscreen applications<br><b>Not suitable for balustrade applications</b> |

**NOTE:** Minimum order: 10 sets.



## CRL TAPER-LOC<sup>®</sup> Installation / Removal Tool Kit

The Installation/Removal Tool is used for tightening TAPER-LOC<sup>®</sup> Tapers in the channel of the base shoe. The tool has an Integrated Torque Wrench that applies the precise lock-up force necessary to set the glass panels. Simply set in place and turn the wrench until a clicking sound is heard. This assures the Tapers have been locked together. It can also remove Tapers when glass panels need to be reset or replaced.

### KIT CONTENTS:

- 1 x Integrated Torque Wrench
- 1 x Glass Balustrade Setting Tools for Monolithic and Laminated Glass
- 1 x pair of Glass Setting Roller Blocks
- 1 x Standard and Recessed Blades
- 1 x Instructions
- 1 x Moulded Carrying Case



| CAT NO. | Description                                                                                                                                      | Application                                                                                                                           |
|---------|--------------------------------------------------------------------------------------------------------------------------------------------------|---------------------------------------------------------------------------------------------------------------------------------------|
| TLK9    | One tool supports all of CRL's different TAPER-LOC <sup>®</sup> systems<br>Works with monolithic toughened and laminated toughened glazing types | Easily allows you to remove, adjust, or replace glass panels in seconds<br>Complete with a torque wrench designed for precise tension |

NOTE: Minimum order: 1 each.

## CRL PAL Plumb / Angle / Level Indicator

The PAL Plumb/Angle/Level Locator Kit is designed to assist you with level and plumb installations of base shoe for balustrade and windscreen installations. This innovative tool levels the base shoe in both the vertical and horizontal orientations. Perfect for use with all TAPER-LOC<sup>®</sup> installations.



| CAT NO. | Description                                                                                                                                               |
|---------|-----------------------------------------------------------------------------------------------------------------------------------------------------------|
| PAL1K   | Great for levelling the base shoe for balustrade and windscreen applications<br>Features include a digital angle, plumb finder, and level locator display |

NOTE: Minimum order: 1 each.

# Base Shoes

| Glass Thickness:                      | CRL System: | Fixing To Steel:              | Fixing To Concrete:                |
|---------------------------------------|-------------|-------------------------------|------------------------------------|
| <b>Fixed To Steel Base Mounted</b>    |             |                               |                                    |
| 12mm                                  | B5S Series  | M12 S/S Socket Head Cap Screw | M8 x 95mm Hilti Expansion Anchor   |
| 15mm                                  | B6S Series  | M12 S/S Socket Head Cap Screw | M8 x 95mm Hilti Expansion Anchor   |
| 19mm                                  | B7S Series  | M12 S/S Socket Head Cap Screw | M8 x 95mm Hilti Expansion Anchor   |
| 17.52mm                               | L68S Series | M14 S/S Hex Head Screw        | M12 x 156mm Hilti Expansion Anchor |
| 21.52mm                               | L21S Series | M14 S/S Hex Head Screw        | M12 x 156mm Hilti Expansion Anchor |
| 25.52mm                               | L25S Series | M14 S/S Hex Head Screw        | M12 x 156mm Hilti Expansion Anchor |
| <b>Fixed To Concrete Base Mounted</b> |             |                               |                                    |
| 12mm                                  | B5S Series  | M12 S/S Socket Head Cap Screw | M8 x 95mm Hilti Expansion Anchor   |
| 15mm                                  | B6S Series  | M12 S/S Socket Head Cap Screw | M8 x 95mm Hilti Expansion Anchor   |
| 19mm                                  | B7S Series  | M12 S/S Socket Head Cap Screw | M8 x 95mm Hilti Expansion Anchor   |
| 17.52mm                               | L68S Series | M14 S/S Hex Head Screw        | M12 x 156mm Hilti Expansion Anchor |
| 21.52mm                               | L21S Series | M14 S/S Hex Head Screw        | M12 x 156mm Hilti Expansion Anchor |
| 25.52mm                               | L25S Series | M14 S/S Hex Head Screw        | M12 x 156mm Hilti Expansion Anchor |
| <b>Fixed To Steel Side Mounted</b>    |             |                               |                                    |
| 12mm                                  | B5S Series  | M12 S/S Socket Head Cap Screw | M8 x 95mm Hilti Expansion Anchor   |
| 15mm                                  | B6S Series  | M12 S/S Socket Head Cap Screw | M8 x 95mm Hilti Expansion Anchor   |
| 19mm                                  | B7S Series  | M12 S/S Socket Head Cap Screw | M8 x 95mm Hilti Expansion Anchor   |
| 17.52mm                               | L68S Series | M14 S/S Hex Head Screw        | M12 x 156mm Hilti Expansion Anchor |
| 21.52mm                               | L21S Series | M14 S/S Hex Head Screw        | M12 x 156mm Hilti Expansion Anchor |
| 25.52mm                               | L25S Series | M14 S/S Hex Head Screw        | M12 x 156mm Hilti Expansion Anchor |
| <b>Fixed To Concrete Side Mounted</b> |             |                               |                                    |
| 12mm                                  | B5S Series  | M12 S/S Socket Head Cap Screw | M8 x 95mm Hilti Expansion Anchor   |
| 15mm                                  | B6S Series  | M12 S/S Socket Head Cap Screw | M8 x 95mm Hilti Expansion Anchor   |
| 19mm                                  | B7S Series  | M12 S/S Socket Head Cap Screw | M8 x 95mm Hilti Expansion Anchor   |
| 17.52mm                               | L68S Series | M14 S/S Hex Head Screw        | M12 x 156mm Hilti Expansion Anchor |
| 21.52mm                               | L21S Series | M14 S/S Hex Head Screw        | M12 x 156mm Hilti Expansion Anchor |
| 25.52mm                               | L25S Series | M14 S/S Hex Head Screw        | M12 x 156mm Hilti Expansion Anchor |

All the data included within this table is dependant on correct installation of the base shoe plus actual glass strengths.  
Based on 1100mm Balustrade Heights anchored 300mm on center to concrete or steel substrates.

**Typical Installations:**

Residential including stairs and landings but excluding external balconies and edges of roofs

Residential external balconies, edges of roofs, stairs and landings

Residential external balconies, edges of roofs, stairs and landings

Commercial areas susceptible to overcrowding

Commercial areas susceptible to overcrowding

Commercial areas susceptible to overcrowding

Residential including stairs and landings but excluding external balconies and edges of roofs

Residential external balconies, edges of roofs, stairs and landings

Residential external balconies, edges of roofs, stairs and landings

Commercial areas susceptible to overcrowding

Commercial areas susceptible to overcrowding

Commercial areas susceptible to overcrowding

Residential including stairs and landings but excluding external balconies and edges of roofs

Residential external balconies, edges of roofs, stairs and landings

Residential external balconies, edges of roofs, stairs and landings

Commercial areas susceptible to overcrowding

Commercial areas susceptible to overcrowding

Commercial areas susceptible to overcrowding

Residential including stairs and landings but excluding external balconies and edges of roofs

Residential external balconies, edges of roofs, stairs and landings

Residential external balconies, edges of roofs, stairs and landings

Commercial areas susceptible to overcrowding

Commercial areas susceptible to overcrowding

Commercial areas susceptible to overcrowding







**Aluminium Base Shoe for Toughened  
and Laminated Toughened Glass**

- Typically used as the base channel for glass balustrade systems or windscreens
- Drilled and counter bored, or we will custom drill to your specifications
- Custom cladding and end caps

# Typical Installations

## Concrete Substrate Typical Surface Mount Detail

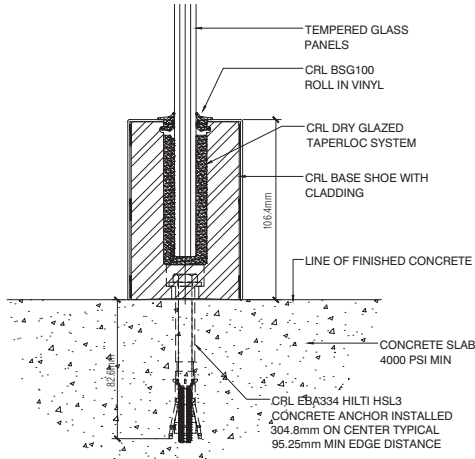

## Concrete Substrate Typical Fascia Mount Detail

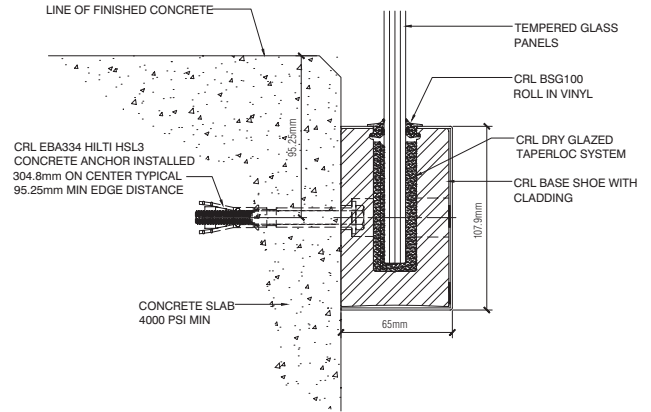

## Steel Tube Substrate Typical Surface Mount Detail

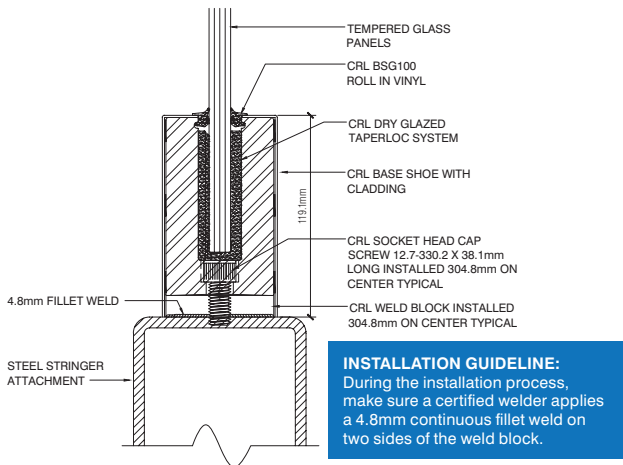

**INSTALLATION GUIDELINE:**  
During the installation process, make sure a certified welder applies a 4.8mm continuous fillet weld on two sides of the weld block.

## Steel Tube Substrate Typical Fascia Mount Detail

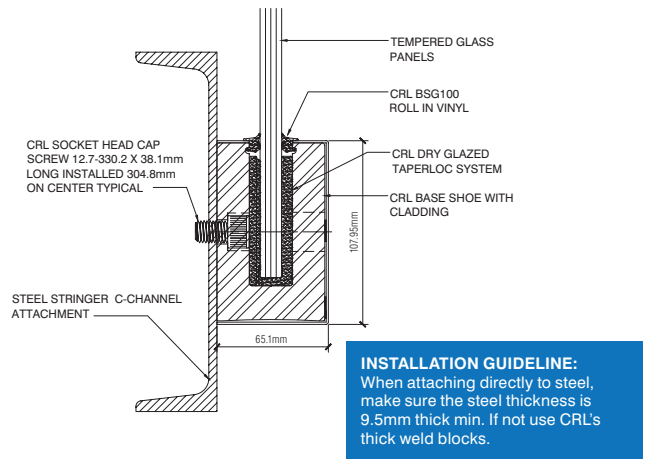

**INSTALLATION GUIDELINE:**  
When attaching directly to steel, make sure the steel thickness is 9.5mm thick min. If not use CRL's thick weld blocks.

## Steel L-Angle Substrate Typical Surface Mount Detail

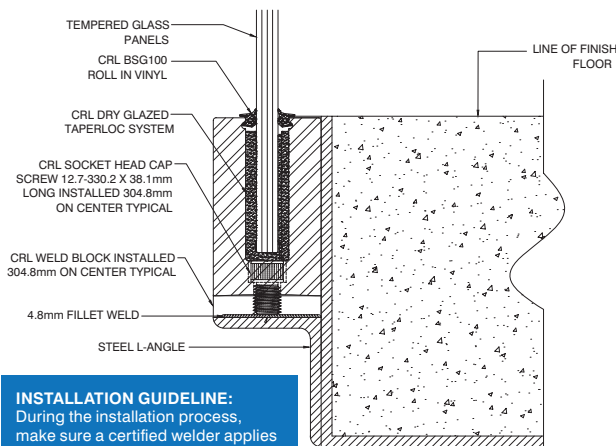

**INSTALLATION GUIDELINE:**  
During the installation process, make sure a certified welder applies a 4.8mm continuous fillet weld on two sides of the weld block.

## Concrete Substrate Typical Concrete Inset Detail

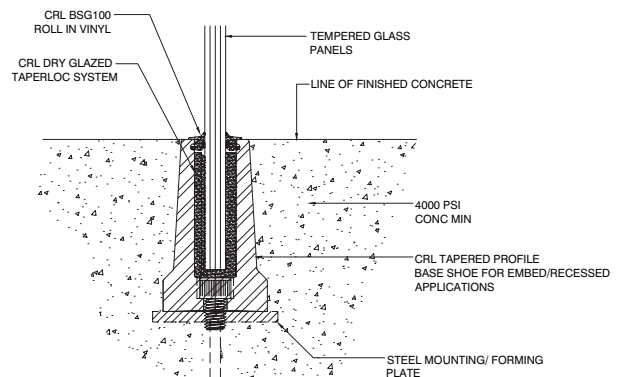

**INSTALLATION GUIDELINE:**  
Anchor spacing will depend on mounting substrate and region of project.



# Cap Rails



Cap Rails are available to suit a huge range of Glass Thicknesses, please call CRL.

## A Selection of Cap Rails available from CRL

- Premium cap rails are manufactured by bump-forming to ensure reduced spring back
- A variety of sizes and finishes available to accommodate monolithic and laminated toughened glass
- A full line of accessories to complete the installation

CRL Balustrade Cap Rails are our latest innovation to set a standard for quality and cutting edge technical resources. We offer a Bump-Formed Cap rail formed around a radius die, ensuring reduced spring back of the finished rail. CRL Premium Cap Rails are fabricated from 16 and 18 gauge material, depending on the diameter. CRL Extruded Aluminium Cap rails have a standard wall thickness of 3.2mm.



CRL Cap Rails are available in diameters ranging from 38.1 to 101.6mm, as well as oval and square profiles in a wide range of architectural finishes. A full line of accessories to complete the installation are also available.

POPULAR ALUMINIUM SHAPES

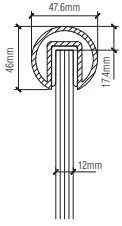

GR19M CAP RAIL  
48.4mm DIA  
FOR 12 TO 16mm GLASS

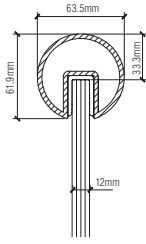

GR25M CAP RAIL  
63.5mm DIA  
FOR 12 TO 16mm GLASS

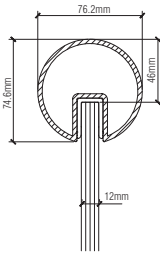

GR30M CAP RAIL  
76.2mm DIA  
FOR 12 TO 16mm GLASS

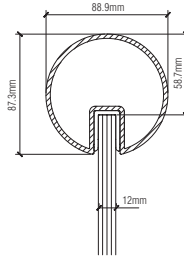

GR35M CAP RAIL  
88.9mm DIA  
FOR 12 TO 16mm GLASS

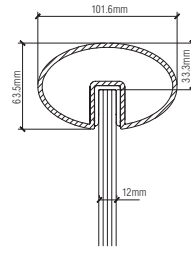

GROV4M CAP RAIL  
101.6 X 63.5mm OVAL  
FOR 12 TO 16mm GLASS

POPULAR WOOD SHAPES

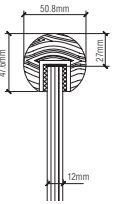

WCR20 CAP RAIL  
50.8mm DIA  
FOR 12 TO 16mm  
GLASS

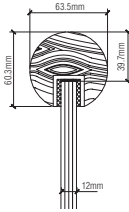

WCR25 CAP RAIL  
63.5mm DIA  
FOR 12 TO 16mm  
GLASS

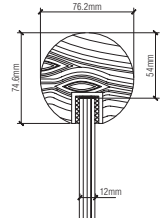

WCR30 CAP RAIL  
76.2mm DIA  
FOR 12 TO 16mm  
GLASS

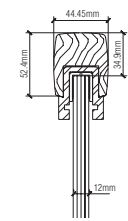

397 CAP RAIL  
54mm x 44.45mm  
FOR 12mm GLASS

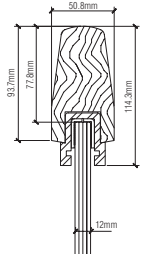

372 CAP RAIL  
76.2mm DIA  
FOR 12mm GLASS

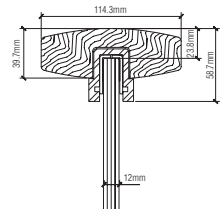

373 CAP RAIL  
41.3 X 114.3mm  
FOR 12mm GLASS

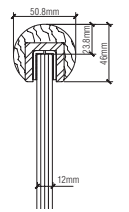

346 CAP RAIL  
50.8mm DIA  
FOR 12mm GLASS

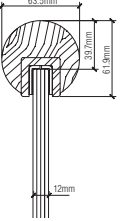

347 CAP RAIL  
63.5mm DIA  
FOR 12mm GLASS

POPULAR STAINLESS STEEL SHAPES

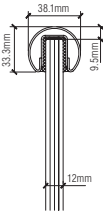

GR15 CAP RAIL  
38.1mm DIA  
FOR 12 TO 16mm GLASS

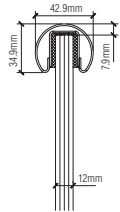

GR16 CAP RAIL  
42.2mm DIA  
FOR 12 TO 5/8" GLASS

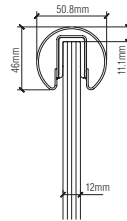

GR20 CAP RAIL  
50.8mm DIA  
FOR 12 TO 16mm GLASS

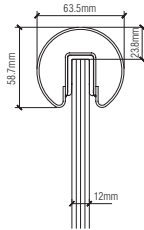

GR25 CAP RAIL  
63.5mm DIA  
FOR 12 TO 16mm GLASS

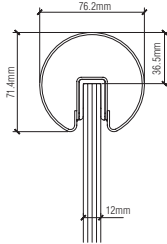

GR30 CAP RAIL  
76.2mm DIA  
FOR 12 TO 16mm GLASS

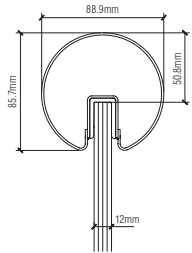

GR35 CAP RAIL  
88.9mm DIA  
FOR 12 TO 16mm GLASS

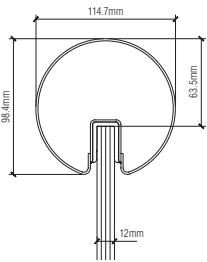

GR40 CAP RAIL  
101.6mm DIA  
FOR 12 TO 16mm GLASS

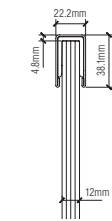

GRUC5 CAP RAIL  
38.1 X 22.2mm PROFILE  
FOR 12 TO 16mm GLASS

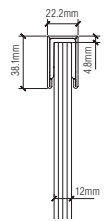

GRUCF5 CAP RAIL  
38.1 X 22.2mm PROFILE  
FOR 12 TO 16mm GLASS

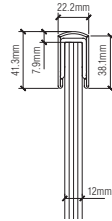

GRUCR5 CAP RAIL  
38.1 X 22.2mm PROFILE  
FOR 12 TO 15.9mm  
GLASS

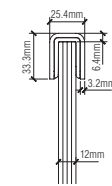

GRL10 CAP RAIL  
33.3 X 25.4mm PROFILE  
FOR 12 TO 16mm GLASS

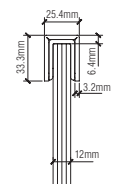

GRLC10 CAP RAIL  
33.3 X 25.4mm PROFILE  
FOR 12 TO 16mm GLASS

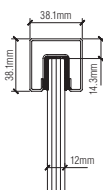

GRS15 CAP RAIL  
38.1mm SQUARE  
PROFILE FOR  
12 TO 16mm GLASS

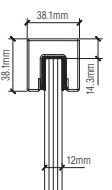

GRSC15 CAP RAIL  
38.1mm SQUARE  
PROFILE FOR  
12 TO 16mm GLASS

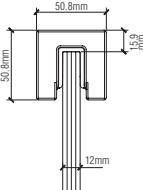

GRSC20 CAP RAIL  
50.8mm SQUARE  
PROFILE FOR  
12 TO 16mm GLASS

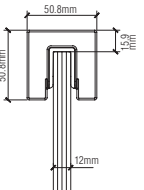

GRS20 CAP RAIL  
50.8mm SQUARE  
PROFILE FOR  
12 TO 16mm GLASS

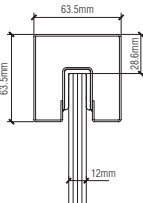

GRS25 CAP RAIL  
63.5mm SQUARE  
PROFILE FOR  
12 TO 16mm GLASS

Call FREE on 00 800 0421 6144

Fax FREE on 00 800 0262 3299



**Manchester**

Charles Babbage Avenue  
Kingsway Business Park,  
Rochdale, OL16 4NW, England  
Tel: +44 (0) 1706 863 600  
Fax: +44 (0) 1706 869 860  
[www.crlaurence.co.uk](http://www.crlaurence.co.uk)



**Stuttgart**

Boschstrasse 7  
D-74360 Ilsfeld  
Germany  
Tel: +49 (0) 7062 915 93 15  
Fax: +49 (0) 7062 915 93 16  
[www.crlaurence.de](http://www.crlaurence.de)



**Copenhagen**

Stamholmen 70 Unit B,  
DK-2650 Hvidovre  
Denmark  
Tel: +45 36 72 09 00  
Fax: +45 36 70 33 35  
[www.crlaurence.dk](http://www.crlaurence.dk)



**Milan**

Via Pregnana 32,  
20010 Cornaredo  
Milano, Italy  
Tel: +39 (0) 2 93562376  
Fax: +39 (0) 2 93566422  
[www.crlaurence.it](http://www.crlaurence.it)

**CRL**<sup>®</sup>  
[crlaurence.co.uk](http://crlaurence.co.uk)



View Our Full Range of  
Architectural Railing Systems...

Our EUHR11 Architectural Balustrade and Railing  
Systems Catalogue

- Glass Railings/Balustrades
- TAPER-LOC<sup>®</sup> Railing System
- Swinging Gate Systems
- Post Railing Systems
- Welded Railing Systems
- Hand Railing Systems
- Aluminium Railing Systems
- Glass Walls/Windcreens
- Tools/Accessories

You may also be interested in...

EUAH11 Architectural Hardware  
'All Glass' Entrance Systems Catalogue

- Architectural Metals
- Door and Sidelite Rails
- Door Closers
- Centre Locks
- Glass Clamps
- Headers and Channels
- Ladder Pulls
- Locking Hardware
- Door Closers and Hinges
- Patch Hardware
- Pivot Door Systems
- Push/Pull Handles
- Sliding and Stacking Glass Door Systems
- Spider Fittings
- Standoff Systems

catalogues are available to download  
or view online at [crlaurence.co.uk](http://crlaurence.co.uk)  
or [crlaurence.de](http://crlaurence.de)



# Glass Awning Support System

Give any entrance an uncomplicated, graceful look, enhancing the design of any building.



# Installation



- High grade 316 stainless steel for durability in even the harshest of environments.
- Complete hardware system for 13.52mm toughened laminated glass awnings
- Provides protection from the weather without obstructing the view
- Adjustable slope for most weather conditions
- All high grade 316 alloy stainless steel components for panel sizes up to 1219mm wide and 1829mm long with two rods and mounting kits
- Easy Installation

The CRL Glass Awning Support System will give any entrance an uncomplicated, graceful look, enhancing the design of any building.

With the use of toughened laminated glass you can add a range of glass colours, textures, and special effects not available with typical monolithic glass. This complements and enhances the design of any building.

The use of eye and fork connections makes the installation of our Awning System quick and easy. The Connecting Rods are designed to make field adjustments on varying job conditions a snap. All components are 316 alloy stainless steel for durability in even the harshest of environments.

## Specifications

**Material:** All 316 alloy stainless steel construction.

**Typical Panel:** 13.52mm thick toughened laminated glass comprised of 6mm toughened glass, 1.52mm interlayer, and 6mm toughened glass.

**Glass Fabrication Required:**

Two 16mm and two 27mm diameter holes per panel.

**Ordering Tip:** Though sold individually, two Connecting Rods and two Mounting Kits are required for each panel.

See [crlaurence.co.uk](http://crlaurence.co.uk) for glass fabrication details

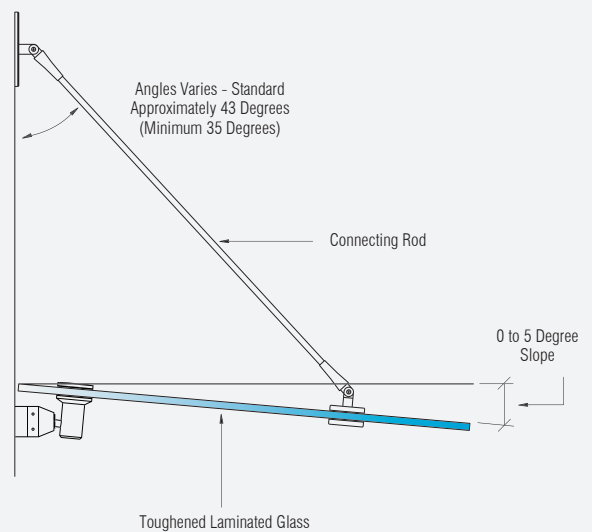

## System Components

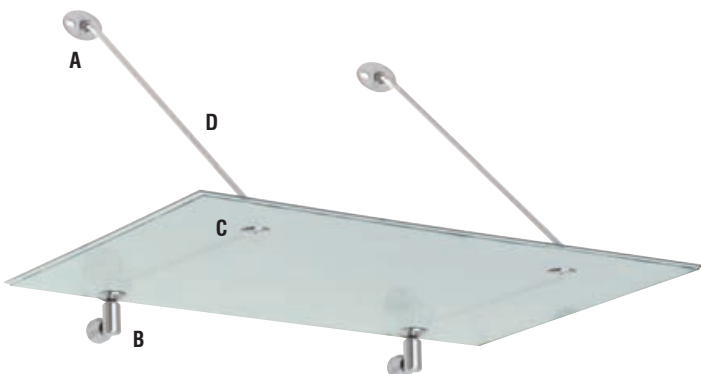

Stainless Steel Mounts (A and B) and Pivots (C) are contained in the GAS190BS Mounting Kit. Order Connecting Rods (D) to suit panel width and application conditions. These are contained in GAS137BS, GAS145BS and GAS154BS.

NOTE: Glass panel not included.



## CRL Mounting Kit

Oval top mounting bracket and pivot for edge of glass furthest from building are connected by one of three available rod lengths.

Bottom Mount and Pivot are connected to each other to support edge of glass nearest the building.



### CODE

GAS190BS

### DESCRIPTION

#### CRL brushed stainless mounting kit

- High grade 316 stainless steel for durability in even the harshest of environments.
- Complete hardware system for 13.52mm toughened laminated glass awnings
- Provides protection from the weather without obstructing the view
- Adjustable slope for most weather conditions
- All high grade 316 alloy stainless steel components for panel sizes up to 1219mm wide and 1829mm long with two rods and mounting kits
- Easy installation allows an economical and elegant solution for both commercial and residential applications

## Connecting Rods

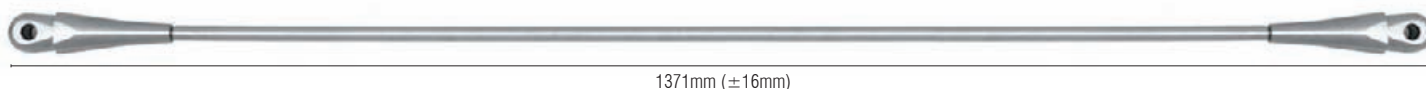
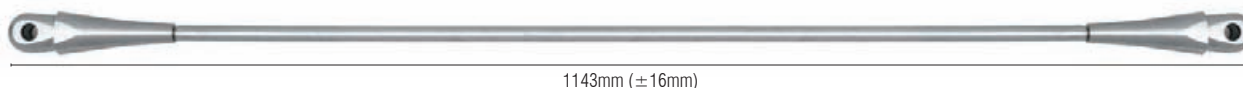
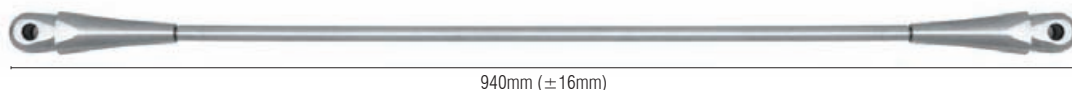

### CODE

GAS137BS

GAS145BS

GAS154BS

### DESCRIPTION

CRL brushed stainless 940mm glass awning system connecting rod for 914mm wide panels

CRL brushed stainless 1143mm glass awning system connecting rod for 1067mm wide panels

CRL brushed stainless 1372mm glass awning system connecting rod for 1219mm wide panels

## CRL Double Plate Glass Awning Pivot

- Fabricated from 316 alloy stainless steel
- Available in brushed or polished stainless

This CRL Double Plate Glass Awning Pivot is for use with our Glass Awning System Support Rods. The Pivot allows for two awning panels to be attached in-line using only one Tension Rod at the connection point instead of two.



### CODE

GAS122BS

### DESCRIPTION

#### CRL brushed stainless double plate glass awning pivot

- Complete hardware system for 13.52mm toughened laminated glass awnings
- Provides protection from the weather without obstructing the view
- Adjustable slope for most weather conditions
- All high grade 316 alloy stainless steel components for panel sizes up to 1219mm wide and 1829mm long with two rods and mounting kits
- Easy installation allows an economical and elegant solution for both commercial and residential applications

# CRL Wall Mounted Brackets



- Used on flat or curved top segmented glass awnings
- Fabricated from 316 alloy stainless steel
- Available in brushed or polished stainless
- Custom angles or 45 degree corner brackets are available on special order
- Requires 13.52mm thick toughened laminated glass

These universal wall mounted glass awning brackets have really become popular, not just for their looks but also their versatility.

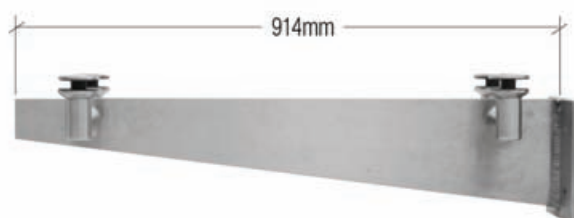
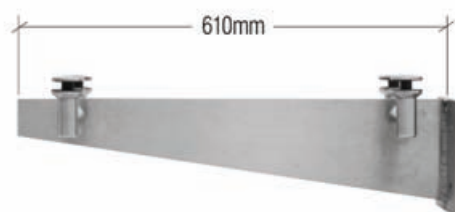
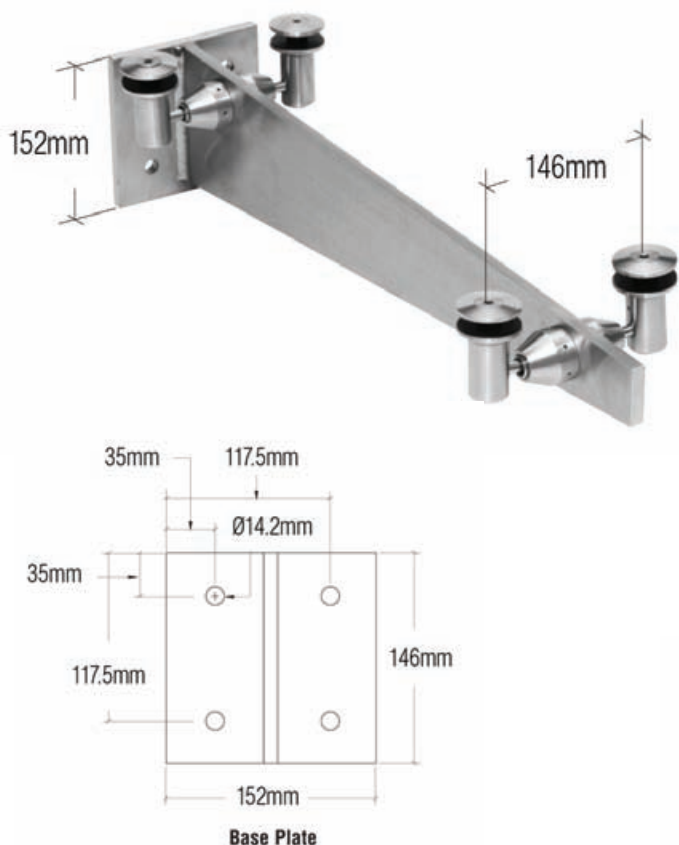

| CODE    | DESCRIPTION                                                              |
|---------|--------------------------------------------------------------------------|
| GAB24BS | CRL universal wall mounted brushed stainless 610mm glass awning bracket  |
| GAB36BS | CRL universal wall mounted brushed stainless 914mm glass awning bracket  |
| GAB48BS | CRL universal wall mounted brushed stainless 1219mm glass awning bracket |

Also available in polished stainless finish. See [crlaurence.co.uk](http://crlaurence.co.uk) for details.

Wall Mounted Bracket includes 2x Arm Fittings, Swivel or Fixed upon request

## CRL Arm Fitting

- Fabricated from 316 alloy stainless steel
- Available in brushed or polished stainless

RB50SBS

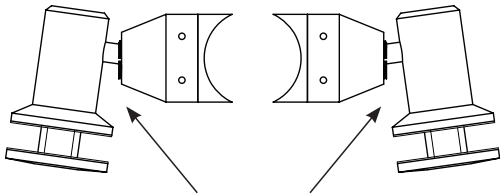

### Swivel Fitting

Designed for segment applications. Each Swivel Fitting is adjustable up to 8 degrees.



RB50FBS

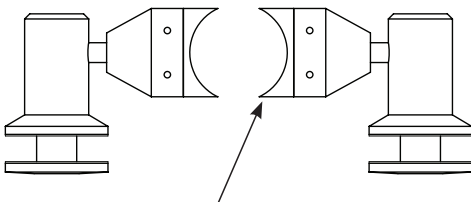

### Fixed Fitting

Designed for mounting to 38mm schedule 40 post, column, or flat wall.



| CODE    | DESCRIPTION                       |
|---------|-----------------------------------|
| RB50FBS | CRL Double Arm Fixed Fitting Set  |
| RB50FPS |                                   |
| RB50SBS | CRL Double Arm Swivel Fitting Set |
| RB50SPS |                                   |

# CRL Heavy Duty Standoffs



CRL's heavy-duty, point supported Glass Rail Standoff Fittings gives the installer more adjustment during installation for those tricky job site mounting conditions. The steel back plate can be fastened directly to steel, concrete, or wood substrates and shimmed as required with blocking.



## CODE

## DESCRIPTION

RS0B20BS  
RS0B20PS

**CRL Glass Rail Stand-off Fittings Standard 51mm Diameter Caps**

- For use with 12 or 19mm monolithic toughened glass.
- Also for use with 13.5 or 21.5mm laminated toughened glass.
- Two 19mm diameter holes per fitting
- Fabricated from 316 alloy stainless steel
- Full engineering data available at [crlaurence.co.uk](http://crlaurence.co.uk)



## CODE

## DESCRIPTION

RS0B25BS  
RS0B25PS

**CRL Glass Rail Stand-off Fittings Standard 60mm Diameter Caps**

- Ready to install
- Low maintenance with special coating to prevent corrosion
- Four standard post heights, plus a stock length so you can cut custom heights
- Custom colours also available
- Seven attractive colours, plus unfinished chromate available from stock. For details visit [crlaurence.co.uk](http://crlaurence.co.uk)
- For use with 12 or 19mm monolithic toughened glass.
- Also for use with 13.5 or 21.5mm laminated toughened glass.
- Two 19mm diameter holes per fitting
- Fabricated from 316 alloy stainless steel
- Full engineering data available at [crlaurence.co.uk](http://crlaurence.co.uk)



DuPont  
SGP Glass  
Recommended

See [crlaurence.co.uk](http://crlaurence.co.uk) for installation tools and fixings



## CRL Glass Rail Standoffs



These heavy-duty Rail Standoffs are designed for glass handrail or guardrail applications standard. The Standoff Fittings have a 44mm standard projection from the installed attachment point. Custom lengths and diameters are also available. See [crlaurence.co.uk](http://crlaurence.co.uk) for further details.



### CODE

### DESCRIPTION

RS0B2134BS  
RS0B2134PS

CRL Glass Rail Stand-off Base and Standard 51mm Diameter Cap

RS0B2135BS  
RS0B2135PS

CRL Glass Rail Stand-off Base and Domed 60mm Diameter Cap

- For Use With 12 or 19mm monolithic toughened glass
- Also for use with 13.52mm and 21.52mm laminated toughened glass
- One 19mm diameter hole per fitting
- Fabricated from 316 alloy stainless steel
- Full engineering data available at [crlaurence.co.uk](http://crlaurence.co.uk)



DuPont  
SGP Glass  
Recommended



## GLASS & STAINLESS STEEL PROTECTION

- Ideal for windows, railings, cladding and canopies
- Helps to protect stainless steel from corrosion
- 3 year protection lifespan
- Nano technology silica dioxide based solution (non silicone)
- 100m<sup>2</sup> coverage from 1000ml of product

# 6K

NEW!

Call for a demonstration and **FREE** sample pack

t: 00 800 0421 6144 | [www.crl6k.co.uk](http://www.crl6k.co.uk)



Call FREE on 00 800 0421 6144  
Fax FREE on 00 800 0262 3299



**Manchester**

Charles Babbage Avenue  
Kingsway Business Park,  
Rochdale, OL16 4NW, England  
Tel: +44 (0) 1706 863 600  
Fax: +44 (0) 1706 869 860  
[www.crlaurence.co.uk](http://www.crlaurence.co.uk)



**Stuttgart**

Boschstrasse 7  
D-74360 Ilsfeld  
Germany  
Tel: +49 (0) 7062 915 93 15  
Fax: +49 (0) 7062 915 93 16  
[www.crlaurence.de](http://www.crlaurence.de)



**Copenhagen**

Stamholmen 70 Unit B,  
DK-2650 Hvidovre  
Denmark  
Tel: +45 36 72 09 00  
Fax: +45 36 70 33 35  
[www.crlaurence.dk](http://www.crlaurence.dk)



**France**

Boschstrasse 7  
D-74360 Ilsfeld  
Germany  
Tel: +49 (0) 7062 915 93 15  
Fax: +49 (0) 7062 915 93 16  
[www.crlaurence.fr](http://www.crlaurence.fr)



View Our Full Range of  
Architectural Railing Systems...

Our EUHR11 Architectural Balustrade and Railing  
Systems Catalogue

- Glass Railings/Balustrades
- TAPER-LOC® Railing System
- Swinging Gate Systems
- Post Railing Systems
- Welded Railing Systems
- Hand Railing Systems
- Aluminium Railing Systems
- Glass Walls/Windcreens
- Tools/Accessories

You may also be interested in...

EUAH11 Architectural Hardware  
'All Glass' Entrance Systems Catalogue

- Architectural Metals
- Door and Sidelite Rails
- Door Closers
- Centre Locks
- Glass Clamps
- Headers and Channels
- Ladder Pulls
- Locking Hardware
- Door Closers and Hinges
- Patch Hardware
- Pivot Door Systems
- Push/Pull Handles
- Sliding and Stacking Glass Door Systems
- Spider Fittings
- Standoff Systems

Catalogues are available to download  
or view online at [crlaurence.co.uk](http://crlaurence.co.uk)  
or [crlaurence.de](http://crlaurence.de)

# Aluminium Railing & Windscreen Systems

Aluminium Railing System (ARS)  
Aluminium Windscreen System (AWS)

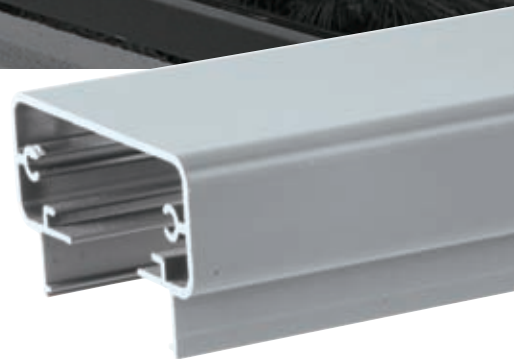



# Aluminium Railing System (ARS)





CRL's high quality commercial or residential Aluminium Railing Systems are manufactured from extruded aluminium frames utilising toughened glass or aluminium pickets.

Our railing systems provide superior colour retention, impact and weather resistance in any environment.

**CRL**<sup>®</sup>  
crlaurence.co.uk

For more information call FREE on

**00 800 0421 6144**

e: [railings\\_UK@crlaurence.co.uk](mailto:railings_UK@crlaurence.co.uk) f: 00 800 0262 3299





## Aluminium Railing Systems

- 60.3mm square posts available
- Available from stock in black, white and silver.
- Custom finishes also available

## Design Options

- Exterior and interior hand use
- Infill panel options: aluminium pickets, aluminium pattern panels, clear or coated structural glass, or stainless steel cable
- Custom gates
- ADA compliant grab rails
- Attractive low-voltage, post mounted lighting system for our railing systems. Using a safe, 12 volt power source, these lights provide a subtle glow that is sure to enhance any balcony environment. Contact CRL Technical Sales for further information.

## Component Features and Benefits

- Innovative design details for standard or custom applications
- Extruded aluminium for durability, weather resistance, and low maintenance
- Heavy gauge materials and steel embeds for strength
- Uses 6 to 12mm toughened glass for safety and impact resistance
- 6mm and 10mm using gasket. 12mm using wet glaze





## Colour Selection

- Tough, powder-coated or optional kynar paint colours for superior colour retention and weather resistance
- Special coating for resistance to salt water corrosion

## Standard Colours

- In-house factory applied
- Baked on TGIC polyester powder coat paint system
- Excellent weather resistance and durability
- Meets AAMA 2603-98 specifications

## Additional Colour Options

- A variety of textured and performance enhanced powder coat paint systems
- Custom colour matching
- All paint systems will be applied over state-of-the-art chromate pre-treatment

Stock and custom finishes are shown below with their colour codes. Add the chosen colour code to a Cat No to complete your product code.

Note: Colours shown are representative only, and may vary slightly from actual gloss, colour, and texture. If colour match is critical, please contact Technical Sales for additional information.

## Stock Finishes

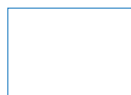

Sky White - Gloss  
CODE W



Black - Matte  
CODE BL

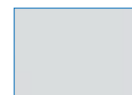

Silver - Metallic  
CODE S

## Custom finishes

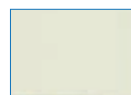

Oyster White - Gloss  
CODE OW

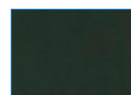

Bronze - Matte  
CODE BRZ

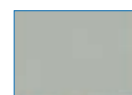

Agate Grey - Gloss  
CODE AGY

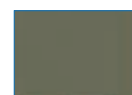

Beige Grey - Gloss  
CODE BGY

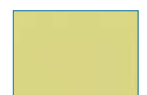

Unfinished Chromate  
CODE CRM

# CRL ARS Aluminium Railing System Mounting Options

One benefit of the ARS System is that it attaches to just about any substrate with our standard Surface Mount Base Plates. However, you do have additional mounting options, as illustrated below.

Our specially formulated coatings are designed to resist the corrosive effects of salt water, providing a permanent, worry-free addition to your building.

The CRL Aluminium Railing System is designed to meet all Guard Rail Safety Codes, and with so many options, there is a railing system for every application.

## Typical Mounting Options

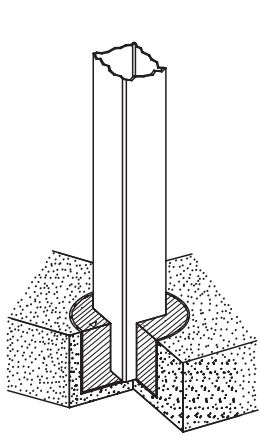

Core Mounted Installation

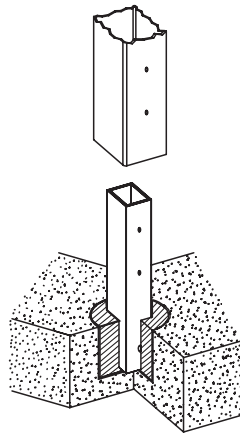

Core Mounted With Stanchion Installation

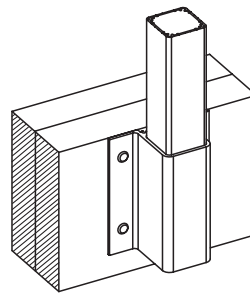

Fascia Mounted Installation

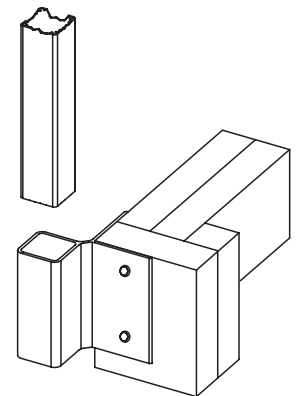

Corner Fascia Mount Installation

Core

Fascia

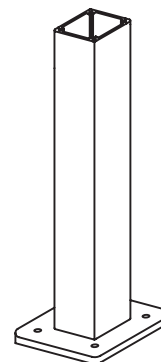
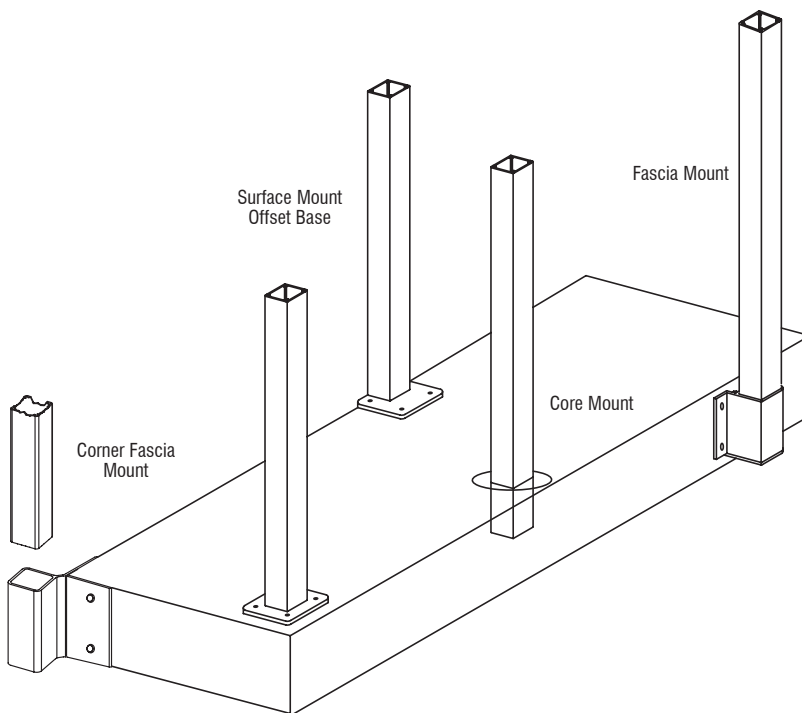

Surface Mounted Standard Base With Moisture Barrier Gasket Between Bracket and Substrate

Surface

# Basic Installation Instructions

## 1. Post Installation

Install End and Corner Posts first, then continue with Intermediate Posts. Be sure to place Stainless Steel Washers under the Bolts so that the Bolt Cover Buttons can be attached. Ensure that Posts are plumb and level. **NOTE:** When installing Post on top of concrete, brick, masonry, or stucco, always make sure to install the Moisture Barrier Gasket between the substrate and the Bottom Plate.

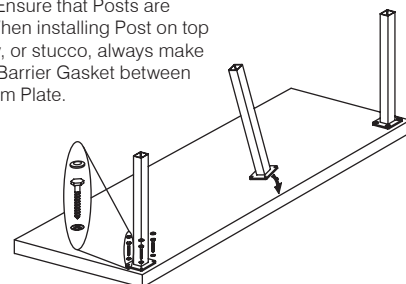

## 2. Cap Rail Installation

Measure and cut the Cap Rail to length. Attach the Cap Rail to the Posts using Self Tapping Screws. Install the End Caps with provided screws.

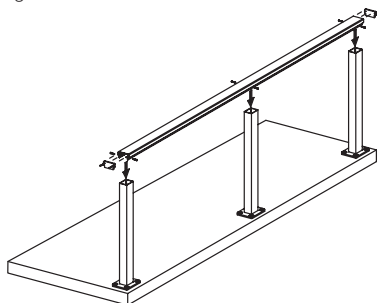

## 3. Rail Connecting Blocks

Install the Rail Connecting Blocks onto the Posts using the Self Tapping Screws provided. These Blocks are used to support the Bottom Rail.

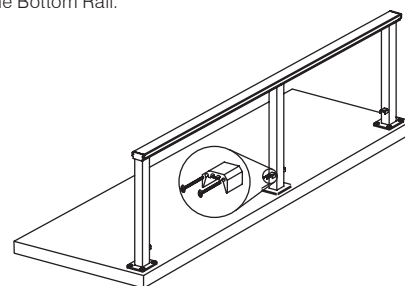

## 4. Top Rail Infill and Bottom Rail

Cut Top Rail Infill and Bottom Rail to length. Snap fit the Top Rail Infill into the Top Cap Rail. Mount the Bottom Rail onto the Blocks and secure with Tek Screws.

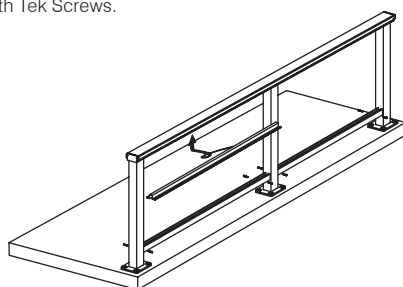

## 5. Vinyl Installation (Glass Panels Only)

Snap fit Top Vinyl into Top Cap Rail insert.  
Snap fit Bottom Vinyl into Bottom Rail.

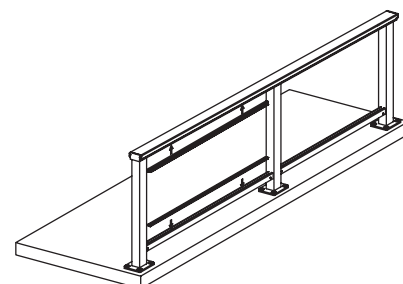

## 6. Glass Installation (Glass Panels Only)

Push Glass up into the Vinyl. Align Glass with Bottom Vinyl and push down into Vinyl. Align Glass horizontally.

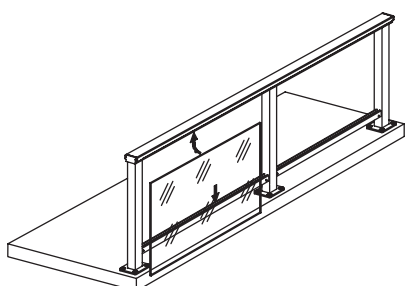

## 7. Picket Installation

Follow above steps 1, 2, and 3 only. Screw Pickets to the Top Cap Infill and the Bottom Rail. Snap fit top into Top Rail and install Bottom Rail over Blocks. Secure Bottom Rail to Blocks with Tek Screws.

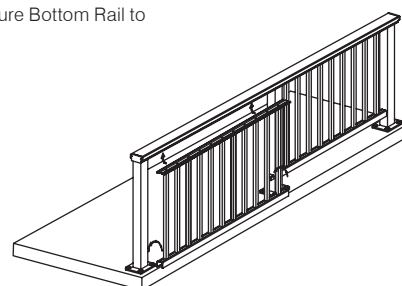



# CRL ARS 200 Series Railing System



## 200 Series

### Top Rail

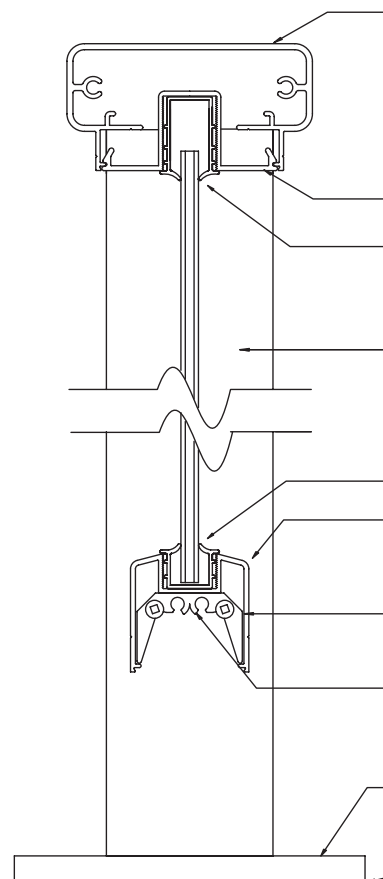
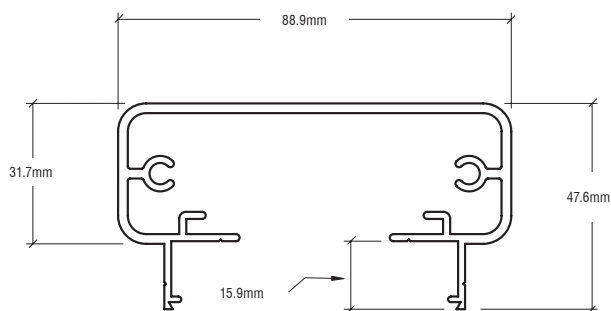

200 Series Top Rail  
Cat. No. 2TR241XX

Glass Infill  
Cat. No. 1FGLSXX

Top Glazing Vinyl  
Cat. No. 14TV (6mm)  
or 38TV (10mm)

60.3mm Square Post  
Cat. No. P241

Bottom Glazing Vinyl  
Cat. No. 14BV (6mm)  
or 38BV (10mm)

200 Series Bottom Rail  
Cat. No. BRGLSXX

Rail Connecting  
Block Screws  
Cat. No. RCBS

Rail Connecting Block  
Cat. No. RCB2

127mm Square Base Plate  
Cat. No. BP5

Moisture Barrier Gasket  
Cat. No. BPG1BL

## 200 Series

Our 200 Series Railing System uses a continuous flat top rail, which helps achieve a modern look. While most companies in the industry offer very typical top rails, the 200 Series maintains an extremely low profile while outperforming competitive systems for strength and durability. At 47.6mm it has the lowest profile of all the top rails.

**NOTE:** As good as the 200 Series is, you cannot use it for a stair application where railing is required. The top cap is too wide in cross section to achieve the status of a hand rail. This being the case, you must use our 100 Series for the stair portion of the job. Contact CRL Technical Sales for further information.



- 6005-T5 aluminium alloy
- Standard rail heights are 914, 1066 and 1219mm. Custom rail heights also available
- 60.3mm square aluminium post
- Infill panel options: 6 or 10mm glass (not supplied by CRL), 19mm square or round profile aluminium picket panels
- Also 12mm glass when used with wet glaze method 6 and 10mm using gasket
- Deck (top) mount or fascia mount applications available
- Core mount applications also available
- Can be fabricated with custom gates
- Exterior and interior applications
- A.D.A. compliant guard rails
- 1524mm recommended post spacing

## Infill Options

CRL offers glass Infill Panel System or the Picket style shown below.

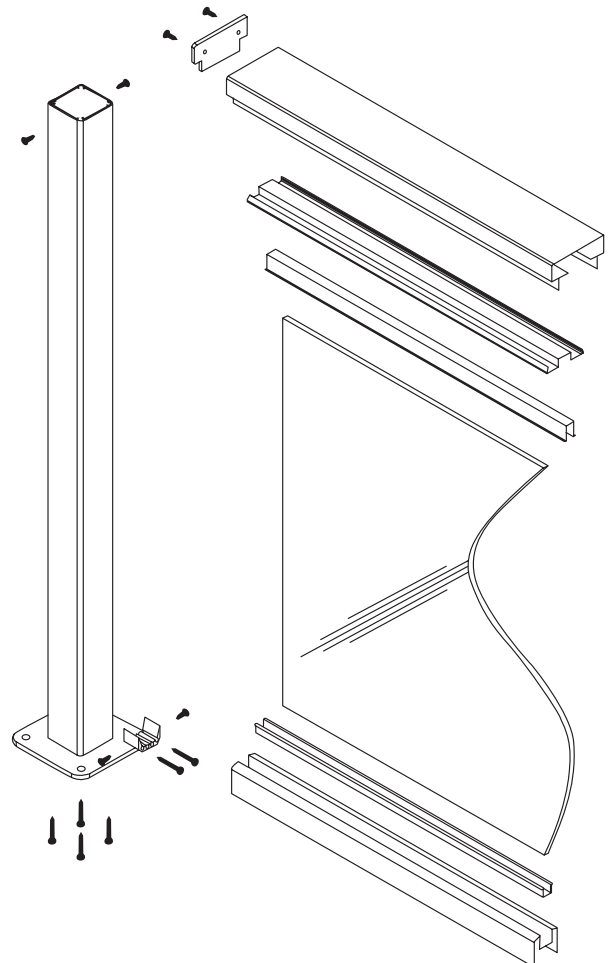
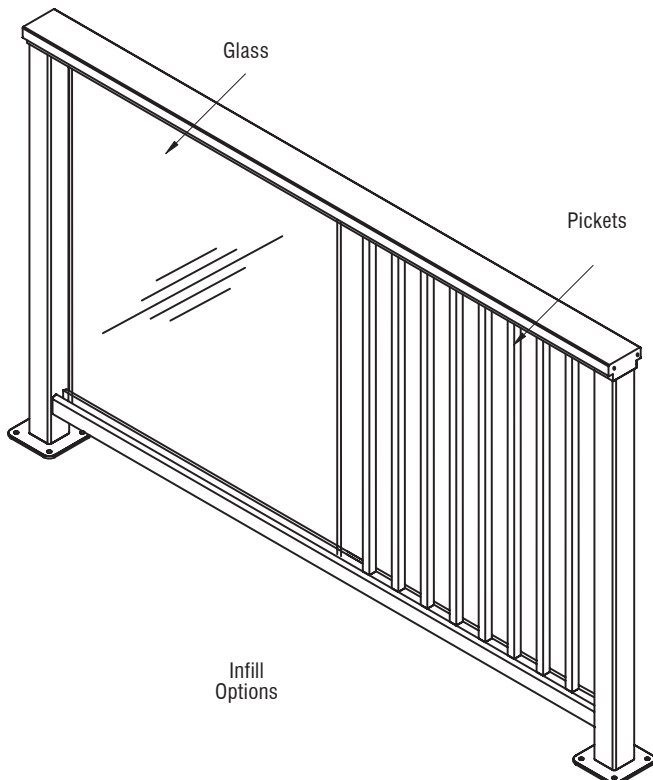



# CRL ARS 300 Series Railing System



## 300 Series

### Top Rail

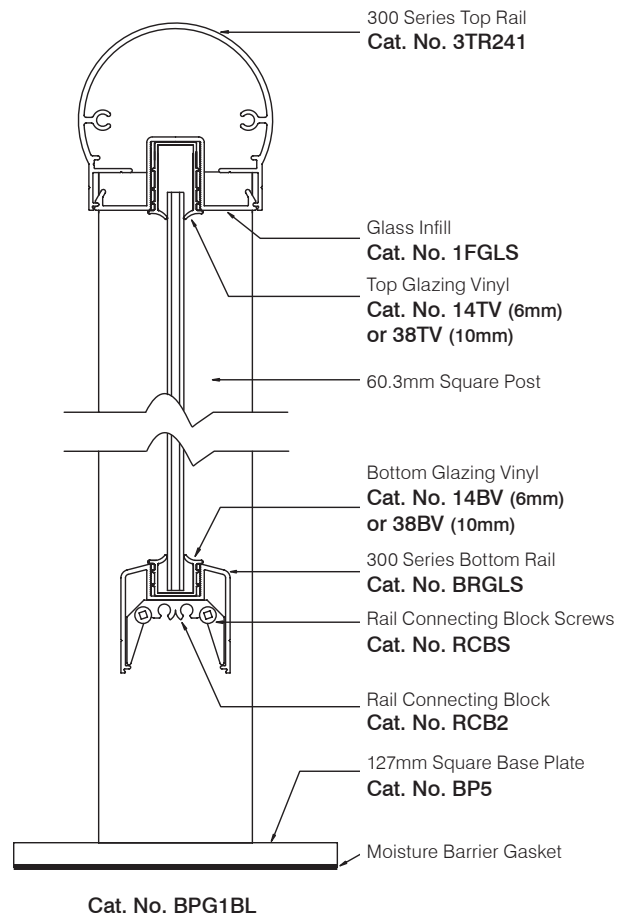
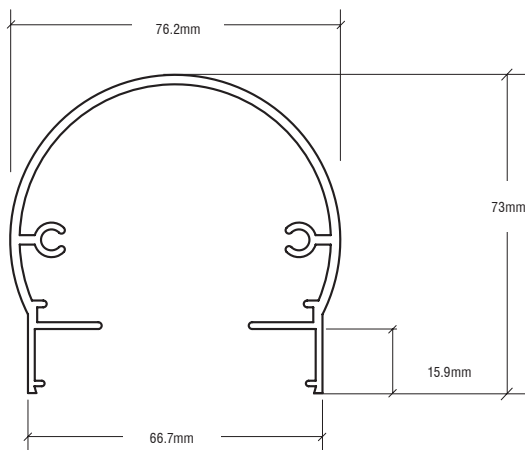

## 300 Series

The 300 Series offers the largest profile of all our top rails. At 73mm high the 300 Series offers a stylish and continuous large round top rail, while maintaining the strength and durability of all of our Aluminium Railing Systems.

**NOTE:** You cannot use the 300 Series for a stair application where railing is required. The top cap is too wide in cross section to achieve the status as a hand rail. You must use our 100 Series for the stair portion of the job. Contact CRL Technical Sales for further information.



- 6005-T5 aluminium alloy
- Standard rail heights are 914, 1066 and 1219mm. Custom rail heights also available
- 60.3mm square aluminium post
- Infill panel options 6 or 10mm glass (not supplied by CRL), 19mm square or round profile aluminium picket panels, stainless steel cable, or decorative cast panels
- Also 12mm glass when used with wet glaze method 6 and 10mm using gasket
- Deck (top) mount or fascia mount applications
- Core mount applications also available
- Exterior and interior applications
- Can be fabricated with custom gates
- A.D.A. compliant guard rails
- 1524mm recommended post spacing

## Infill Options

CRL offers glass Infill Panel System or the Picket style shown below.

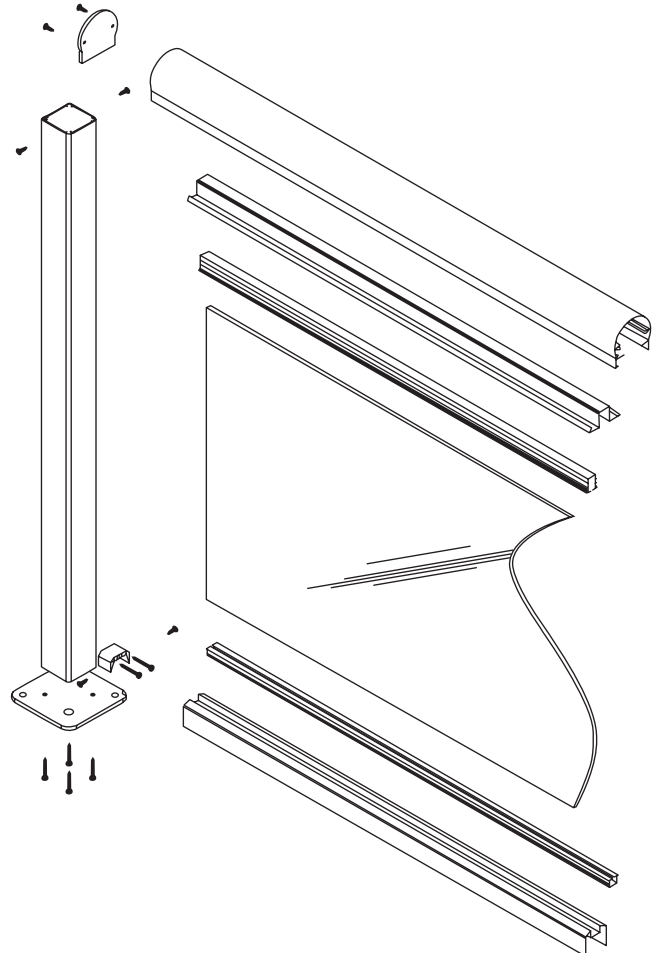
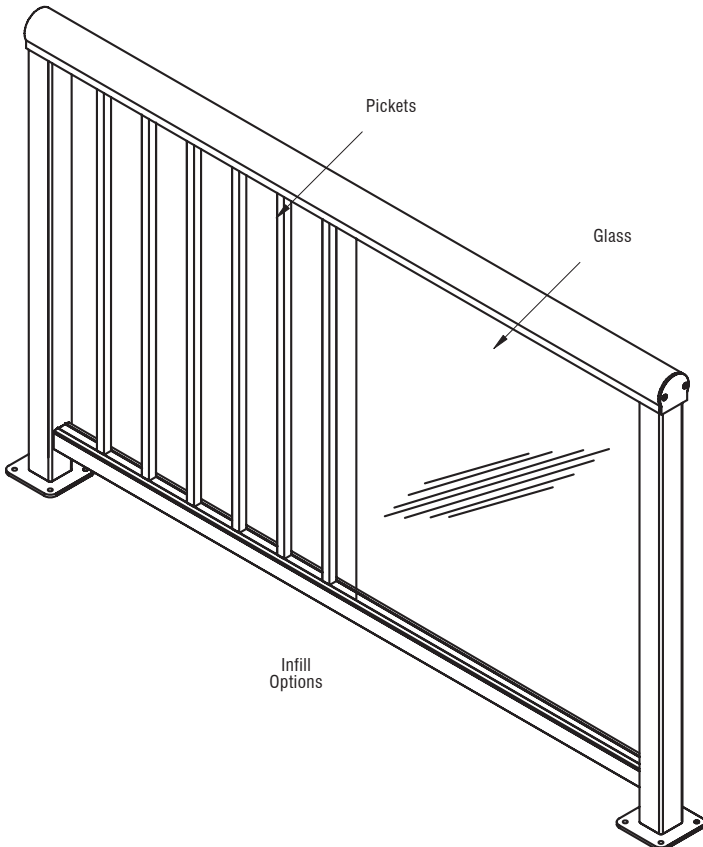

**CODE DESCRIPTION**



**200 Series**

**2TR241XX**

**200 Series Top Rail**

- Designed to accommodate 19mm pickets or 6 to 12mm\* toughened glass
- \* 12mm glass only if wet glazed. 6 and 10mm using gasket.

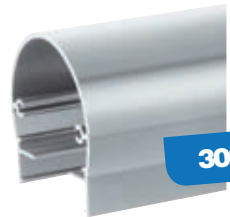
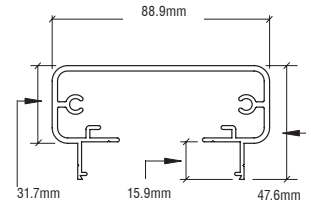

**300 Series**

**3TR241XX**

**300 Series Top Rail**

- For use with 19mm pickets or 6 to 12mm\* toughened glass
- \* 12mm glass only if wet glazed. 6 and 10mm using gasket.

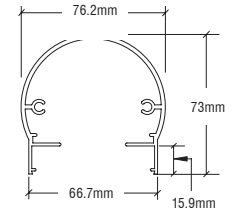

## CRL Top Rail Infills

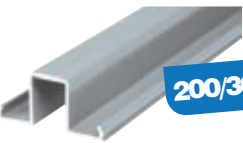

**200/300 Series**

**1FGLSXX**

**Top Rail Infill for Glass**

- Easily snap into the underside of the top rail
- For use with 19mm Pickets or 6 to 12mm\* toughened Glass
- \* 12mm glass only if wet glazed. 6 and 10mm using gasket.

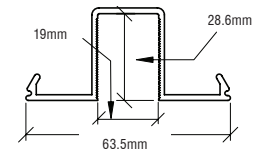

**200/300 Series**

**IFPKTXX**

**Top Rail Infill for Pickets**

- Easily snap into the underside of the top rail
- For use with 19mm square or round pickets
- Also available pre-punched for pickets.

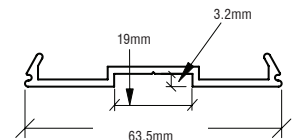

## CRL Glazing Vinyl



**200/300 Series**

**14TV**  
Top Vinyl for 6mm Thick Glass

**38TV**  
Top Vinyl for 10mm Thick Glass

**Glazing Vinyl Top**

- Rigid glazing vinyl is designed to snap in before the glass is installed
- Two sizes for use with 6 or 10mm thick toughened glass

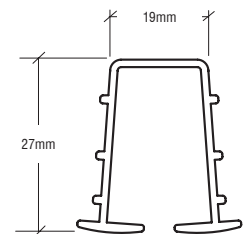

**200/300 Series**

**14BV**  
Bottom Vinyl for 6mm Thick Glass





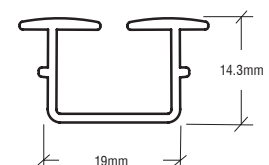

**38BV**  
Bottom Vinyl for 10mm Thick Glass

**Glazing Vinyl Bottom**

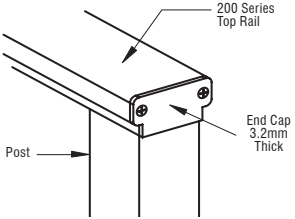

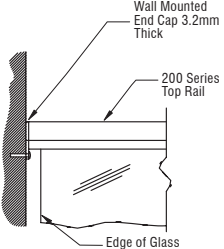
- Rigid glazing vinyl is designed to snap in before the glass is installed
- Two sizes for use with 6 or 10mm thick toughened glass

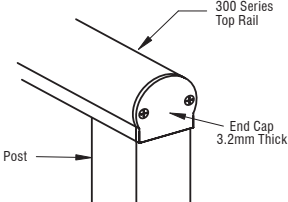

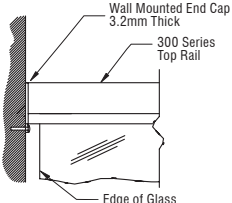
# CRL End Caps for 200 and 300 Series Rails

| CODE                                                                                                                | DESCRIPTION                                                                                                                                                                                                                                                                                    |
|---------------------------------------------------------------------------------------------------------------------|------------------------------------------------------------------------------------------------------------------------------------------------------------------------------------------------------------------------------------------------------------------------------------------------|
| <p>2DECXX</p>  <p>200 Series</p>   | <p><b>Decorative End Caps</b></p> <ul style="list-style-type: none"> <li>Countersunk for end cap screws</li> <li>Matches contours of top rail</li> <li>ECS1 screws sold separately</li> </ul>               |
| <p>2WECXX</p>  <p>200 Series</p>   | <p><b>Wall Mount End Caps</b></p> <ul style="list-style-type: none"> <li>Countersunk for end cap screws</li> <li>Designed for wall mounting the top rail</li> <li>ECS1 screws sold separately</li> </ul>    |
| <p>3DECXX</p>  <p>300 Series</p>  | <p><b>Decorative End Caps</b></p> <ul style="list-style-type: none"> <li>Countersunk for end cap screws</li> <li>Matches contours of top rail</li> <li>ECS1 screws sold separately</li> </ul>              |
| <p>3WECXX</p>  <p>300 Series</p> | <p><b>Wall Mount End Caps</b></p> <ul style="list-style-type: none"> <li>Countersunk for end cap screws</li> <li>Designed for wall mounting the top rail</li> <li>ECS1 screws sold separately</li> </ul>  |

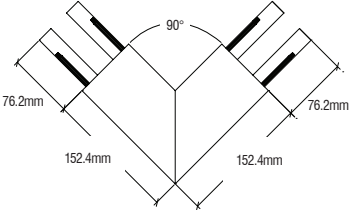
# CRL 90 Degree Horizontal Corners

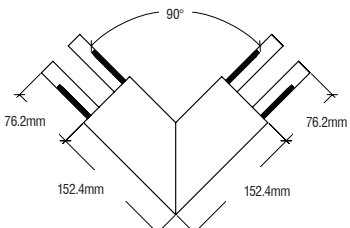
|                                                                                                                    |                                                                                                                                                                                                                                                                                                                                                                                                   |
|--------------------------------------------------------------------------------------------------------------------|---------------------------------------------------------------------------------------------------------------------------------------------------------------------------------------------------------------------------------------------------------------------------------------------------------------------------------------------------------------------------------------------------|
| <p>2TRHXX</p>  <p>200 Series</p> | <p><b>CRL 200 Series 90 Degree Horizontal Corners</b></p> <ul style="list-style-type: none"> <li>Welded and finished</li> <li>Matches shape of top rail</li> <li>Includes aluminium connector splice plates</li> <li>6005 Alloy aluminium/T5 temper</li> <li>Custom angle corners also available</li> </ul>  |
| <p>3TRHXX</p>  <p>300 Series</p> | <p><b>CRL 300 Series 90 Degree Horizontal Corners</b></p> <ul style="list-style-type: none"> <li>Welded and finished</li> <li>Matches shape of top rail</li> <li>Includes aluminium connector splice plates</li> <li>6005 Alloy aluminium/T5 temper</li> <li>Custom angle corners also available</li> </ul>  |



# CRL 135 Degree Horizontal Corners

CODE

DESCRIPTION

200 Series

2TRH3XX

**CRL 200 Series 135 Degree Horizontal Corners**

- Welded and finished
- Matches shape of top rail
- Includes aluminium connector splice plates
- 6005 Alloy aluminium/T5 temper
- Custom angle corners also available

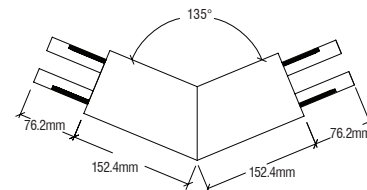

300 Series

3TRH3XX

**CRL 300 Series 135 Degree Horizontal Corners**

- Welded and finished
- Matches shape of top rail
- Includes aluminium connector splice plates
- 6005 Alloy aluminium/T5 temper
- Custom angle corners also available

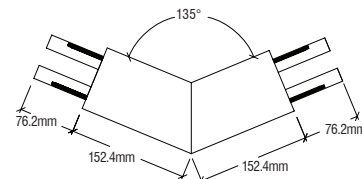

## CRL Corner Brackets

45CB

**135 Degree Corner Bracket**

- For use with 200 and 300 Series
- Designed to fit underneath our top rails.
- Brackets are held in place with four Cat. No. TEK1 self-tapping tek screws
- Aluminium brackets are concealed under the top rail to connect corners.

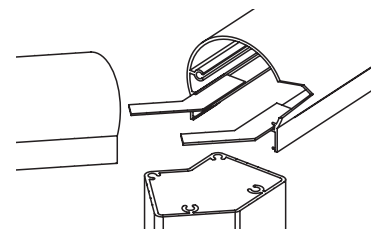

90CB

**90 Degree Corner Bracket**

- For use with 200 and 300 Series
- Designed to fit underneath our top rails.
- Brackets are held in place with four cat. No. TEK1 self-tapping tek screws
- Aluminium brackets are concealed under the top rail to connect corners.

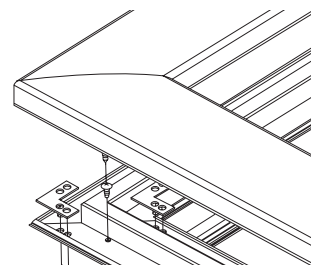

## CRL Splice Plates

200/300 Series

TCP1

**CRL Splice Plates for Rails**

- For use with 200 and 300 Series
- Aluminium splice plates fit under top rail to splice top rails together over a post
- Plates are held in place with two self-tapping screws (Cat. No. TEK1)
- Two plates are required at each splice point

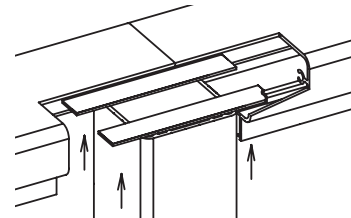

## CRL Adjustable Fastening Plates

CB350L

Left Hand Plate

**CRL Adjustable Fastening Plates for Top Rails**

- For use with 200 and 300 Series
- Aluminium plates attach to top of vertical post then to top rail
- No exposed screws design

CB350R

Right Hand Plate  
(not shown)

CBS1

19mm Screw

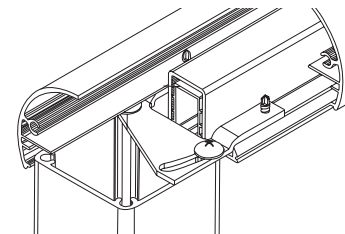

# CRL Horizontal Mid Rail and Infill for Glass

CODE DESCRIPTION



MR1XX

### CRL Horizontal Mid-Rail

- For use with 200 and 300 Series
- Designed to accommodate 6 to 12mm glass or 19mm square pickets. 6 and 10mm using gasket. 12mm glass when used with wet glaze method
- Custom powder coat colours also available
- Designed to be anchored between posts using RCB2 mounting blocks

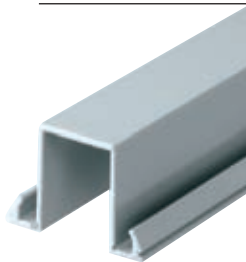
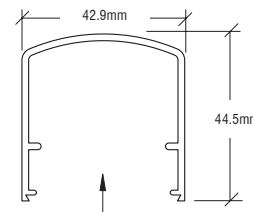

MR1FXX

### CRL Horizontal Snap-In Infill for Glass

- Designed to accommodate 6 to 12mm glass. 6 and 10mm using gasket. 12mm glass when used with wet glaze method
- Designed to be anchored between posts using RCB2 mounting blocks
- Custom powder coat colours also available
- Snaps in from the underside of the horizontal mid-rail

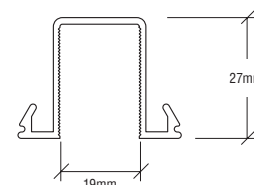

## CRL Bottom Rails



BRGLSXX

### CRL Bottom Glass Rail

- For use with 200 and 300 Series
- Bottom rail designed to accommodate 6 to 12mm toughened glass. 6 and 10mm using gasket. 12mm glass when used with wet glaze method

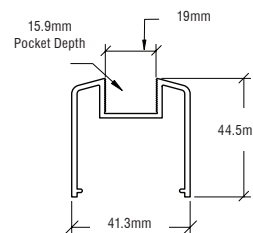

BRPKTXX

### CRL Bottom Picket Rail

- For use with 200 and 300 Series
- Designed to accommodate 19mm square or round pickets
- Optional bottom rail filler available

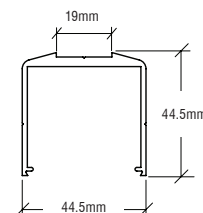

BRF241XX

### CRL Standard Bottom Rail Filler

- Snaps in to conceal the underside of bottom rails and create a flush look
- Works with bottom rail for glass or bottom rail for pickets
- Also works with horizontal mid rails

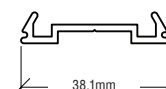

## CRL Intermediate Bottom Support



1BSXX

### CRL Intermediate Bottom Support

- For use with all of our aluminium railings
- Connects to bottom rail with two self-tapping screws (Cat. No. TEK1)

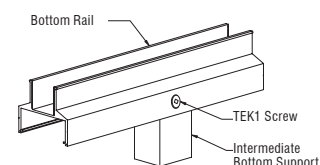

# CRL Rail Connecting Blocks & Screws

## CODE

## DESCRIPTION

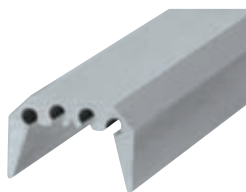

200/300 Series

**RCB2**  
25.4mm

**RCB212**  
305mm

**RCB2241**  
6.12m

### CRL Rail Connecting Blocks

- For use with 200 and 300 Series
- Designed for use when installing bottom rails
- Three standard lengths available

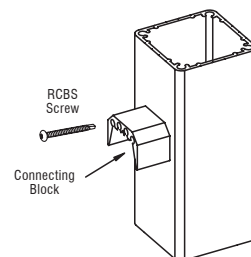

**RCBS**  
Rail Connecting  
Block Screw

**9502**  
Square insert bit  
for screw

**TEK1**  
Rail Fastening Screw

**ECS1**  
Endcap Screws

### CRL Rail Connecting Block & CRL TEK Screws

- For all CRL railings
- Self-tapping
- Stainless steel

# CRL Square Posts & Kits

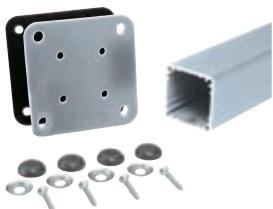

**P36KXX**  
914mm Post Kit

**P42KXX**  
1066mm Post Kit

**P48KXX**  
1219mm Post Kit

### CRL Surface Mount Post Kits

- 60.3mm square
- Use for 180 degree, 90 degree or end posts
- Three standard post heights
- Complete with base plate, stainless washers, screws, and bolt cover buttons

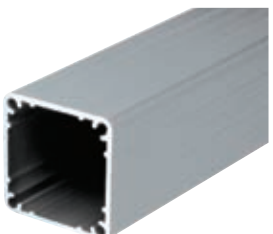

**P241XX**  
6.12m Stock Length

### CRL Posts Only

- 60.3mm square
- Use for 180 degree, 90 degree or end posts
- 6005 Alloy aluminium/T5 temper

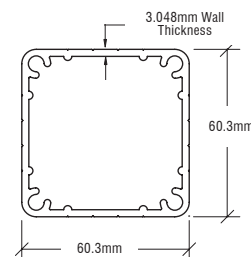

# CRL 90 Degree Fascia Mount Brackets

CODE

DESCRIPTION



FB2XX

## CRL 90 Degree Fascia Mount Brackets

- Specifically designed for outside 90 degree fascia mount installations
- Works with almost any deck
- 200 series only

Works with CRL Posts  
Cat. No. P241

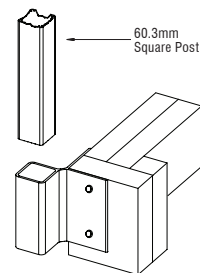

FB1XX

## CRL Fascia Mount Brackets

- Black, white and silver finishes available from stock - custom finishes also available. For details visit [crlaurence.co.uk](http://crlaurence.co.uk)
- Available to Match All CRL Aluminium Railings Using Our 60.3mm square aluminium posts

Works with CRL Posts  
Cat. No. P241

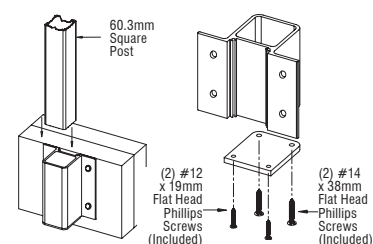

# CRL 135 Degree Surface Mount Posts & Kits

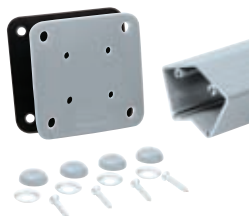

P536KXX

914mm Post Kit

P542KXX

1066mm Post Kit

P548KXX

1219mm Post Kit

## CRL 135 Degree Surface Mount Post Kits

- Three standard post heights
- Complete with base plate, moisture barrier gasket, screws, stainless washers, and bolt cover buttons
- Designed to be installed onto concrete, wood, steel, and other substrates



P5241XX

6.12m Stock Length

## CRL 135 Degree Posts Only

- Stock length you can cut to the needed size
- Black, white and silver finishes available from stock - custom finishes also available. For details visit [crlaurence.co.uk](http://crlaurence.co.uk)
- Surface mount only

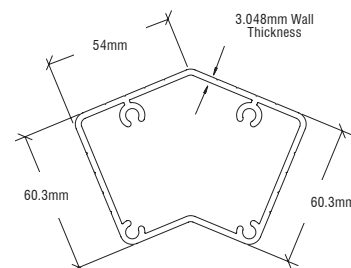



# CRL Touch-Up Paint

## CODE

## DESCRIPTION



SP8XX

### CRL Touch-Up Paint

- Matches seven CRL powder paint colours
- Used to cover scratches or bare metal ends
- Stock colours shown below. Other colours available for custom orders.



Sky White - Gloss



Black - Matte

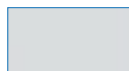

Silver - Metallic



# CRL Screws, Bolts & Anchors

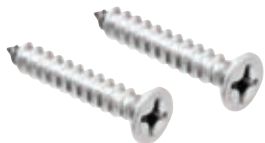

BPS112

Base Plate Screw

### CRL Base Plate Screws

- For use with all square base plates
- Stainless steel

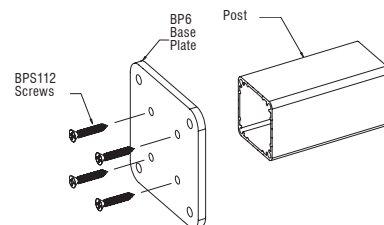

LB350

Lag Bolt  
9.5mm x 88.9mm

LB600

Lag Bolt  
9.5mm x 152.4mm

### CRL Lag Bolts

- Attach vertical posts to a wooden substrate
- Stainless steel

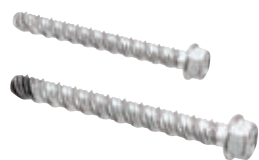
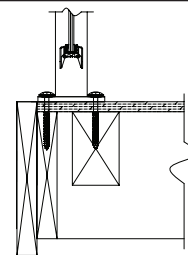

WBA14X3

Wedge Bolt Anchor  
6.3mm x 76.2mm

WBA38X4

Wedge Bolt Anchor  
9.5mm x 101.6mm

### CRL Wedge Bolt Concrete Anchors

- To attach vertical posts to concrete substrate
- Heat treated carbon steel

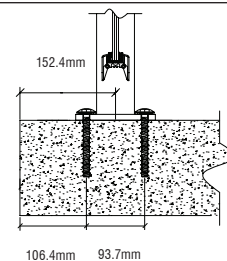

CA325

Stainless Steel Anchor  
6.3mm x 82.5mm

### CRL Stainless Steel Concrete Anchors

- To attach vertical posts to concrete substrate

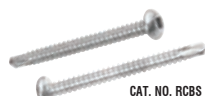
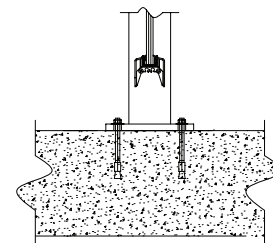

CAT. NO. RCBS

RCBS

Rail Connecting Block  
Screw #10 x 50.8mm



CAT. NO. TEK1

TEK1

Rail Fastening Screw  
#8 x 19mm



CAT. NO. 9502

9502

Square Insert Bit for Screw



CAT. NO. ECS1

ECS1

End Cap Screws

### CRL Stainless Steel Self Drilling Railing Screws

# CRL Standard Square Base Plates

CODE

DESCRIPTION



BP5XX

### CRL Square Base Plate

- For use with all standard railings
- For 60.3mm square aluminium posts
- Complete with moisture barrier gasket

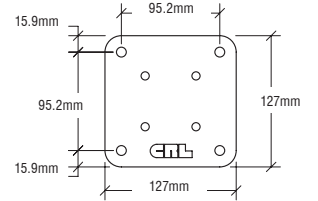

BP05XX

### CRL Offset Base Plate

- For use with all standard railings
- For 60.3mm square aluminium posts
- Complete with moisture barrier gasket

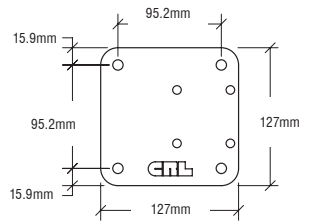

**BPG1BL**  
127mm x 127mm

**BPG2BL**  
152mm x 152mm

**BPG3BL**  
165.1mm x 165.1mm

### CRL Moisture Barrier Gaskets for Square Base Plates

- Protects metal base plates from moisture in concrete
- Three sizes available
- For aluminium railings and windscreens
- 3.2mm thick



**PST5**  
Core Mount

**\*PST5BP**  
Surface Mount

### CRL ARS Stanchions

- Designed for all series of CRL aluminium railings using our 60.3mm square aluminium posts
- Stainless steel
- Stanchion height of 254mm

\*Specify powder coat colour when ordering.

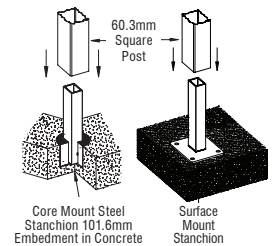

CVR5XX

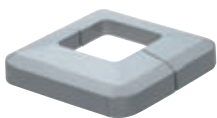

### CRL Aluminium Base Plate Cover

- Designed for use with our standard 60.3mm square aluminium posts and 127mm square base plates
- For surface or core mounted installations
- Custom powder coat colours also available

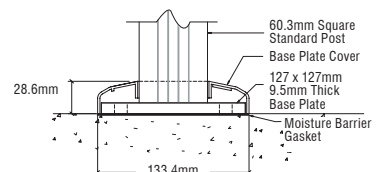

# CRL Pickets & Picket Panels

## CODE

## DESCRIPTION



### P4836XX

Fits opening  
1219mm x 914mm  
Actual size  
1362mm x 841mm

(9 other sizes available  
for details visit  
[crlaurence.co.uk](http://crlaurence.co.uk))

### CRL Picket Panels for Rails

- Nine standard picket panel sizes
- Custom picket panels also available

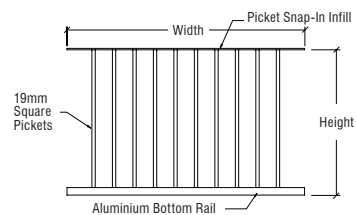

### PKTS241XX

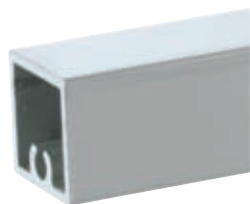

### CRL Square Pickets

- 6.12m extrusions you cut to required lengths
- Easy to install design

Use with PKTS2 Picket Screws

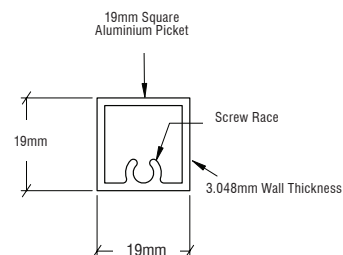

### PKTR241XX



### CRL Round Pickets

- 6.12m extrusions you cut to required lengths
- Easy to install design

Use with PKTS2 Picket Screws

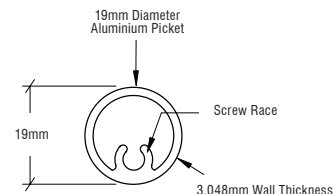

# CRL Sealants & Cements



KWX25 11.3kg  
KWX50 22.7kg

### CRL Kwixset® Expanding Cement

- Kwixset® for exterior and interior applications
- Great for setting core mount stanchions for vertical posts
- Expand as it sets
- Fast setting, it will not shrink or crack when used as directed



95CBL Black  
95CDBRZ Dark Bronze  
95CGRY Grey  
95CL Limestone  
95CW Precast White  
95CWHT White

### CRL 95C Silicone Building Sealant

- Excellent primerless adhesion to most common construction substrates
- Excellent adhesive for setting windscreen posts to stanchions
- Long tooling time, all temperature gunning
- Available in six colours

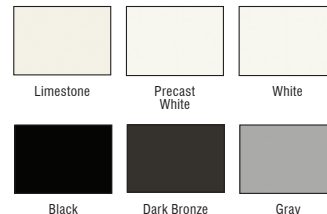

EURTV408C Clear  
EURTV408W White  
EURTV408BL Black

### CRL Neutral Cure Silicone Sealant

- Low odour, non-acetic cure formula
- Compatible with insulating glass glazing
- Excellent adhesion to most surfaces
- 300ml cartridge
- 12 per case

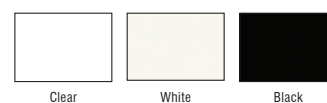









# Aluminium Windscreen System (AWS)



The AWS Aluminium Windscreen System was developed to provide an attractive, maintenance-free glass wall. All AWS Systems can be used in conjunction with a concrete slab, block wall or individual footings.

**Visual Appeal** The Homeowner will love the clean look of this wall and the virtually unobstructed view it provides.

**Noise Reduction** The AWS System is superbly suited as a sound wall along busy streets and highways. Our system provides a much higher sound transmission rating than conventional fencing.

**Maintenance** The AWS System is low maintenance. All components are specially coated to prevent corrosion and ensure that the homeowner will be satisfied for many years.

**Flexibility** The AWS System adapts to a wide variety of terrain and wall designs. The system is ideal for pool areas, decks and balcony applications.

**Integrity** The AWS System has been designed to provide a safe, transparent fence during high wind conditions. All glass installed must be fully toughened to meet all safety requirements and building codes.

For more information call FREE on

**00 800 0421 6144**

e: [railings\\_UK@crlaurence.co.uk](mailto:railings_UK@crlaurence.co.uk) f: 00 800 0262 3299



# CRL AWS Aluminium Windscreen System



- Steel embedment keeps aluminium posts out of contact with concrete, and adds structural strength
- Ready to install
- Low maintenance with special coating to prevent corrosion
- Custom colours also available

Unlike other glass wind wall systems, the AWS Aluminium Windscreen System keeps all aluminium out of contact with concrete.

The AWS System was designed to be a wind wall that is very aesthetically pleasing. Because of the great design and the interaction with the steel insert, AWS has enhanced structural properties, allowing for increased height and span capabilities.

## Available Post Configurations

### 50.8 x 66.7mm Rectangular Aluminium Windscreen Post Profiles

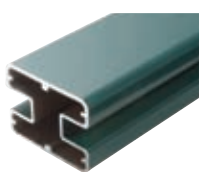

180 Degree Centre/  
End Post Kits



90 Degree  
Post Kits



135 Degree  
Post Kits

### 76.2mm Round Aluminium Windscreen Post Profiles



180 Degree Centre/  
End Post Kits



90 Degree  
Post Kits

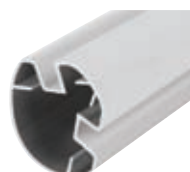

135 Degree  
Post Kits

Stock and custom finishes are shown below with their colour codes. Add the chosen colour code to a Cat No to complete your product code.

Note: Colours shown are representative only, and may vary slightly from actual gloss, colour, and texture. If colour match is critical, please contact Technical Sales for additional information.

## Stock Finishes

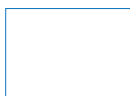

Sky White - Gloss  
CODE W



Black - Matte  
CODE BL

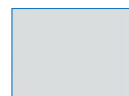

Silver - Metallic  
CODE S

## Custom finishes

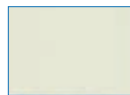

Oyster White - Gloss  
CODE OW

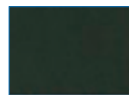

Bronze - Matte  
CODE BRZ

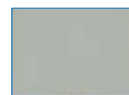

Agate Grey - Gloss  
CODE AGY

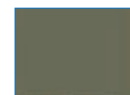

Beige Grey - Gloss  
CODE BGY



Unfinished Chromate  
CODE CRM

## Additional Colour Options

- A variety of textured and performance enhanced powder coat paint systems
- Custom colour matching
- All paint systems will be applied over state-of-the-art chromate pre-treatment

# CRL AWS Aluminium Windscreen System Mounting Options



Unlike other glass wind wall systems, the AWS Aluminium Windscreen System keeps all aluminium out of contact with concrete. The lime in concrete is very corrosive to aluminium, and over time will degrade the physical properties of the components. The AWS System utilises a painted steel embedment that supports the vertical post and eliminates the possibility of damaging corrosion.

An added benefit of the steel embedment is that the contractor can install the steel components early in the construction process, then install the painted aluminium post later when the chances of damage by other tradesmen are greatly reduced. These are strong attributes of the AWS System, and have a real value to the builder and homeowner.

## Typical Mounting Options

**Core Mounted Installation for a Concrete Slab**

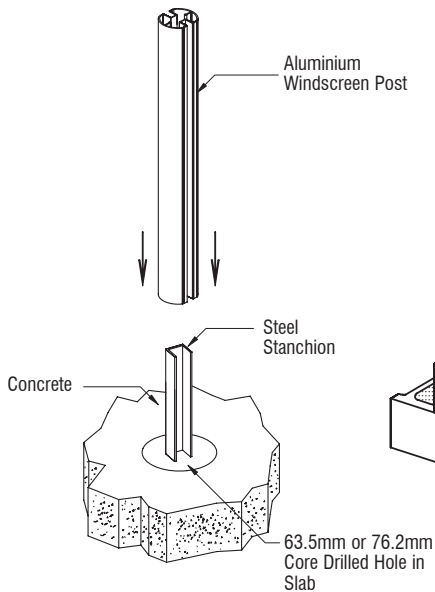

**Core Mounted Installation for CMU Block Walls**

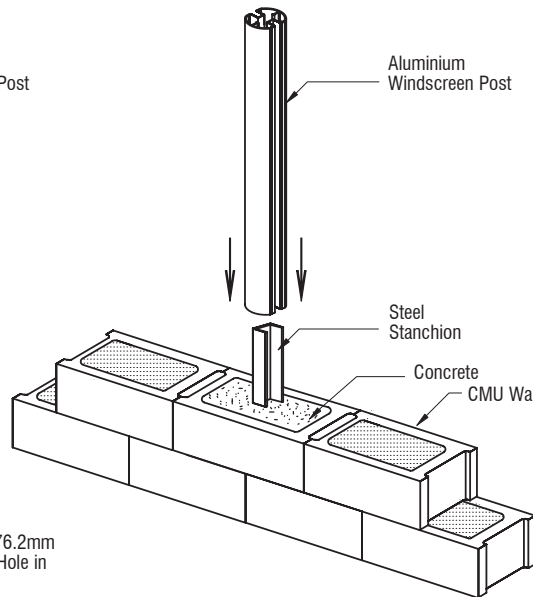

**Surface Mounted Installation for a Concrete Slab**

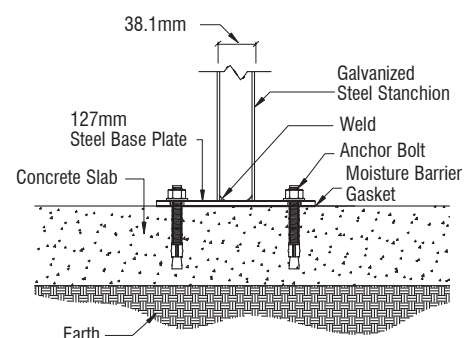
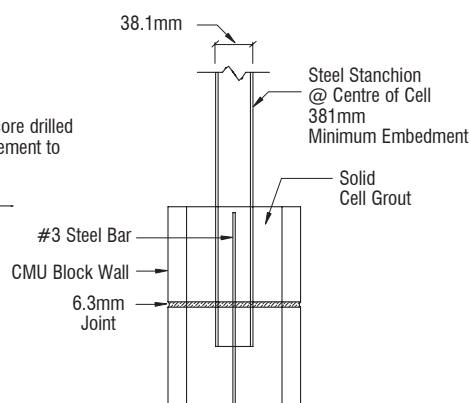
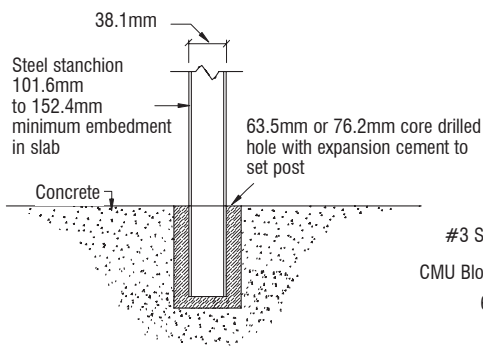
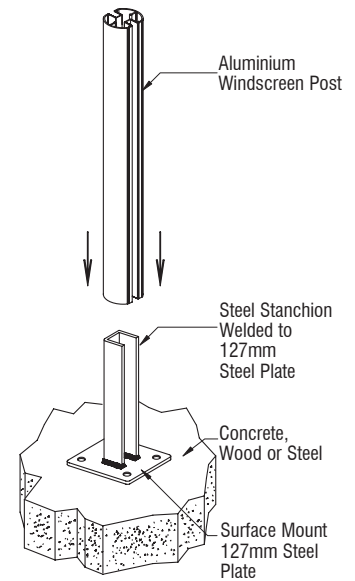



# Basic Installation Instructions

- 1.**
- Core mount or surface mount the Steel Stanchions, starting with the End and Corner Posts first.
  - Then run a straight line between your End Posts and/or Corner Posts before you set the Intermediate Posts.
  - Be sure the Stanchions are plumb and level.
  - Note: When surface mounting to concrete, brick, masonry, or stucco make sure to install the Moisture Barrier Gasket between the bottom plate and substrate to prevent metal corrosion.

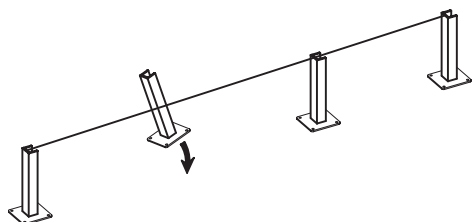

- 2a.**
- Once the Steel Stanchions are installed, apply CRL 95C Silicone to the Stanchion before mounting the Post into place.
  - If you are installing a Surface Mount Bottom Rail, measure and cut to the desired size, then install the Surface Mount Bottom Rail onto the substrate using CRL 95C Silicone.
  - Note: Surface Mount Bottom Rails are optional when installing the AWS System.

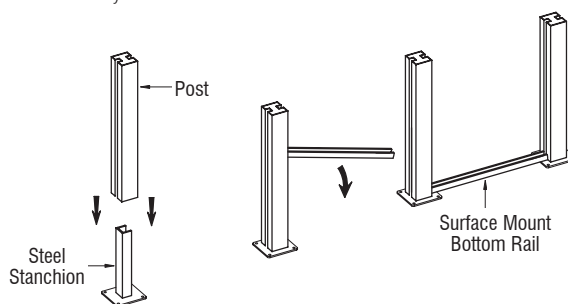

- 2b.**
- If you are installing an Elevated Bottom Rail, Rail Connecting Blocks must be installed first.
  - Install the Rail Connecting Blocks onto the Post using Cat. No. RCBS Self Tapping Screws. These Blocks are used to support the Bottom Rail.
  - NOTE: Elevated Bottom Rails are optional when installing the AWS System.

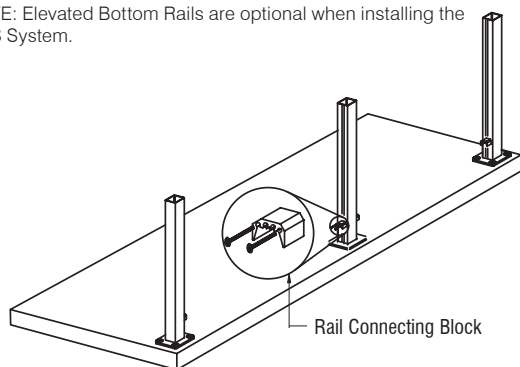

- 2c.**
- Cut Elevated Bottom Rail to length. Mount the Bottom Rail onto the Blocks and secure with Cat. No. TEK1 Tek Screws.

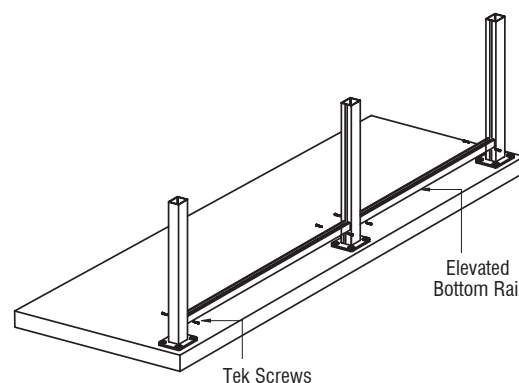

- 3.**
- When installing the glass panels, make sure the rigid vinyl is installed into the glass pocket before installing the panels.
  - Slide the glass panels down from the top of the Post. Make sure the vinyl is lubricated to protect the vinyl from damage during installation.

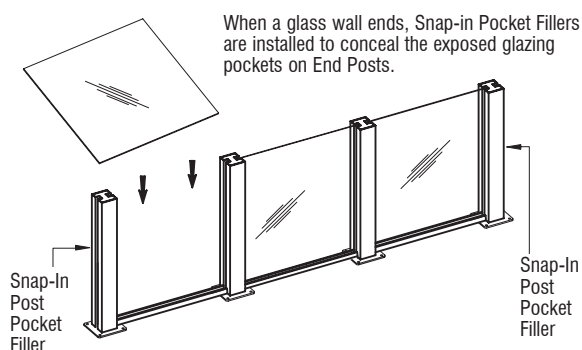

- 4.**
- Install Post Caps with CRL 95C Silicone.
  - To protect the glass from debris over time, use CAT. No. N56025 Surface Protector to seal the glass.

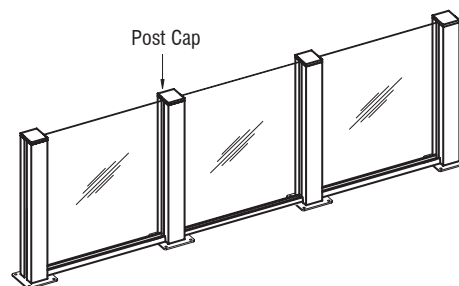

# CRL AWS Rectangular Posts & Kits

## CODE

## DESCRIPTION

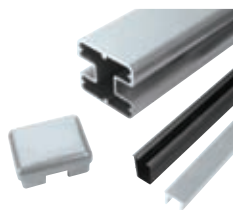

**S36CKXX** 914mm  
**S48CKXX** 1219mm  
**S60CKXX** 1524mm  
**S72CKXX** 1829mm  
  
**S36EKXX** 914mm  
**S48EKXX** 1219mm  
**S60EKXX** 1524mm  
**S72EKXX** 1829mm

### CRL AWS 50.8 x 66.7mm Rectangular 180 Degree Centre or End Post Kits

- Standard kits include post, top cap, and vinyl
- Custom colours available upon request
- Accommodates 6 to 10mm glass dry glazed with vinyl
- Accommodates 12mm glass wet glazed

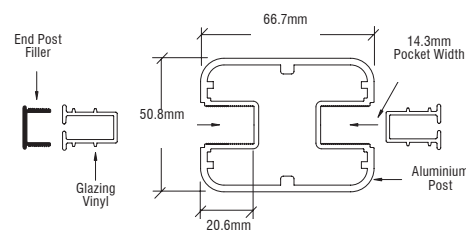

**S194XX** 6.12m

### CRL AWS 50.8 x 66.7mm Rectangular 180 Degree Centre or End Post Only

- Ready to install
- Low maintenance with special coating to prevent corrosion
- 6.12m stock length so you can cut custom heights
- Custom colours also available

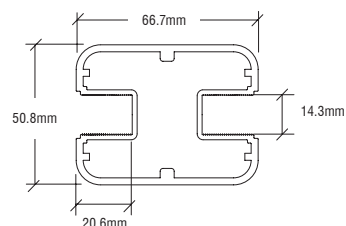

# CRL AWS Rectangular 90 Degree Corner Posts & Kits

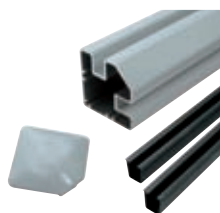

**S36CRKXX** 914mm  
**S48CRKXX** 1219mm  
**S60CRKXX** 1524mm  
**S72CRKXX** 1829mm

### CRL AWS 50.8 x 66.7mm Rectangular 90 Degree Corner Post Kits

- Standard kits include post, top cap, and vinyl
- Custom colours available upon request
- Accommodates 6 to 10mm glass dry glazed with vinyl
- Accommodates 12mm glass wet glazed

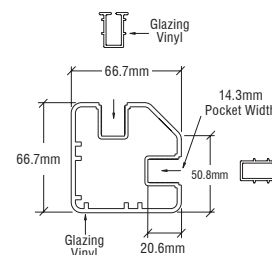

**SP9194XX** 6.12m

### CRL AWS 50.8 x 66.7mm Rectangular 90 Degree Corner Post Only

- Ready to install
- Low maintenance with special coating to prevent corrosion
- 6.12m stock length so you can cut custom heights
- Custom colours also available

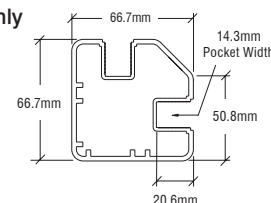

# CRL AWS Rectangular 135 Degree Corner Posts & Kits

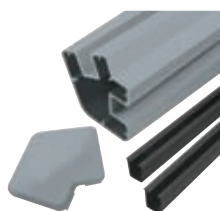

**S365KXX** 914mm  
**S485KXX** 1219mm  
**S605KXX** 1524mm  
**S725KXX** 1829mm

### CRL AWS 50.8 x 66.7mm Rectangular 135 Degree Post Kits

- Standard kits include post, top cap, and vinyl
- Custom colours available upon request
- Accommodates 6 to 10mm glass dry glazed with vinyl
- Accommodates 12mm glass wet glazed

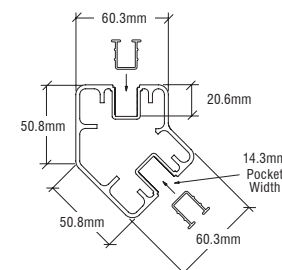

**SP5241XX** 6.12m

### CRL AWS 50.8 x 66.7mm Rectangular 135 Degree Posts Only

- Ready to install
- Low maintenance with special coating to prevent corrosion
- 6.12m stock length so you can cut custom heights
- Custom colours also available

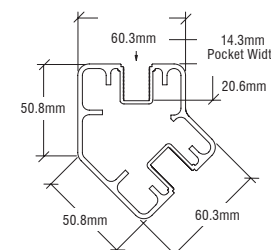

## CRL AWS Rectangular Aluminium Windscreen System



- Great for pools, balconies, fencing, steps, slopes, and many other options
- Low maintenance with all components specially coated to prevent corrosion
- Will accommodate 6mm, 10mm with gasket, and 12mm wet set glazing
- Glazing vinyl available in black colour
- Designed and engineered to meet or exceed building codes

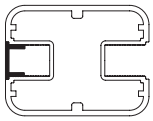

End Posts

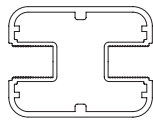

Centre Posts



90 Degree Corner Posts

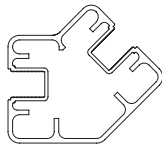

135 Degree Posts

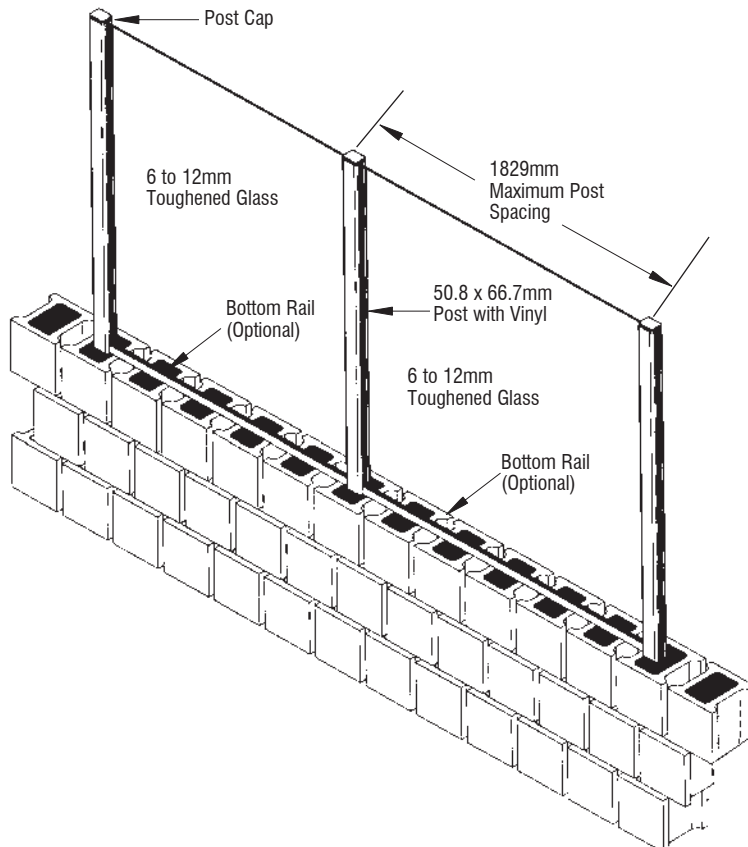
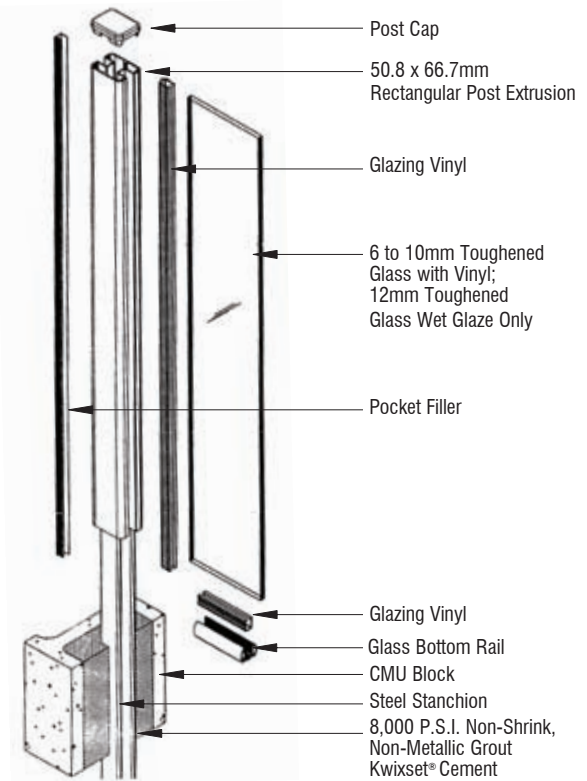



# CRL AWS Rectangular Post Caps

## CODE

## DESCRIPTION

PC1SXX

Caps for 180 Degree Centre Posts or End Posts

- Ready to install
- Attaches to post using CRL's 95CBL silicone



PC135SXX

Caps for 135 Degree Posts

- Ready to install
- Attaches to post using CRL's 95CBL silicone

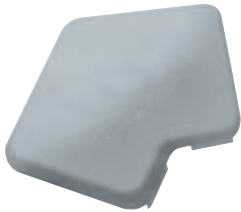

PC9SXX

Caps for 90 Degree Corner Posts

- Ready to install
- Attaches to post using CRL's 95CBL silicone

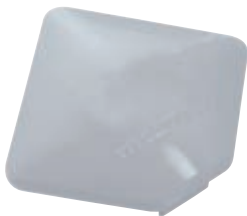

# CRL AWS Round 180 Degree Posts & Kits

## CODE

## DESCRIPTION

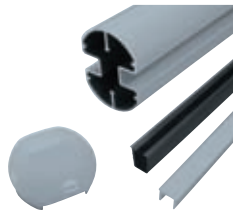

**R36CKXX** 914mm  
**R48CKXX** 1219mm  
**R60CKXX** 1524mm  
**R72CKXX** 1829mm  
  
**R36EKXX** 914mm  
**R48EKXX** 1219mm  
**R60EKXX** 1524mm  
**R72EKXX** 1829mm

### CRL AWS 76.2mm Diameter Round 180 Degree Centre or End Post Kits

- Standard kits include post, top cap, and vinyl
- Custom colours available upon request
- Accommodates 6 to 10mm glass dry glazed with vinyl
- Accommodates 12mm glass wet glazed

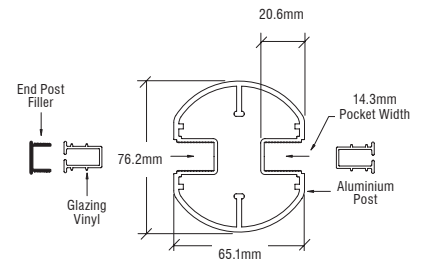

**RP194XX** 6.12m

### CRL AWS 76.2mm Diameter Round 180 Degree Centre or End Post Only

- Low maintenance
- Special coating to prevent corrosion
- 6.12m stock length so you can cut custom heights
- Custom colours also available

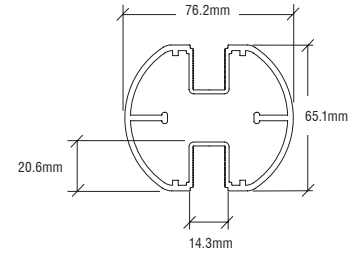

# CRL AWS Round 90 Degree Corner Posts & Kits

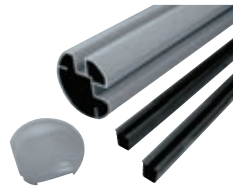

**R36CRKXX** 914mm  
**R48CRKXX** 1219mm  
**R60CRKXX** 1524mm  
**R72CRKXX** 1829mm

### CRL AWS 76.2mm Diameter Round 90 Degree Corner Post Kits

- Standard kits include post, top cap, and vinyl
- Custom colours available upon request
- Accommodates 6 to 10mm glass dry glazed with vinyl
- Accommodates 12mm glass wet glazed

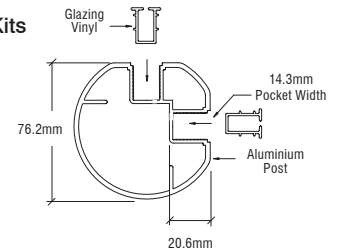

**RP9194XX** 6.12m

### CRL AWS 76.2mm Diameter Round 90 Degree Corner Post Only

- Ready to install
- Low maintenance
- Special coating to prevent corrosion
- 6.12m stock length so you can cut custom heights
- Custom colours also available

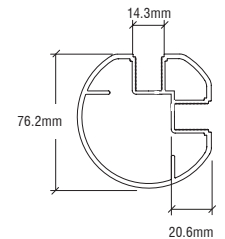

# CRL AWS Round 135 Degree Corner Posts & Kits



**R365KXX** 914mm  
**R485KXX** 1219mm  
**R605KXX** 1524mm  
**R725KXX** 1829mm

### CRL AWS 76.2mm Diameter Round 135 Degree Post Kits

- Standard kits include post, top cap, and vinyl
- Custom colours available upon request
- Accommodates 6 to 10mm glass dry glazed with vinyl
- Accommodates 12mm glass wet glazed

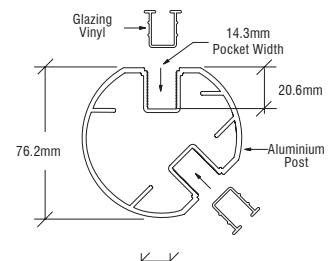

**RP5241** 6.12m

### CRL AWS 76.2mm Diameter Round 135 Degree Post Only

- Ready to install
- Low maintenance
- Special coating to prevent corrosion
- 6.12m stock length so you can cut custom heights
- Custom colours also available

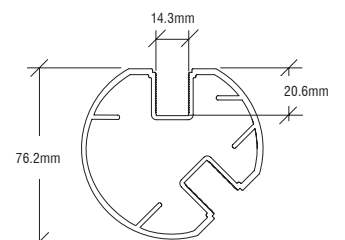

## CRL AWS Round Aluminium Windscreen System



NOTE: Not for use as a guard rail.



- 76.2mm diameter aluminium windscreen system for pools, balconies, fencing, steps, slopes, and many other options
- Low maintenance with all components specially coated to prevent corrosion
- Will accommodate 6mm, 10mm using gasket and 12mm wet set glazing
- 914mm, 1219mm, 1524mm, and 1829mm standard heights. 6.12m stock lengths available
- Glazing vinyl available in black colour
- Designed and engineered to meet or exceed building codes

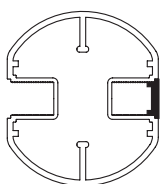
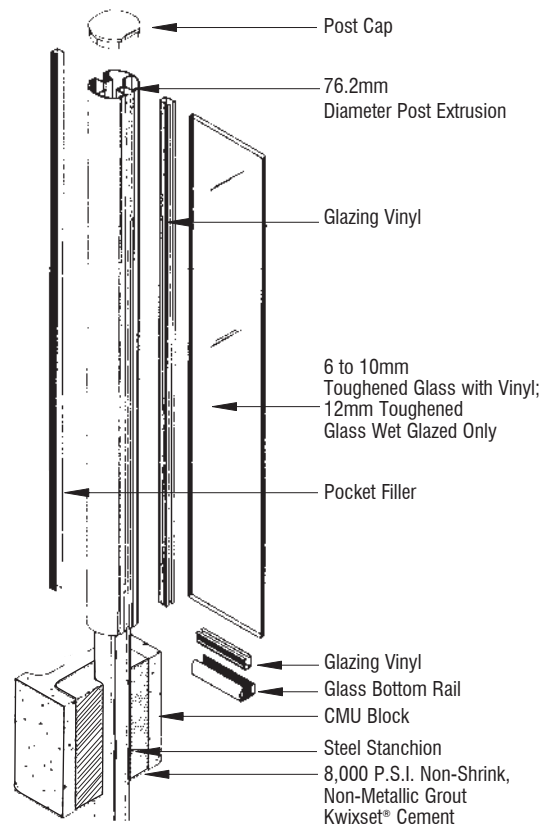
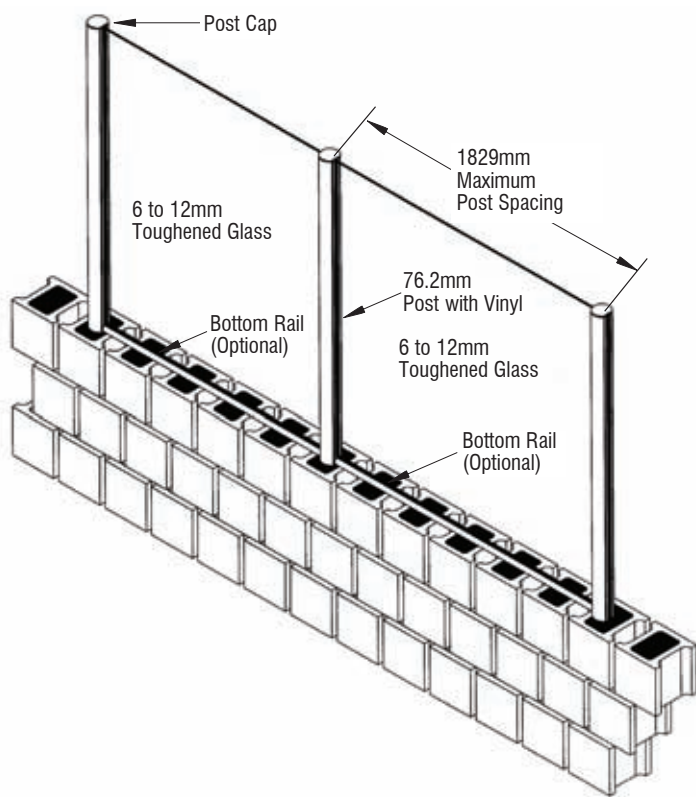

End Posts

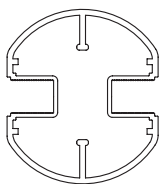

Centre Posts

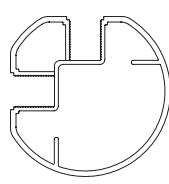







90 Degree Posts

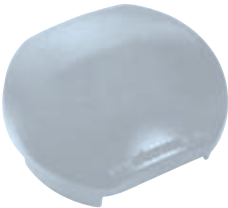

135 Degree Posts



# CRL AWS Round Post Caps

|                                                                                     | CODE     | DESCRIPTION                                                         |                                                                                       |
|-------------------------------------------------------------------------------------|----------|---------------------------------------------------------------------|---------------------------------------------------------------------------------------|
|    | PC1RXX   | Caps for 180 Degree Centre Posts or End Posts<br>• Ready to install |    |
|   | PC135RXX | Caps for 135 Degree Posts<br>• Ready to install                     |   |
|  | PC9RXX   | Caps for 90 Degree Corner Posts<br>• Ready to install               |  |

| CODE | DESCRIPTION |
|------|-------------|
|------|-------------|



**PST1** 457mm height.  
Grade 50 steel.  
Posts up to 914mm high.  
3.2mm thick

**PST2** 457mm height.  
Grade 50 steel.  
Posts up to 1219mm high.  
6.3mm thick.

**PST3** 762mm height.  
Grade 50 steel.  
Posts up to 1829mm high  
6.3mm thick

**PST4** 762mm height.  
304 Grade stainless steel.  
Posts up to 1829mm high  
3.2mm thick

**PST5** 1067mm height.  
Grade 50 steel.  
Call for post height info.  
6.3mm thick

**CRL AWS Core Mount Stanchions**

- Galvanized to prevent corrosion
- Available in four different sizes for round or rectangular windscreen posts
- Available in stainless steel for coastal installations
- Fits all of our rectangular or round aluminium posts

**Core Mount Installation for a Concrete Slab**

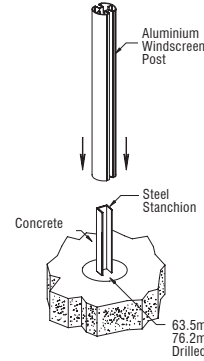

**Core Mount Installation for CMU Block Walls**

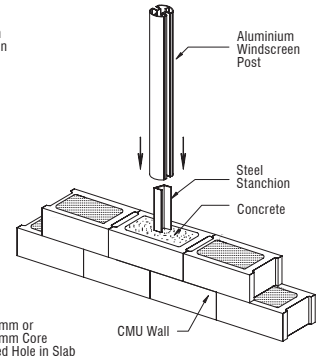

## CRL AWS Welded Steel Surface Mount Stanchions

- Mounting bases available in seven standard colours, plus unfinished chromate to match AWS posts
- 90,135, and 180 degree bases are designed for concrete or steel installations
- Attaches to the post using our 95CBL silicone
- Galvanized and powder coated to prevent corrosion

**Steel Stanchions for Post Heights up to 610mm (Stanchion height 305mm)**

|        |                                       |
|--------|---------------------------------------|
| PSB1A  | For 180° Round/Rectangular Centre/End |
| PSB2A  | For 90° Round                         |
| PSB3A  | For 90° Rectangular Posts             |
| PSB4A  | For 135° Round                        |
| PSB5A  | For 135° Rectangular Posts            |
| BPG1BL | Gasket                                |

**Steel Stanchions for Post Heights up to 1219mm (Stanchion height 762mm)**

|        |                                       |
|--------|---------------------------------------|
| PSB1B  | For 180° Round/Rectangular Centre/End |
| PSB2B  | For 90° Round                         |
| PSB3B  | For 90° Rectangular Posts             |
| PSB4B  | For 135° Round                        |
| PSB5B  | For 135° Rectangular Posts            |
| BPG1BL | Gasket                                |

**Steel Stanchions for Post Heights up to 1829mm (Stanchion height 762mm)**

|        |                                       |
|--------|---------------------------------------|
| PSB1C  | For 180° Round/Rectangular Centre/End |
| PSB2C  | For 90° Round                         |
| PSB3C  | For 90° Rectangular Posts             |
| PSB4C  | For 135° Round                        |
| PSB5C  | For 135° Rectangular Posts            |
| BPG2BL | Gasket                                |

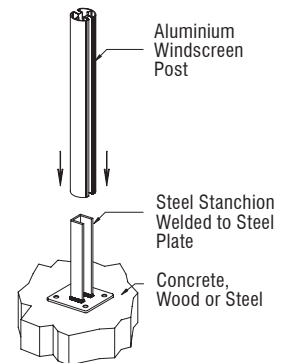

# CRL AWS Post Pocket Fillers & Vinyls

## CODE

## DESCRIPTION

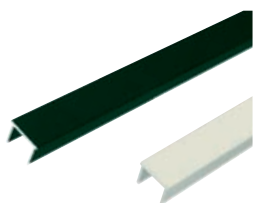

PF36 914mm

PF48 1219mm

PF60 1524mm

PF72 1829mm

PF194 6.12m

### CRL AWS Windscreen Post Pocket Fillers

- Ready to snap into glass pocket
- Low maintenance
- Special coating to prevent corrosion

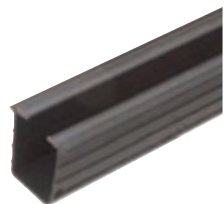
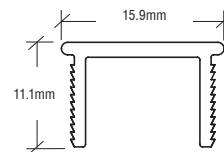

GV36BL 914mm

GV48BL 1219mm

GV60BL 1524mm

GV72BL 1829mm

GV120BL 3.66m

### CRL AWS Rigid Glazing Vinyl

- Black colour rigid push-in glazing vinyl for use with aluminium windscreen posts and bottom rails
- Designed to accommodate 6 to 10mm toughened glazing

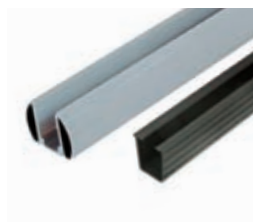
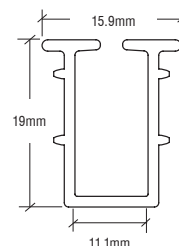

BR36K 914mm

BR48K 1219mm

BR60K 1524mm

BR72K 1829mm

BR194 3.66m

### CRL AWS Bottom Rail Kits With Rigid Glazing Vinyl

- Low maintenance
- Special coating to prevent corrosion
- Designed to accommodate 6 and 10mm toughened glazing

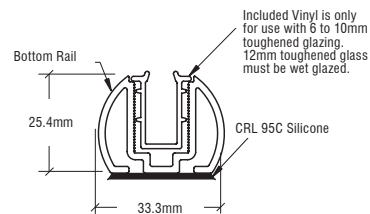

**For Glazing Vinyl please see P12**

# CRL AWS Glass Rails & Fillers

BRGLSXX

### CRL Intermediate Bottom Glass Rail

- Bottom rail designed to accommodate 6 to 12mm toughened glass
- 6mm and 10mm using gasket. 12mm using wet glaze

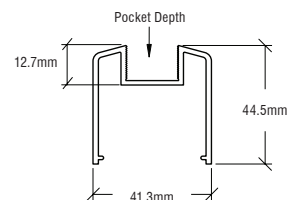

BRF241XX

### CRL Standard Bottom Rail Filler

- Snaps in to conceal the underside of bottom rails and create a flush look

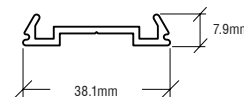

RCB2 25.4mm

RCB212 305mm

RCB2241 6.12m

### CRL Rail Connecting Blocks

- For use when installing bottom rails
- Three standard lengths available

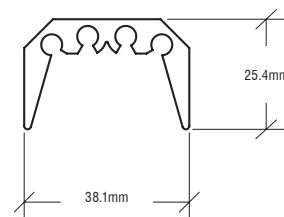





**Install glass balustrades  
with ease...**

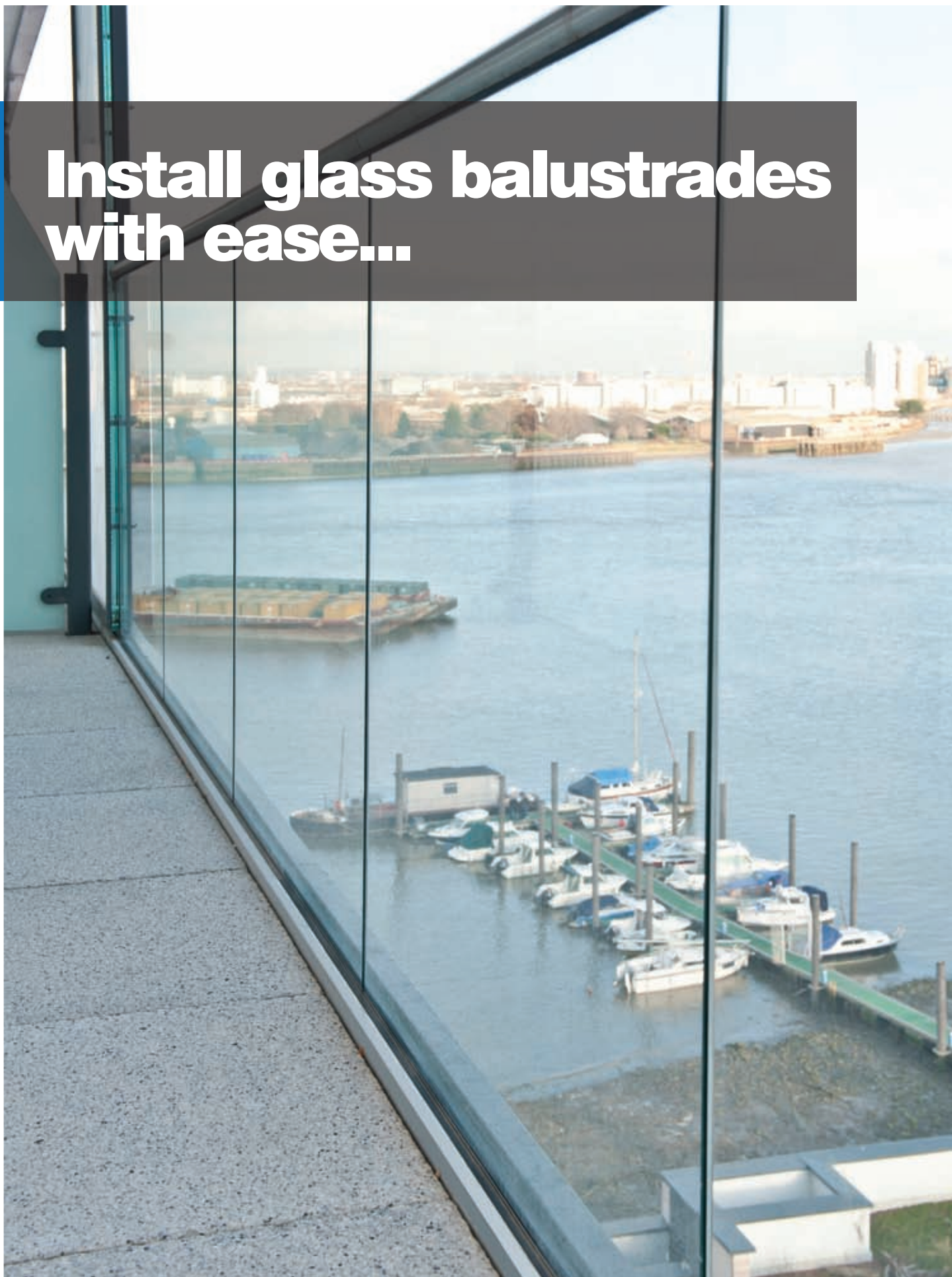

- 50% faster to install than traditional alternatives
- Dry glaze system, no need for cement
- Tested to meet the strictest building code requirements BS6180:1999, BS6399-1:1996 and AbZ
- The product is completely unique because it uses a horizontal TAPER-LOC® design, which allows the system to be adjusted, dismantled and re-set
- Ideal for replacing scratched and broken panels in existing applications

For more information visit [taper-loc.co.uk](http://taper-loc.co.uk)

**NOTE:** The System includes an Installation/Removal Tool and CRL TAPER-LOC® Tapers for 12mm, 15mm, and 19mm toughened monolithic glass applications, and 13.52mm, 17.52mm, 21.52mm, and 25.52mm laminated toughened glass. Unique because they use a horizontal taper lock design, TAPER-LOC® Tapers are simply installed with CRL's exclusive TLK9/TLK12 Installation/Removal Tool.

TAPER-LOC® U.S. Patent Number 8,122,654



Ready...

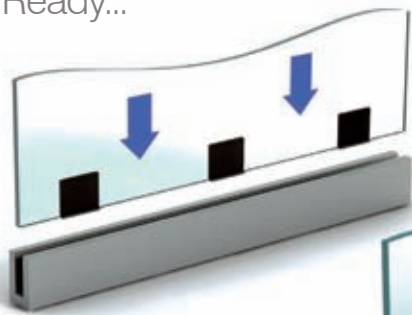

Set...

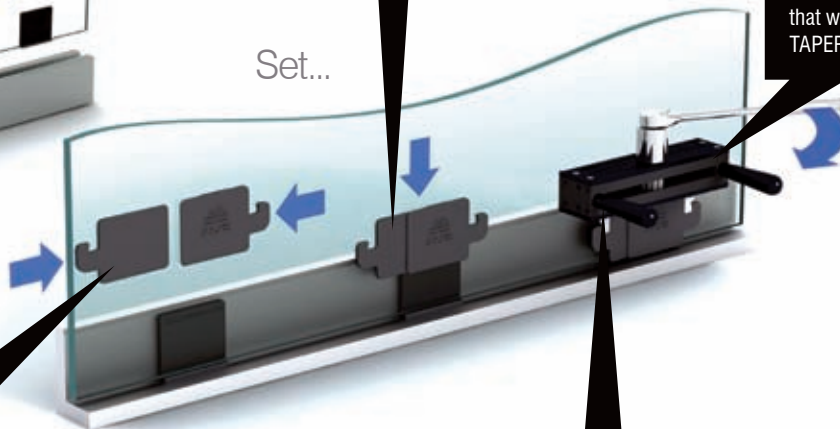

TAPER-LOC® Tapers insert into the Base Shoe every 350mm Centre-to-Centre.

**CAT. NO. TL5X10**  
For Monolithic Toughened Applications  
**CAT. NO. LTL10X OR LTL96X**  
For Laminated Toughened Applications

**CAT. NO. TLK9/TLK12**  
Installation/Removal Tool  
With Integrated Torque Wrench  
that works with all of CRL's  
TAPER-LOC® Tapers.

The TAPER-LOC® Installation/Removal Tool compresses the Tapers together to lock the glass in place.

Done.

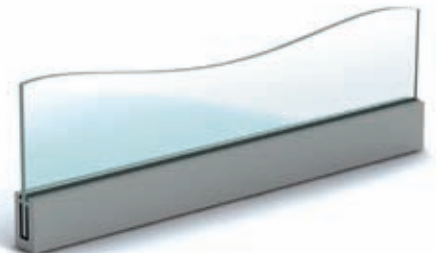

There's even more in our specialist TAPER-LOC® Catalogue. Order your free copy at [Taper-Loc.co.uk](http://Taper-Loc.co.uk)

**TAPER-LOC®**  
DRY GLAZE RAILING SYSTEM



- Complete with mounting plate
- For use with 12 and 19mm monolithic toughened glass or 13.5 and 21.5mm laminated toughened glass
- Brushed or polished 316 grade stainless finishes available
- Designed for steel, wood, and concrete substrates

CRL's heavy-duty, point supported Glass Rail Standoff Fittings gives the installer more adjustment during installation for those tricky job site mounting conditions. The steel back plate can be fastened directly to steel, concrete, or wood substrates and shimmed as required with blocking.



## CODE

## DESCRIPTION

RS0B20BS

**CRL Glass Rail Stand-off Fittings Standard 51mm Diameter Caps**

RS0B20PS

- For use with 12 or 19mm monolithic toughened glass.
- Also for use with 13.5 or 21.5mm laminated toughened glass.
- Two 19mm diameter holes per fitting
- Full engineering data available at [crlaurence.co.uk](http://crlaurence.co.uk)



RS0B25BS

**CRL Glass Rail Stand-off Fittings Standard 60mm Diameter Caps**

RS0B25PS

- Ready to install
- Low maintenance with special coating to prevent corrosion
- Four standard post heights, plus a stock length so you can cut custom heights
- Custom colours also available
- Seven attractive colours, plus unfinished chromate available from stock. For details visit [crlaurence.co.uk](http://crlaurence.co.uk)







- For use with 12 and 19mm monolithic toughened glass or 13.5 and 21.5mm laminated toughened glass
- Brushed or polished 316 grade stainless finishes available
- Designed for steel, wood, and concrete substrates
- Standard 51mm caps

These heavy-duty Rail Standoffs are designed for glass handrail or guardrail applications standard. The Standoff Fittings have a 44mm standard projection from the installed attachment point. Custom lengths and diameters are also available.



| CODE | DESCRIPTION |
|------|-------------|
|------|-------------|

- |            |                                                                                                                                                                                                                                                                                                                                                                                                          |
|------------|----------------------------------------------------------------------------------------------------------------------------------------------------------------------------------------------------------------------------------------------------------------------------------------------------------------------------------------------------------------------------------------------------------|
| RS0B2134BS | <b>CRL Glass Rail Stand-off Base and Cap Standard 51mm Diameter Caps</b> <ul style="list-style-type: none"> <li>• For Use With 12 or 19mm monolithic toughened glass</li> <li>• Also for use with 13.5 or 21.5mm laminated toughened glass</li> <li>• One 19mm diameter hole per fitting</li> <li>• Full engineering data available at <a href="http://crlaurence.co.uk">crlaurence.co.uk</a></li> </ul> |
| RS0B2134PS |                                                                                                                                                                                                                                                                                                                                                                                                          |



- |            |                                                                                                                                                                                                                                                                                                                                           |
|------------|-------------------------------------------------------------------------------------------------------------------------------------------------------------------------------------------------------------------------------------------------------------------------------------------------------------------------------------------|
| RS0B2135BS | <b>CRL Brushed Stainless Point Supported Standoff Base and Domed Cap</b> <ul style="list-style-type: none"> <li>• For use with 12 and 19mm monolithic toughened glass or 13.5 and 21.5mm laminated toughened glass using DuPont™ SentryGlas® Interlayers</li> <li>• Brushed or Polished 316 grade stainless finishes available</li> </ul> |
| RS0B2135PS |                                                                                                                                                                                                                                                                                                                                           |





# CRL Frameless Windscreen Clamp System



- Also known as spigots
- Gives an 'all-glass' frameless look
- Great for pool fencing, balcony, and deck applications
- Available in two standard architectural finishes
- 316 alloy and duplex 2205 marine grade finishes
- Designed for 12mm toughened glazing

Our Frameless Windscreen Clamps, which are also known as spigots, provide a break from the wind using an almost invisible "frameless" look. No vertical posts are used between the panels of glass; they are solely supported from the bottom by these high strength stainless steel clamps.



| CODE | DESCRIPTION |
|------|-------------|
|------|-------------|



|                                    |                                                                                           |
|------------------------------------|-------------------------------------------------------------------------------------------|
| <b>AFWC1</b><br>Brushed Stainless  | <b>CRL One-Piece Core Mount Clamp</b><br>• 30mm rod easily inserts into core-drilled hole |
| <b>AFWC6</b><br>Polished Stainless |                                                                                           |

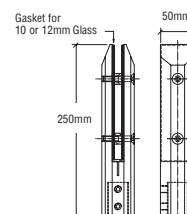

|                                        |                                                                                              |
|----------------------------------------|----------------------------------------------------------------------------------------------|
| <b>AFWC1SBS</b><br>Brushed Stainless   | <b>One-Piece Bevelled Surface Mount Clamp</b><br>• New, easy to install surface mount design |
| <b>AFWCC1SPS</b><br>Polished Stainless |                                                                                              |

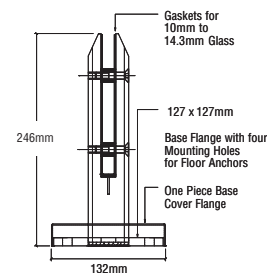

|                                    |                                                                              |
|------------------------------------|------------------------------------------------------------------------------|
| <b>AFWC2</b><br>Polished Stainless | <b>Two-Piece Side Mount Clamp</b><br>• Mounts on face of wall or planter box |
| <b>AFWC7</b><br>Brushed Stainless  |                                                                              |

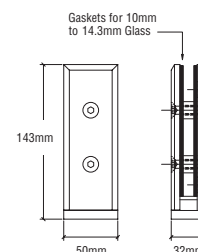

**CODE**

**DESCRIPTION**



**AFWC3**  
Brushed Stainless  
**AFWC8**  
Polished Stainless

**CRL Three-Piece Core Mount Clamp**  
• 16mm rod easily inserts into core-drilled hole

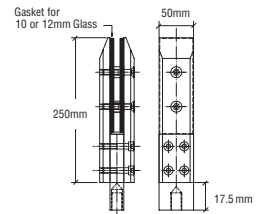

**AFWC4**  
Brushed Stainless

**CRL Two-Piece Core Mount Round Clamp**  
• Duplex 2205 grade stainless has higher corrosive resistance

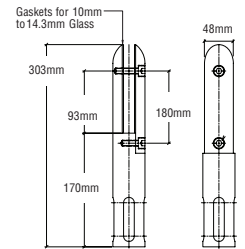

**DFWC3**  
Brushed Stainless

**CRL Three-Piece Core Mount Clamp**  
• Duplex 2205 grade stainless has higher corrosive resistance

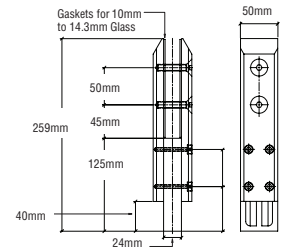

**AFWC4SBS**  
Brushed Stainless  
**AFWC4SPS**  
Polished Stainless

**CRL One-Piece Low Profile Surface Mount Clamp**  
• New, easy to install surface mount design

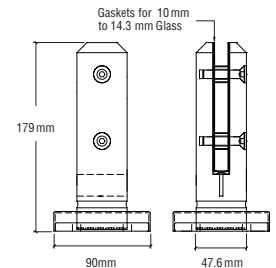

**AFWC1G**  
Fits AFWC1  
**AFWC6G**  
Fits AFWC6  
**AFWC3G**  
Fits AFWC3  
**AFWC8G**  
Fits AFWC8

**CRL Garnish Rings for Windscreen Clamps**  
• Garnish rings easily slip over the frameless windscreen clamp

**CRL AWS Low Profile Cap Railing Accessories**

Low Profile Cap Rail



Corners



End Caps



Contact Cement



Call FREE on 00 800 0421 6144  
Fax FREE on 00 800 0262 3299



**Manchester**

Charles Babbage Avenue  
Kingsway Business Park,  
Rochdale, OL16 4NW, England  
Tel: +44 (0) 1706 863 600  
Fax: +44 (0) 1706 869 860  
[www.crlaurence.co.uk](http://www.crlaurence.co.uk)



**Stuttgart**

Boschstrasse 7  
D-74360 Ilfsfeld  
Germany  
Tel: +49 (0) 7062 915 93 15  
Fax: +49 (0) 7062 915 93 16  
[www.crlaurence.de](http://www.crlaurence.de)



**Copenhagen**

Stamholmen 70 Unit B,  
DK-2650 Hvidovre  
Denmark  
Tel: +45 36 72 09 00  
Fax: +45 36 70 33 35  
[www.crlaurence.dk](http://www.crlaurence.dk)



**France**

Boschstrasse 7  
D-74360 Ilfsfeld  
Germany  
Tel: +49 (0) 7062 915 93 15  
Fax: +49 (0) 7062 915 93 16  
[www.crlaurence.fr](http://www.crlaurence.fr)

**CRL**<sup>®</sup>  
[crlaurence.co.uk](http://crlaurence.co.uk)



View Our Full Range of  
Architectural Railing Systems...

Our EUHR11 Architectural Balustrade and Railing  
Systems Catalogue

- Glass Railings/Balustrades
- TAPER-LOC<sup>®</sup> Railing System
- Swinging Gate Systems
- Post Railing Systems
- Welded Railing Systems
- Hand Railing Systems
- Aluminium Railing Systems
- Glass Walls/Windcreens
- Tools/Accessories

You may also be interested in...

EUAH11 Architectural Hardware  
'All Glass' Entrance Systems Catalogue

- Architectural Metals
- Door and Sidelite Rails
- Door Closers
- Centre Locks
- Glass Clamps
- Headers and Channels
- Ladder Pulls
- Locking Hardware
- Door Closers and Hinges
- Patch Hardware
- Pivot Door Systems
- Push/Pull Handles
- Sliding and Stacking Glass Door Systems
- Spider Fittings
- Standoff Systems

Catalogues are available to download  
or view online at [crlaurence.co.uk](http://crlaurence.co.uk)  
or [crlaurence.de](http://crlaurence.de)

# Shower Door Hardware

CRL - the world's largest supplier  
of Frameless Shower products

Create your perfect bathroom with  
our extensive range of Shower  
Hardware and accessories.

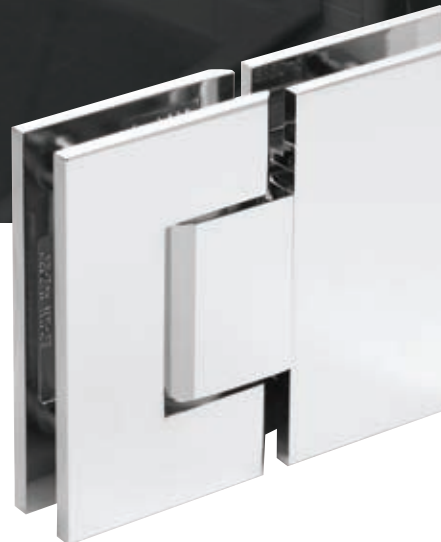





# Shower Door Hardware

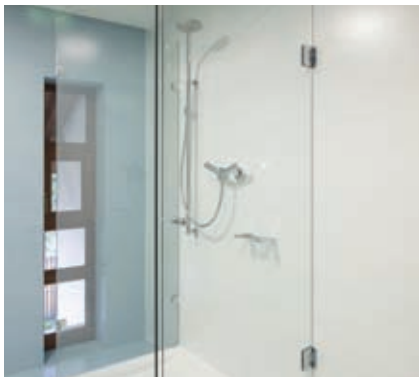

Inside this brochure you will find a selection of our best selling shower door products taken from our full, industry leading range.

From complete systems such as the popular CRL Hydroslide Sliding Shower Door Kit and the new CRL Serenity Series Sliding Door System, to accessories such as Hinges, Handles, Door Knobs, Channels and Clamps, CRL offers the complete package of quality hardware and accessories.

CRL offers the largest variety of Frameless Shower Door Hardware in the glass industry.

Hinges **04-15**

Sliding Shower Door Kits **16-18**

U-Channels **19**

Glass Door Clamps **22-24**

Pull Handles & Knobs **25**

Support Bars & Headers **28-32**

Glass Door Locks **33**

Towel Bars **34-35**

Shower Door Seals **36-37**

Shower Hardware & Accessories **38-39**

Colour Range **Back Cover Flap**

**CRL**  
crlaurence.co.uk

For more information call FREE on

**00 800 0421 6144**

e: [CRL@crlaurence.co.uk](mailto:CRL@crlaurence.co.uk) f: 00 800 0262 3299



## Specifications

**Glass Thickness:** 8mm to 12mm Toughened Safety Glass

**Special Feature:** Offers choice of Standard Model factory set at standard closing position 0°, or 5° Pre-Set Model for tighter closure into shower interior

**Construction:** Solid Brass

**Hinge Swings:** 90° in and 90° out

**Closing Type:** Self-centring when within 15° of closed position.

**Cut-Out Required**

**Includes:** Gaskets, Screws, and Glass Fabrication Dimensions

**Standard:** DIN EN14428

**For maximum weight and door width capacities please see [crlaurence.co.uk](http://crlaurence.co.uk)**

## Colours

Chrome version shown below. 20 attractive colours available. For details please see the flip out chart at the rear of this brochure or visit [crlaurence.co.uk](http://crlaurence.co.uk)



| View | Cat. No. / Description                                                                                                                                                                                                                       | View | Cat. No. / Description                                                                                                                                                                                                                |
|------|----------------------------------------------------------------------------------------------------------------------------------------------------------------------------------------------------------------------------------------------|------|---------------------------------------------------------------------------------------------------------------------------------------------------------------------------------------------------------------------------------------|
|      | <p><b>Cat. No. GEN037XX</b><br/>Wall Mount Full Back Plate Standard Model (Factory set for standard closing position)</p> <p><b>Cat. No. GEN537XX</b><br/>5° Pre-Set Model<br/>(Factory set for 5° tighter closure into shower interior)</p> |      | <p><b>Cat. No. GEN180XX</b><br/>180° Glass-to-Glass Standard Model<br/>(Factory set for standard closing position)</p> <p><b>Cat. No. GEN580XX</b><br/>5° Pre-Set Model (Factory set for 5° tighter closure into shower interior)</p> |
|      | <p><b>Cat. No. GEN074XX</b><br/>Wall Mount Short Back Plate Standard Model</p> <p><b>Cat. No. GEN574XX</b><br/>5° Pre-Set Model<br/>(Factory set for 5° tighter closure into shower interior)</p>                                            |      | <p><b>Cat. No. GEN045XX</b><br/>135° Glass-to-Glass Standard Model<br/>(Factory set for standard closing position)</p> <p><b>Cat. No. GEN545XX</b><br/>5° Pre-Set Model (Factory set for 5° tighter closure into shower interior)</p> |
|      | <p><b>Cat. No. GEN044XX</b><br/>Wall Mount Offset Back Plate<br/>(Factory set for standard closing position)</p> <p><b>Cat. No. GEN544XX</b><br/>Wall Mount Offset Back Plate<br/>(Factory set for standard closing position)</p>            |      | <p><b>Cat. No. GEN092XX</b><br/>90° Glass-to-Glass</p>                                                                                                                                                                                |

## Pivot Pin

See [crlaurence.co.uk](http://crlaurence.co.uk) for more Pivot Pin information

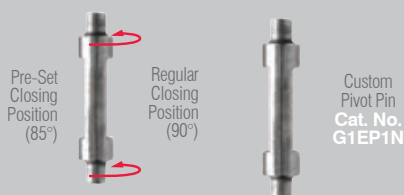

Custom Pivot Pin  
Cat. No. G1EP1N



### Specifications

**Glass Thickness:** 8mm to 12mm Toughened Safety Glass

**Special Feature:** Adjustable to Any Angle Up to 90° Without Having to Take Door Down

**Construction:** Solid Brass

**Hinge Swings:** 90° in and 90° out (at factory set position)

**Closing Type:** Self-centring when within 15° of closed position

**Cut-Out Required**

**Includes:** Gaskets, Screws, and Glass Fabrication Dimensions

**Standard:** DIN EN14428

**NOTE:** Door Glass width may require alteration from standard clearance deductions when adjusting angles. Call for details.

**For maximum weight and door width capacities please see [crlaurence.co.uk](http://crlaurence.co.uk)**

### Colours

Chrome version shown below. 20 attractive colours available. For details please see the flip out chart at the rear of this brochure or visit [crlaurence.co.uk](http://crlaurence.co.uk)



| Front View | Rear View | Cat No. / Description                                                          |
|------------|-----------|--------------------------------------------------------------------------------|
|            |           | <b>Cat. No. GEN337XX</b><br>Adjustable Wall Mount Full Back Plate<br>          |
|            |           | <b>Cat. No. GEN344XX</b><br>Adjustable Chrome Wall Mount Offset Back Plate<br> |
|            |           | <b>Cat. No. GEN345XX</b><br>Adjustable 135° Glass-to-Glass<br>                 |
|            |           | <b>Cat. No. GEN380XX</b><br>Adjustable 180° Glass-to-Glass<br>                 |

## CRL Jamb Mounted Hinge Kits

Our Jamb Mounted Hinge Kits let you provide an 'all-glass' look shower door in an easy-to-install configuration. Water leakage around the door is minimised with the use of extruded aluminum jamba with vinyl for both the hinge and strike sides, and a clear vinyl sweep for the bottom. Kits come in your choice of three of our most popular finishes, with glass cut-out templates and installation instructions enclosed.

**STANDARD HINGE KITS**  
 For 8mm to 12mm Toughened Safety Glass.

|                                 |            |
|---------------------------------|------------|
| 1.83m High Geneva Series Kits   | GEN03372XX |
| 1.98m High Geneva Series Kits   | GEN03378XX |
| 1.83m High Pinnacle Series Kits | P1N03372XX |
| 1.98m High Pinnacle Series Kits | P1N03378XX |

**HEAVY DUTY HINGE KITS**  
 For 10mm to 12mm Toughened Safety Glass.

|                               |            |
|-------------------------------|------------|
| 1.83m High Vienna Series Kits | V1E03372XX |
|-------------------------------|------------|





**Suitable for heavier glass**

### Specifications

**Glass Thickness:** 10mm to 12mm  
Toughened Safety Glass

**Construction:** Solid Brass

**Hinge Swings:** 90° in and 90° out

**Closing Type:** Self-centring when within 15° of closed position

### Cut-Out Required

**Includes:** Gaskets, Screws, and Glass Fabrication Dimensions







**Standard:** DIN EN14428

**For maximum weight and door width capacities please see [crlaurence.co.uk](http://crlaurence.co.uk)**

### Colours

Chrome version shown below. 20 attractive colours available. For details please see the flip out chart at the rear of this brochure or visit [crlaurence.co.uk](http://crlaurence.co.uk)

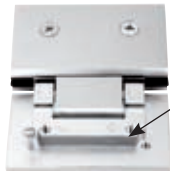
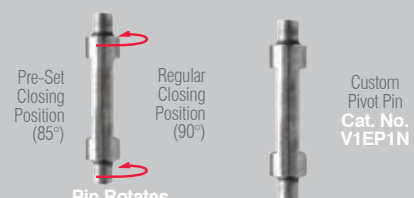

| View                                                                                                                                                                                                                  | Cat No. / Description                                                                                                                                                                                                               | View                                                                                                                                                                                                                                                                                                                                                   | Cat No. / Description                                                                                                                                                                                                   |
|-----------------------------------------------------------------------------------------------------------------------------------------------------------------------------------------------------------------------|-------------------------------------------------------------------------------------------------------------------------------------------------------------------------------------------------------------------------------------|--------------------------------------------------------------------------------------------------------------------------------------------------------------------------------------------------------------------------------------------------------------------------------------------------------------------------------------------------------|-------------------------------------------------------------------------------------------------------------------------------------------------------------------------------------------------------------------------|
|                                                                                                                                     | <b>Cat. No. V1E037XX</b><br>Wall Mount Full Back Plate<br>Standard Model (Factory set for standard closing position)<br><b>Cat. No. V1E537XX</b><br>5° Pre-Set Model<br>(Factory set for 5° tighter closure into shower interior)   |                                                                                                                                                                                                                                                                     | <b>Cat. No. V1E074XX</b><br>Wall Mount Short Back Plate                                                                                                                                                                 |
|                                                                                                                                     | <b>Cat. No. V1E044XX</b><br>Wall Mount Offset Back Plate Standard Model<br>(Factory set for standard closing position)<br><b>Cat. No. V1E544XX</b><br>5° Pre-Set Model<br>(Factory set for 5° tighter closure into shower interior) |                                                                                                                                                                                                                                                                     | <b>Cat. No. V1E180XX</b><br>180° Glass-to-Glass Standard Model<br>(Factory set for standard closing position)<br><b>Cat. No. V1E580XX</b><br>5° Pre-Set Model (Factory set for 5° tighter closure into shower interior) |
|                                                                                                                                     | <b>Cat. No. V1E045XX</b><br>135° Glass-to-Glass                                                                                                                                                                                     |                                                                                                                                                                                                                                                                     | <b>Cat. No. V1E092XX</b><br>90° Glass-to-Glass                                                                                                                                                                          |
|  <p>Internal View of Vienna Hinge</p> <p>Pin In Place (For "Mouse Ears" Cut-Out)</p> <p>Pin Removed (For Square Corner Cut-Out)</p> |                                                                                                                                                                                                                                     | <p><b>Pivot Pin</b><br/>See <a href="http://crlaurence.co.uk">crlaurence.co.uk</a> for more Pivot Pin information</p>  <p>Pre-Set Closing Position (85°)</p> <p>Regular Closing Position (90°)</p> <p>Pin Rotates</p> <p>Custom Pivot Pin<br/>Cat. No. V1EP1N</p> |                                                                                                                                                                                                                         |



### Specifications

**Glass Thickness:** 10mm to 12mm Toughened Safety Glass

**Special Feature:** Adjustable to Any Angle Up to 90 Degrees Without Having to Take Door Down

**Construction:** Solid Brass

**Hinge Swings:** 90° in and 90° out (at factory set position)

**Closing Type:** Self-centring when within 15° of closed position

### Cut-Out Required

**Includes:** Gaskets, Screws, and Glass Fabrication Dimensions

**Standard:** DIN EN14428

**NOTE:** Door Glass Width May Require Alteration From Standard Clearance Deductions When Adjusting Angles. Call for Details.

**For maximum weight and door width capacities please see [crlaurence.co.uk](http://crlaurence.co.uk)**

### Colours

Chrome version shown below. 20 attractive colours available. For details please see the flip out chart at the rear of this brochure or visit [crlaurence.co.uk](http://crlaurence.co.uk)



Front View

Rear View

Cat No. / Description



Allen Adjustment Screws

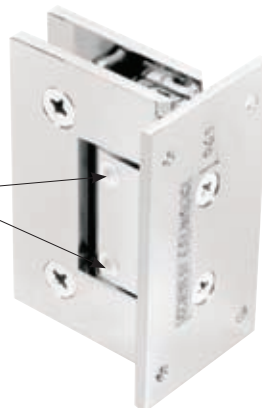

**Cat. No. V1E337XX**  
Adjustable Wall Mount Full Back Plate

adjustable



Allen Adjustment Screws



**Cat. No. V1E380XX**  
Adjustable 180° Glass-to-Glass  
Adjustable Hinges open to 90°, only adjustable to 45°

adjustable



## Specifications

**Glass Thickness:** 8mm to 12mm Toughened Safety Glass

**Special Feature:** Wall Mount Hinges and 180° Glass-to-Glass Hinge offer a choice of a Standard Model, factory set at standard closing position (0°), or a 5° Pre-Set Model for tighter closure into shower interior

**Construction:** Solid Brass

**Hinge Swings:** 90° in and 90° out

**Closing Type:** Self-centring when within 15° of closed position

**Cut-Out Required**

**Includes:** Gaskets, Screws, and Glass Fabrication Dimensions







**Standard:** DIN EN14428

**For maximum weight and door width capacities please see [crlaurence.co.uk](http://crlaurence.co.uk)**

## Colours

Chrome version shown below. 20 attractive colours available. For details please see the flip out chart at the rear of this brochure or visit [crlaurence.co.uk](http://crlaurence.co.uk)



| View                                                                                | Cat. No. / Description                                                                                                                                                                                                                         | View                                                                                | Cat. No. / Description                                                                                                                                                                                                            |
|-------------------------------------------------------------------------------------|------------------------------------------------------------------------------------------------------------------------------------------------------------------------------------------------------------------------------------------------|-------------------------------------------------------------------------------------|-----------------------------------------------------------------------------------------------------------------------------------------------------------------------------------------------------------------------------------|
|  | <p><b>Cat. No. P1N037XX</b><br/>Wall Mount Full Back Plate Standard Model (Factory set for standard closing position)</p> <p><b>Cat. No. P1N537XX</b><br/>5° Pre-Set Model<br/>(Factory set for 5° tighter closure into shower interior)</p>   |  | <p><b>Cat. No. P1N180XX</b><br/>180° Glass-to-Glass Standard Model (Factory set for standard closing position)</p> <p><b>Cat. No. P1N580XX</b><br/>5° Pre-Set Model (Factory set for 5° tighter closure into shower interior)</p> |
|  | <p><b>Cat. No. P1N074XX</b><br/>Wall Mount Short Back Plate Standard Model (Factory set for standard closing position)</p> <p><b>Cat. No. P1N574XX</b><br/>5° Pre-Set Model<br/>(Factory set for 5° tighter closure into shower interior)</p>  |  | <p><b>Cat. No. P1N045XX</b><br/>135° Glass-to-Glass</p>                                                                                                                                                                           |
|  | <p><b>Cat. No. P1N044XX</b><br/>Wall Mount Offset Back Plate Standard Model<br/>(Factory set for standard closing position)</p> <p><b>Cat. No. P1N544XX</b><br/>5° Pre-Set Model (Factory set for 5° tighter closure into shower interior)</p> |  | <p><b>Cat. No. P1N092XX</b><br/>90° Glass-to-Glass</p>                                                                                                                                                                            |

## Pivot Pin

See [crlaurence.co.uk](http://crlaurence.co.uk) for more Pivot Pin information

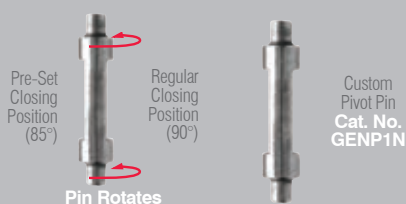



### Specifications

**Glass Thickness:** 8mm to 12mm Toughened Safety Glass

**Special Feature:** Adjustable to any angle up to 90° without having to take door down

**Construction:** Solid Brass

**Hinge Swings:** 90° in and 90° out (at factory set position)

**Closing Type:** Self-centring when within 15° of closed position

**Cut-Out Required**

**Includes:** Gaskets, Screws, and Glass Fabrication Dimensions

**Standard:** DIN EN14428

**NOTE:** Door Glass width may require alteration from standard clearance deductions when adjusting angles. Call for details.

**For maximum weight and door width capacities please see [crlaurence.co.uk](http://crlaurence.co.uk)**

### Colours

Chrome version shown below. 20 attractive colours available. For details please see the flip out chart at the rear of this brochure or visit [crlaurence.co.uk](http://crlaurence.co.uk)



| Front View | Rear View | Cat No. / Description                                                                    |
|------------|-----------|------------------------------------------------------------------------------------------|
|            |           | <b>Cat. No. P1N337XX</b><br>Adjustable Wall Mount Full Back Plate<br><b>adjustable</b>   |
|            |           | <b>Cat. No. P1N344XX</b><br>Adjustable Wall Mount Offset Back Plate<br><b>adjustable</b> |
|            |           | <b>Cat. No. P1N345XX</b><br>Adjustable 135° Glass-to-Glass<br><b>adjustable</b>          |
|            |           | <b>Cat. No. P1N380XX</b><br>Adjustable 180° Glass-to-Glass<br><b>adjustable</b>          |





**Suitable for heavier glass**

### Specifications

**Glass Thickness:** 10mm to 12mm Toughened Safety Glass

**Construction:** Solid Brass

**Hinge Swings:** 90° in and 90° out

**Closing Type:** Self-centring when within 15° of closed position

**Cut-Out Required**

**Includes:** Gaskets, Screws, and Glass Fabrication Dimensions





**Standard:** DIN EN14428

**For maximum weight and door width capacities please see [crlaurence.co.uk](http://crlaurence.co.uk)**

### Colours

Chrome version shown below. 19 attractive colours available. For details please see the flip out chart at the rear of this brochure or visit [crlaurence.co.uk](http://crlaurence.co.uk)

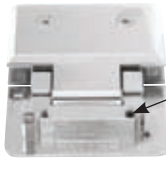

| View                                                                                                                                                                                                                                                             | Cat No. / Description                                                                                                                                                                                                                              | View                                                                                 | Cat No. / Description                                                                                                               |
|------------------------------------------------------------------------------------------------------------------------------------------------------------------------------------------------------------------------------------------------------------------|----------------------------------------------------------------------------------------------------------------------------------------------------------------------------------------------------------------------------------------------------|--------------------------------------------------------------------------------------|-------------------------------------------------------------------------------------------------------------------------------------|
|                                                                                                                                                                               | <p><b>Cat. No. C0L037XX</b><br/>Wall Mount Full Back Plate Standard Model</p> <p><b>Cat. No. C0L537XX</b><br/>5° Pre-Set Model<br/>(Factory set for 5° tighter closure into shower interior)</p>                                                   |  | <p><b>Cat. No. C0L180XX</b><br/>180° Glass-to-Glass</p>                                                                             |
|                                                                                                                                                                               | <p><b>Cat. No. C0L044XX</b><br/>Wall Mount Offset Back Plate Standard Model<br/>(Factory set for standard closing position)</p> <p><b>Cat. No. C0L544XX</b><br/>5° Pre-Set Model<br/>(Factory set for 5° tighter closure into shower interior)</p> |  | <p><b>Cat. No. C0L045XX</b><br/>135° Glass-to-Glass</p>                                                                             |
|                                                                                                                                                                               | <p><b>Cat. No. C0L092XX</b><br/>90° Glass-to-Glass</p>                                                                                                                                                                                             |  | <p>Internal View of Cologne Hinge</p> <p>Pin In Place (For "Mouse Ears" Cut-Out)</p> <p>Pin Removed (For Square Corner Cut-Out)</p> |
| <p><b>Pivot Pin</b><br/>See <a href="http://crlaurence.co.uk">crlaurence.co.uk</a> for more Pivot Pin information</p> <p>Pre-Set Closing Position (85°)</p> <p>Regular Closing Position (90°)</p> <p>Pin Rotates</p> <p>Custom Pivot Pin<br/>Cat. No. V1EP1N</p> |                                                                                                                                                                                                                                                    |                                                                                      |                                                                                                                                     |



### Specifications

**Glass Thickness:** 10mm to 12mm Toughened Safety Glass

**Special Feature:** Adjustable to any angle up to 90° without having to take door down

**Construction:** Solid Brass

**Hinge Swings:** 90° in and 90° out (at factory set position)

**Closing Type:** Self-centring when within 15° of closed position

**Cut-Out Required**

**Includes:** Gaskets, Screws, and Glass Fabrication Dimensions

**Standard:** DIN EN14428

**NOTE:** Door Glass width may require alteration from standard clearance deductions when adjusting angles. Call for details.

**For maximum weight and door width capacities please see [crlaurence.co.uk](http://crlaurence.co.uk)**

### Colours

Chrome version shown below. 17 attractive colours available. For details please see the flip out chart at the rear of this brochure or visit [crlaurence.co.uk](http://crlaurence.co.uk)



| Front View | Rear View | Cat No. / Description |
|------------|-----------|-----------------------|
|------------|-----------|-----------------------|

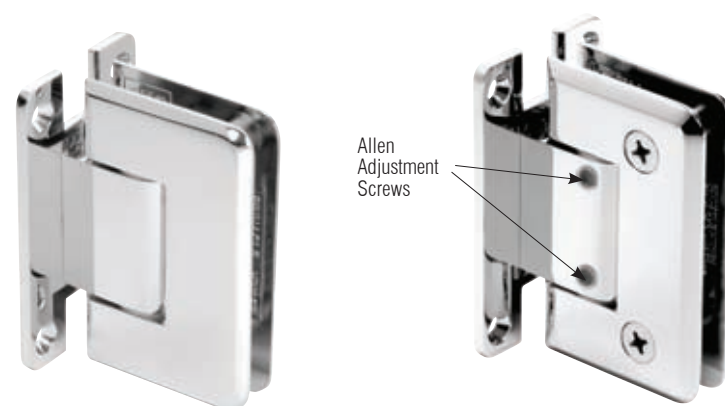

**Cat. No. C0L337XX**  
Adjustable Wall Mount Full Back Plate



**Cat. No. C0L380XX**  
Adjustable 180° Glass-to-Glass



# CRL Madrid Series Hinge / Clamp



## Specifications

**Glass Thickness:**  
8mm to 10mm Fixed Toughened Safety Glass  
10mm to 12mm Door Toughened Safety Glass

**Construction:** Solid Brass

**Hinge Swings:** Out only

**Closing Type:** Tight Closure to Strike Jamb (Not Supplied)

**No Cut-Out for Door; Fabrication Required for Fixed Panel Being Hinged From**

**Includes:** Gaskets and Mounting Hardware

**This Hinge Series is Patented (Patent Number 7,607,199)**

**For maximum weight and door width capacities please see [crlaurence.co.uk](http://crlaurence.co.uk)**

\*Mandatory use of 25 or 38mm heavy weight wall Dry Glaze U-Channel and Vinyl.

## Colours

Chrome version shown below. 5 attractive colours available. For details please see the flip out chart at the rear of this brochure or visit [crlaurence.co.uk](http://crlaurence.co.uk)

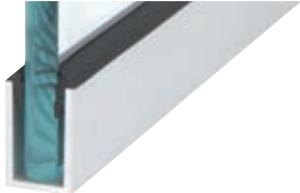

| View                                                                                                                                                                                                                                                                                                                                                                                                                                                                                                                                                                                                                                               | Cat No. / Description                                                        | View                                                                                                                   | Cat No. / Description                                                                                                                                                                                                  |
|----------------------------------------------------------------------------------------------------------------------------------------------------------------------------------------------------------------------------------------------------------------------------------------------------------------------------------------------------------------------------------------------------------------------------------------------------------------------------------------------------------------------------------------------------------------------------------------------------------------------------------------------------|------------------------------------------------------------------------------|------------------------------------------------------------------------------------------------------------------------|------------------------------------------------------------------------------------------------------------------------------------------------------------------------------------------------------------------------|
| <br><b>For 10mm and 12mm glass</b>                                                                                                                                                                                                                                                                                                                                                                                                                                                                                                                              | <b>Cat. No. MA06RHXX</b><br>Right Hand<br>For 10mm door and 12mm fixed panel | <br><b>For 10mm and 12mm glass</b> | <b>Cat. No. MA06LHXX</b><br>Right Hand<br>For 10mm door and 12mm fixed panel                                                                                                                                           |
| <br><b>For 8 and 10mm glass</b>                                                                                                                                                                                                                                                                                                                                                                                                                                                                                                                                 | <b>Cat. No. MA07RHXX</b><br>Right Hand<br>For 8mm door and 10mm fixed panel  | <br><b>For 8 and 10mm glass</b>    | <b>Cat. No. MA07LHXX</b><br>Right Hand<br>For 8mm door and 10mm fixed panel                                                                                                                                            |
| <p><b>IMPORTANT ORDERING TIPS:</b></p> <p>The MA06 and MA07 Hinge Sets are supplied complete with two Hinge/Clamps. When an order is placed for either the MA06 or MA07, one Hinge/Clamp for the top and one Hinge/Clamp for the bottom will be provided. The Hinge Sets are ordered as "Left Hand" or "Right Hand", as viewed from the outside of the shower. As an example, an MA06L is a set of both top and bottom hinges mounted to the left side of a door, when viewed from the outside of the shower. An MA06R is a set of both top and bottom hinges mounted to the right side of a door, when viewed from the outside of the shower.</p> |                                                                              |                                    | <p><b>Cat. No. WU3SASL*</b><br/>Satin Anodised<br/>25mm Deep Dry Glaze U-Channel</p> <p>(Also available in Brite Anodised, Brite Gold Anodised, Brushed Nickel Anodised and Painted Oil Rubbed Bronze finishes)</p>    |
| <p><b>Gaskets</b></p> <p><b>Cat. No. RG38100</b><br/>For 10mm fixed panel</p> <p><b>Cat. No. RG12100</b><br/>For 12mm fixed panel</p>                                                                                                                                                                                                                                                                                                                                                                                                                                                                                                              |                                                                              |                                    | <p><b>Cat. No. WU1SASL*</b><br/>Satin Anodised<br/>38mm Shallow Dry Glaze U-Channel</p> <p>(Also available in Brite Anodised, Brite Gold Anodised, Brushed Nickel Anodised and Painted Oil Rubbed Bronze finishes)</p> |



## Specifications

**Glass Thickness:** 8 to 10mm Toughened Safety Glass

**Special Feature:** Have ability to be side mounted at top and bottom corners of the door, or anywhere in-between. Corner mounting allows more glass exposure

**Construction:** Solid Brass

**Hinge Swings:** 90° in and 90° out (at factory set position)

**Closing Type:** Precise closing to 0 Degrees.

**Cut-Out and Hole Required**

**Includes:** One Hinge, Gaskets, Screws and Template







**Standard:** DIN EN14428

**For maximum weight and door width capacities please see [crlaurence.co.uk](http://crlaurence.co.uk)**

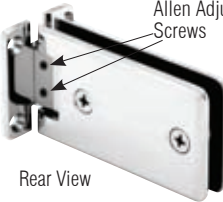
## Colours

Chrome version shown below. 8 attractive colours available. For details please see the flip out chart at the rear of this brochure or visit [crlaurence.co.uk](http://crlaurence.co.uk)



| View                                                                               | Cat. No. / Description                                                                                                                 | View                                                                                                               | Cat. No. / Description                                                                                    |
|------------------------------------------------------------------------------------|----------------------------------------------------------------------------------------------------------------------------------------|--------------------------------------------------------------------------------------------------------------------|-----------------------------------------------------------------------------------------------------------|
|  | <b>Cat. No. GRA037XX</b><br>Grande Wall Mount Standard Back Plate Hinge                                                                | <br>Allen Adjustment<br>Screws | <b>Cat. No. GRA337XX</b><br>Adjustable Standard Wall Mount Grande Series Hinge<br><b>adjustable</b>       |
|  | <b>Cat. No. GRA044XX</b><br>Grande Wall Mount Offset Back Plate Hinge                                                                  |                                | <b>Cat. No. GRA344XX</b><br>Adjustable Offset Wall Mount Grande Series Hinge<br><b>adjustable</b>         |
|  | <b>Cat. No. GRA090XX</b><br>Grande 90 Degree Glass-to-Glass Hinge                                                                      |                                | <b>Cat. No. GRA390XX</b><br>Adjustable 90 Degree Glass-to-Glass Grande Series Hinge<br><b>adjustable</b>  |
|  | <b>Cat. No. GRA180XX</b><br>Grande 180 Degree Glass-to-Glass Hinge<br><b>135 Degree Glass-to-Glass Hinge also available (GRA135XX)</b> |                                | <b>Cat. No. GRA380XX</b><br>Adjustable 180 Degree Glass-to-Glass Grande Series Hinge<br><b>adjustable</b> |





## Specifications

**Glass Thickness:** 8mm to 10mm Toughened Safety Glass

**Special Feature:** Top and Bottom Mount design allows more glass to show. Use of these hinges reduce quantity of cut-outs required when compared to standard side mount glass-to-glass hinges. Cat. No. PPH01 can be mounted floor and ceiling, or floor and header

**Construction:** Solid Brass

**Hinge Swings:** Full Rotation

**Closing Type:** Self-centring when within 15° of closed position

**Cut-Out Required**

**Includes:** Gaskets, Screws, and Glass Fabrication Dimensions

**This hinge series is patented (Patent Number 5297313)**

**For maximum weight and door width capacities please see [crlaurence.co.uk](http://crlaurence.co.uk)**

**Pivot Pin Available**  
See [crlaurence.co.uk](http://crlaurence.co.uk) for more information

## Colours

Chrome version shown below. 20 attractive colours available. For details please see the flip out chart at the rear of this brochure or visit [crlaurence.co.uk](http://crlaurence.co.uk)



| View                                                                                | Cat. No. / Description                                                                                             | View                                                                                 | Cat. No. / Description                                                                                       |
|-------------------------------------------------------------------------------------|--------------------------------------------------------------------------------------------------------------------|--------------------------------------------------------------------------------------|--------------------------------------------------------------------------------------------------------------|
|   | <b>Cat. No. PPH01XX</b><br>Top or Bottom Mount<br>Can be adapted to Deluxe Header Kit                              |  | <b>Cat. No. PPH03XX</b><br>L-Bracket Wall Mount                                                              |
|   | <b>Cat. No. PPH06XX</b><br>Top Mount<br>Compatible only with EZ-Adjust Header. Use Cat. No. PPH01 as bottom hinge. |  | <b>Cat. No. PPH135LXX</b><br>135° Glass-to-Glass<br>Left Hand Mount when viewed from outside of shower       |
|  | <b>Cat. No. PPH02XX</b><br>Glass-to-Fixed Transom Mount                                                            |  | <b>Cat. No. PPH135RXX</b><br>135° Glass-to-Glass<br>Right Hand Mount when viewed from outside of shower      |
|   | <b>Cat. No. PPH07XX</b><br>Top or Bottom Mount with Attached U-Clamp                                               |  | <b>Cat. No. PPH05LXX</b><br>Offset Bracket Wall Mount<br>Left Hand Mount when viewed from outside of shower  |
|                                                                                     |                                                                                                                    |  | <b>Cat. No. PPH05RXX</b><br>Offset Bracket Wall Mount<br>Right Hand Mount when viewed from outside of shower |
|                                                                                     |                                                                                                                    |  | <b>adjustable</b><br><b>Cat. No. PPH301XX</b><br>CRL Chrome Adjustable Prima Series Hinge                    |

# CRL Junior & Senior Prima Series



## Specifications

**Glass Thickness:** Prima Senior - 12mm Toughened Safety Glass

**Glass Thickness:** Prima Junior - 6mm Toughened Safety Glass

**Junior Prima Special Feature:** Top and bottom mount allows more glass exposure. Can also save on glass fabrication costs when compared to use of Side Mount Glass-to-Glass Hinges requiring more cut-outs.

**Construction:** Solid Brass

**Hinge Swings:** Full Rotation

**Closing Type:** Self-centring when within 15° of closed position

**Cut-Out Required**

**Includes:** Gaskets, Screws, and Glass Fabrication Dimensions. Adjustable Prima also includes 3mm Allen Wrench.





**For maximum weight and door width capacities please see [crlaurence.co.uk](http://crlaurence.co.uk)**

**Pivot Pin Available**  
See [crlaurence.co.uk](http://crlaurence.co.uk) for more information

## Colours

Chrome version shown below. 5 attractive colours available. For details please see the flip out chart at the rear of this brochure or visit [crlaurence.co.uk](http://crlaurence.co.uk)



| View                                                                                | Cat No. / Description                                                                      | View                                                                                 | Cat No. / Description                                                                             |
|-------------------------------------------------------------------------------------|--------------------------------------------------------------------------------------------|--------------------------------------------------------------------------------------|---------------------------------------------------------------------------------------------------|
|  | <b>PRIMA SENIOR</b><br>Cat. No. SRPPH01XX<br>Top or Bottom Mount<br><b>For 12mm glass</b>  |  | <b>PRIMA JUNIOR</b><br>Cat. No. JRPPH01XX<br>Top or Bottom Mount<br><b>For 6mm glass</b>          |
|  | <b>PRIMA SENIOR</b><br>Cat. No. SRPPH02XX<br>Glass-to-Glass Mount<br><b>For 12mm glass</b> |  | <b>PRIMA JUNIOR</b><br>Cat. No. JRPPH02XX<br>Glass-to-Fixed Transom Mount<br><b>For 6mm glass</b> |

## Flush Mount

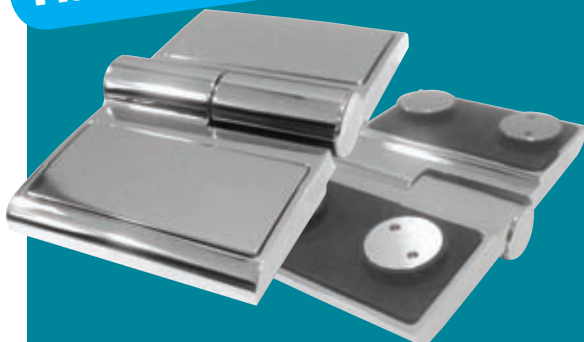

**Cat. No. R1V180LCH**  
180° Glass-to-Glass

**Cat. No. R1V180RCH**  
180° Glass-to-Glass

**Cat. No. R1V90LCH**  
90° Glass-to-Glass

**Matching Glass Clamps available see page 23**

## CRL Riviera Hinges

### Specifications

**Glass Thickness:** 8mm and 10mm Toughened Safety Glass

**Special Feature:** Flush mount in the inside of the panel and door  
Door and fixed panel can adjust vertically up to 10mm

**Hinge Swings:** Door opens outwards 170 degrees only

**Closing Type:** Self closing from 25° of closed position

**Cut-Out:** Required for fixed panel and door

**For maximum weight and door width capacities please see [crlaurence.co.uk](http://crlaurence.co.uk)**

### Colours

Chrome finish only

# CRL Serenity Series Sliding Door System



## Specifications

**Glass Thickness:** 8mm or 10mm Toughened Safety Glass

**Construction:** Stainless steel

**Maximum Door Weight:** Do not exceed either 762mm wide or 40kg

**Fabrication:** Holes required in both door and fixed panel (see [crlaurence.co.uk](http://crlaurence.co.uk))

## Colours

Polished Stainless (PS) shown below, also available in Brushed Stainless (BS). For details please see the flip out chart at the rear of this brochure or visit [crlaurence.co.uk](http://crlaurence.co.uk)



View

Cat No. / Description



### Cat. No. SERF2XX

#### Standard 180 Degree Kit Includes:

- 1 - 2m length header support bar
- 2 - Rollers
- 2 - Stoppers
- 2 - Anti-lift fittings
- 2 - Track holder fittings for wall
- 2 - Track holder fittings for fixed panel
- 1 - Thru-glass pull
- 1 - Door guide



### Cat. No. SER90XX

Accessory kit for 90 degree return  
Connects to wall fitting for 90 degree installations

90 degree  
return kit



# CRL Hydroslide Sliding Shower Door Kits



## Specifications

**Glass Thickness:** 8mm or 10mm Toughened Safety Glass

**Construction:** Plated or Lacquered Solid Brass Fittings; Anodised Aluminium Sliding Door Track

**Maximum Door Weight:** 40kg

**Includes:** Gaskets, Screws, and Glass Fabrication Information. Complete installation instructions along with glass and metal cutting formula available at [crlaurence.co.uk](http://crlaurence.co.uk)

## Colours

Chrome (CH) version shown below. 4 attractive colours available, Chrome (CH), Brass (BR), Brushed Nickel (BN), and Oil Rubbed Bronze (ORB). For details please see the flip out chart at the rear of this brochure or visit [crlaurence.co.uk](http://crlaurence.co.uk)



View

Cat No. / Description



**Cat. No. HYDK60XX** 180° Standard Kit 1524mm  
**Cat. No. HYDK84XX** 180° Standard Kit 2134mm

### 180° Standard Kit Consists of:

- |                                                  |                                              |
|--------------------------------------------------|----------------------------------------------|
| 1 - Sliding Glass Door Upper Track               | 2 - Hangers for Sliding Glass Door           |
| 2 - Sliding Glass Door Rollers                   | 2 - Sliding Glass Door Roller Stops          |
| 1 - Sliding Glass Door Floor Guide               | 2 - 90 Degree Wall-to-Upper Track Connectors |
| 1 - 914mm Half-Round SDT980 Threshold            | 1 - 2489mm DK98L L-Seal for wall             |
| 2 - 180 Degree Glass-to-Sliding Track Connectors |                                              |

NOTE: Bottom Fixed Glass Attachments, Handles or Knobs must be ordered separately.

### Cat. No. HYDA9XX

#### 90° Wall-to-Glass Accessory Kit Consists of:

- |                                                |                                     |
|------------------------------------------------|-------------------------------------|
| 1 - 90 Degree Glass-to-Sliding Track Connector | 1 - 90 Degree Wall-to-Glass Bracket |
|------------------------------------------------|-------------------------------------|

\*90 Degree Units require that you order one 180 Degree Standard Kit plus one 90 Degree Accessory Kit



# CRL Essence Series Sliding Shower Door System



## Specifications

**Glass Thickness Range:** 12mm toughened safety glass (Not included)

**Material:** Rollers and top guide, constructed of solid brass; bottom sliding track and U-Channel constructed of aluminium; clear plastic L-jamb

**Maximum Door Size:** Do not exceed either 787mm wide or 50.8 kg

**Basic Kit Fabrication:** Notch required for bottom rollers, holes required for top guide (see [crlaurence.co.uk](http://crlaurence.co.uk) for details)

## Colours

Chrome (CH) version shown below.  
4 attractive colours available, Chrome (CH), Brass (BR), Brushed Nickel (BN), and Oil Rubbed Bronze (ORB). For details please see the flip out chart at the rear of this brochure or visit [crlaurence.co.uk](http://crlaurence.co.uk)



View

Cat No. / Description



**Cat. No. ESS1XX** Basic Essence Kit

**Basic ESS1 kit includes the following:**

- 2 - Bottom Rollers
- 1 - Top Door Guide
- 1 - 1.63m Length Bottom Track
- 1 - 2.49m Length U-Channel
- 1 - 2.49m Length Plastic L-Seal
- 1 - SDCEC12 End Cap for Channel
- 1 - M6164 Shower Door Bumper

NOTE: Glass Clamps, Handle or Knob, and Other Accessories Sold Separately.

\*90 Degree Units require that you order two each CL90S wall mount brackets, two each CL090 90 degree glass-to-glass brackets, and a basic ESS1 kit in your choice of finish.

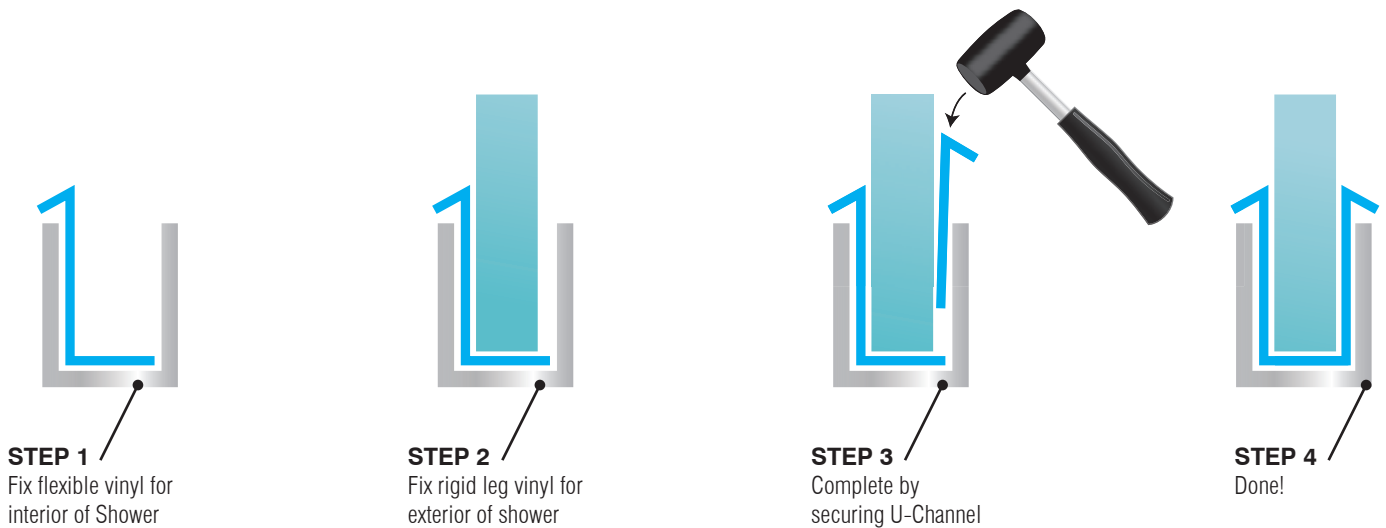

| View | Features                                                                                                                                                                                                                                                                                                                                                                                           | Cat No. / Description                                                                                                                                         |
|------|----------------------------------------------------------------------------------------------------------------------------------------------------------------------------------------------------------------------------------------------------------------------------------------------------------------------------------------------------------------------------------------------------|---------------------------------------------------------------------------------------------------------------------------------------------------------------|
|      | <ul style="list-style-type: none"> <li>• Clear vinyl secures glass in channel and eliminate the need for messy silicone</li> <li>• Recess in bottom channel hides caulk line</li> <li>• Channel and matching end caps available in several popular finishes</li> </ul>                                                                                                                             | <p><b>Cat. No. DUC38XX</b><br/>CRL Dry Glaze U-Channel for 10mm Glass only</p> <p><b>Cat. No. DUC516XX</b><br/>CRL Dry Glaze U-Channel for 8mm Glass only</p> |
|      | <ul style="list-style-type: none"> <li>• Extremely versatile extrusion in several popular finishes</li> <li>• Wet glazed with clear silicone to secure glass</li> <li>• Popular 2.49m lengths</li> <li>• Five popular finishes available</li> </ul>                                                                                                                                                | <p><b>Cat. No. SDCD516XX</b><br/>CRL Single U-Channel for 8mm Glass</p>                                                                                       |
|      | <ul style="list-style-type: none"> <li>• Deep pocket for securing fixed panels of glass</li> <li>• May be used alone or with regular depth U-Channel</li> <li>• Wet glazed with clear silicone to secure glass</li> <li>• Popular 2.49m lengths</li> <li>• Visit <a href="http://crlaurence.co.uk">crlaurence.co.uk</a> for other available finishes and economical 3.66m stock lengths</li> </ul> | <p><b>Cat. No. SDCD38XX</b><br/>CRL Deep U-Channel for 10mm Glass</p> <p><b>Cat. No. SDCD12XX</b><br/>CRL Deep U-Channel for 12mm Glass</p>                   |
|      | <ul style="list-style-type: none"> <li>• Covers Open End of SDCD38 Series U-Channels</li> <li>• Visit <a href="http://crlaurence.co.uk">crlaurence.co.uk</a> for other available finishes</li> </ul>                                                                                                                                                                                               | <p><b>Cat. No. SDCEC38XX</b><br/>End Cap</p>                                                                                                                  |
|      | <ul style="list-style-type: none"> <li>• Covers Open End of SDCD12 and DUC38 Series U-Channels</li> <li>• Visit <a href="http://crlaurence.co.uk">crlaurence.co.uk</a> for other available finishes</li> </ul>                                                                                                                                                                                     | <p><b>Cat. No. SDCEC12XX</b><br/>End Cap</p>                                                                                                                  |



# **Glass Clamps, Pull Handles & Knobs**

CRL Wall Mount Clamps mount directly to the wall, ceiling or floor to secure vertical fixed glass panels in contemporary shower enclosures. We also offer Glass-to-Glass Clamps that assist in maintaining the frameless appearance and provide a clean looking alternative to a U-Channel.

Our offering has evolved over the years to over 25 series of Glass Clamps in various configurations and beautiful finishes.

**CRL**<sup>®</sup>  
crlaurence.co.uk



# CRL Square Style Heavy-Duty Glass Clamps



## Specifications

**Glass Thickness:** 10mm to 12mm

**Construction:** Solid Brass

**Glass Fabrication Required:** SGCU1 requires notch; other clamps require holes or hole and notch combination

**Includes:** Mounting Screws and Gaskets

**Colours:** Chrome version shown below. 20 attractive colours available. For details please see the flip out chart at the rear of this brochure or visit [crlaurence.co.uk](http://crlaurence.co.uk)



| View | Cat No. / Description                                                                                                                                                                                            | View | Cat No. / Description                                                                              | View | Cat No. / Description                                                                                         |
|------|------------------------------------------------------------------------------------------------------------------------------------------------------------------------------------------------------------------|------|----------------------------------------------------------------------------------------------------|------|---------------------------------------------------------------------------------------------------------------|
|      | <b>Cat. No. CAT. NO. SCU4XX</b><br>Square Wall Mount Clamp<br>(Hole-in-Glass Style)<br><br><b>Cat. No. CAT. NO. SCU48CH</b><br>For 8mm Glass<br>Chrome finish only<br><br>Size: 51mm W x 51mm H                  |      | <b>Cat. No. SGC180XX</b><br>Square 180° Glass-to-Glass Clamp<br><br>Size: 127mm W x 51mm H         |      | <b>Cat. No. SGC188XX</b><br>Square 180° Glass-to-Glass Movable<br>Transom Clamp<br><br>Size: 103mm W x 51mm H |
|      | <b>Cat. No. SGCU1XX</b><br>Square Wall Mount Clamp<br>(Notch-in-Glass Style)<br><br>Size: 51mm W x 51mm H                                                                                                        |      | <b>Cat. No. SGC135XX</b><br>Square 135° Glass-to-Glass Clamp<br><br>Each Leg Size: 64mm W x 51mm H |      | <b>Cat. No. SGCU1GXX</b><br>Replacement Gasket<br>Notch Style                                                 |
|      | <b>Cat. No. SGC037XX</b><br>Fixed Panel Square Clamp<br>(with Small Leg)<br><br>Clamp Size: 51mm W x 51mm H<br>Leg Size: 35mm W x 51mm H                                                                         |      | <b>Cat. No. SGC90XX</b><br>Square 90° Glass-to-Glass Clamp<br><br>Each Leg Size: 64mm W x 51mm H   |      | <b>Cat. No. SCU4GXX</b><br>Replacement Gasket<br>Hole Style                                                   |
|      | <b>Cat. No. SGC039XX</b><br>Fixed Panel Square Clamp<br>(with Large Leg)<br><br><b>Cat. No. SGC0398CH</b><br>For 8mm Glass<br>Chrome finish only<br><br>Clamp Size: 51mm W x 51mm H<br>Leg Size: 51mm W x 51mm H |      | <b>Cat. No. SGC186XX</b><br>Square Wall Mount Movable Transom<br>Clamp<br><br>51mm W x 51mm H      |      |                                                                                                               |

# CRL Bevelled Style Heavy-Duty Glass Clamps



## Specifications

**Glass Thickness:** 10mm to 12mm











**Construction:** Solid Brass

**Glass Fabrication Required:** BGCU1 requires notch; other clamps require holes or hole and notch combinations





**Includes:** Mounting Screws and Gaskets

**Colours:** Chrome version shown below. 20 attractive colours available. For details please see the flip out chart at the rear of this brochure or visit [crlaurence.co.uk](http://crlaurence.co.uk)



| View                                                                               | Cat No. / Description                                                                                                                                                                                                         | View                                                                                | Cat No. / Description                                                                                      | View                                                                                                                                                                                                                                                                                                                                                                                                                                                                                                                                                                                                                                                                                                         | Cat No. / Description                                                                                              |
|------------------------------------------------------------------------------------|-------------------------------------------------------------------------------------------------------------------------------------------------------------------------------------------------------------------------------|-------------------------------------------------------------------------------------|------------------------------------------------------------------------------------------------------------|--------------------------------------------------------------------------------------------------------------------------------------------------------------------------------------------------------------------------------------------------------------------------------------------------------------------------------------------------------------------------------------------------------------------------------------------------------------------------------------------------------------------------------------------------------------------------------------------------------------------------------------------------------------------------------------------------------------|--------------------------------------------------------------------------------------------------------------------|
|   | <p><b>Cat. No. BCU4XX</b><br/>Square Wall Mount Clamp<br/>(Hole-in-Glass Style)</p> <p><b>Cat. No. BCU48CH</b><br/>For 8mm Glass<br/>Chrome finish only</p> <p>Size: 51mm W x 51mm H</p>                                      |   | <p><b>Cat. No. BGC180XX</b><br/>Square 180° Glass-to-Glass Clamp</p> <p>Size: 127mm W x 51mm H</p>         |                                                                                                                                                                                                                                                                                                                                                                                                                                                                                                                                                                                                                          | <p><b>Cat. No. BGC188XX</b><br/>Square 180° Glass-to-Glass Movable Transom Clamp</p> <p>Size: 103mm W x 51mm H</p> |
|  | <p><b>Cat. No. BGC1XX</b><br/>Square Wall Mount Clamp<br/>(Notch-in-Glass Style)</p> <p>Size: 51mm W x 51mm H</p>                                                                                                             |  | <p><b>Cat. No. BGC135XX</b><br/>Square 135° Glass-to-Glass Clamp</p> <p>Each Leg Size: 64mm W x 51mm H</p> |                                                                                                                                                                                                                                                                                                                                                                                                                                                                                                                                                                                                                         | <p><b>Cat. No. BGC1GXX</b><br/>Replacement Gasket<br/>Notch Style</p>                                              |
|  | <p><b>Cat. No. BGC037XX</b><br/>Fixed Panel Square Clamp<br/>(with Small Leg)</p> <p><b>Cat. No. BGC0398CH</b><br/>For 8mm Glass<br/>Chrome finish only</p> <p>Clamp Size: 51mm W x 51mm H</p> <p>Leg Size: 35mm W x 51mm</p> |  | <p><b>Cat. No. BGC90XX</b><br/>Square 90° Glass-to-Glass Clamp</p> <p>Each Leg Size: 64mm W x 51mm H</p>   |                                                                                                                                                                                                                                                                                                                                                                                                                                                                                                                                                                                                                         | <p><b>Cat. No. BCU4GXX</b><br/>Replacement Gasket<br/>Hole Style</p>                                               |
|  | <p><b>Cat. No. BGC039XX</b><br/>Fixed Panel Square Clamp<br/>(with Large Leg)</p> <p>Clamp Size: 51mm W x 51mm H</p> <p>Leg Size: 51mm W x 51mm H</p>                                                                         |  | <p><b>Cat. No. BGC186XX</b><br/>Square Wall Mount Movable Transom Clamp</p> <p>51mm W x 51mm H</p>         | <div style="background-color: #008080; color: white; padding: 5px; text-align: center;"> <b>CRL Riviera</b> <span style="float: right; background-color: white; color: #008080; padding: 2px 5px; font-weight: bold;">Flush Mount</span><br/> <b>Hinge Glass Clamp</b> </div> <div style="display: flex; align-items: center; justify-content: center; margin-top: 10px;">  <div style="margin-left: 10px;"> <p><b>Cat. No. R1V90CH</b><br/>90 degree Glass to Wall clamp with flush mount internal surface</p> <p>Clamp size: 67mm W x 79mm H</p> <p>Leg size: 84mm W x 79mm H</p> </div> </div> |                                                                                                                    |

# CRL Adjustable Glass Clamps

| View                                                                             | Rear View                                                                         | Cat No. / Description                                                                                                                                                                                                                                   |
|----------------------------------------------------------------------------------|-----------------------------------------------------------------------------------|---------------------------------------------------------------------------------------------------------------------------------------------------------------------------------------------------------------------------------------------------------|
|  |  | <p><b>Cat. No. ADJ037XX</b><br/>Adjustable Wall Mount Clamp</p> <p>Size: 49mm Wide x 44mm High</p> <p>Glass Thickness Range: 8mm to 12mm</p> <p>Hole Diameter Required: 22mm</p> <p>Includes: Clear Gaskets and Mounting Screw</p>                      |
|  |  | <p><b>Cat. No. ADJ180XX</b><br/>Adjustable Glass-to-Glass Mount Clamp</p> <p>Size: 49mm Wide (each leg) x 44mm High</p> <p>Glass Thickness Range: 8mm to 12mm</p> <p>Hole Diameter Required: 22mm</p> <p>Includes: Clear Gaskets and Mounting Screw</p> |

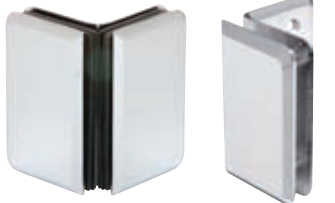

## Glass Brackets to match Hinges

| Front View                                                                         | Cat No. / Description                                                                                                                                                                                                                                     |
|------------------------------------------------------------------------------------|-----------------------------------------------------------------------------------------------------------------------------------------------------------------------------------------------------------------------------------------------------------|
|   | <p><b>To suit: Geneva, Concord, Vienna, Cardiff and Senior Cardiff Range</b></p> <p><b>Cat. No. GE090SXX</b><br/>Glass-to-Glass Bracket</p> <p><b>Cat. No. GE90SXX</b><br/>Wall Mount Bracket</p> <p>Matches configuration of the hinges listed above</p> |
|  | <p><b>To suit: Pinnacle, Prima, Senior Prima, Cologne and Estate Range</b></p> <p><b>Cat. No. P1090XX</b><br/>Glass-to-Glass Bracket</p> <p><b>Cat. No. P190SXX</b><br/>Wall Mount Bracket</p> <p>Matches configuration of the hinges listed above</p>    |

**Colours:** Chrome version shown opposite. 14 attractive colours available.

For details please see the flip out chart at the rear of this brochure or visit [crlaurence.co.uk](http://crlaurence.co.uk)

Glass Thickness Range: 8 to 12mm  
Hole Diameter Required: 19mm



**Colours:** Chrome version shown opposite. 14 attractive colours available.

For details please see the flip out chart at the rear of this brochure or visit [crlaurence.co.uk](http://crlaurence.co.uk)

Glass Thickness Range: 8 to 12mm  
Hole Diameter Required: 19mm



## CRL Traditional Style Glass Clamps

| View                                                                               | Cat No. / Description                                                                                                                                                                                                                                                                                                   | View                                                                                 | Cat No. / Description                                                                                                                                                                                                                                                                                                                          |
|------------------------------------------------------------------------------------|-------------------------------------------------------------------------------------------------------------------------------------------------------------------------------------------------------------------------------------------------------------------------------------------------------------------------|--------------------------------------------------------------------------------------|------------------------------------------------------------------------------------------------------------------------------------------------------------------------------------------------------------------------------------------------------------------------------------------------------------------------------------------------|
|  | <p><b>Cat. No. UC77XX</b><br/>Traditional Style Fixed Panel U-Clamp</p> <p>Glass Thickness Range: 8mm to 12mm</p> <p>Hole Diameter Required: 16 or 19mm</p> <p>Includes: Mounting Screws (for Wall Clamps) and Clear Gaskets</p> <p>*An additional set of clear gaskets (Cat. No. UCG77) is required for 8mm glass.</p> |  | <p><b>Cat. No. GCB90XX</b><br/>90 Degree Traditional Style Glass-to-Glass Clamp</p> <p>Glass Thickness Range: 8mm to 10mm</p> <p>Hole Diameter Required: 16 or 19mm</p> <p>Includes: Gaskets and Wood Screw for wall mount application.</p> <p>*An additional set of gaskets is required for 8mm glass (Cat. No. UCG77)</p>                    |
|  | <p><b>Cat. No. GCB184XX</b><br/>180 Degree Traditional Style Double Stud Glass-to-Glass Clamp</p> <p>Glass Thickness Range: 8mm to 12mm</p> <p>Hole Diameter Required: 16 or 19mm</p> <p>Includes: Gaskets.</p> <p>*An additional set of gaskets is required for 8mm glass (Cat. No. GCBG184).</p>                      |  | <p><b>Cat. No. GCB182XX</b><br/>180 Degree Traditional Style Split Face and "Y" Inline Glass-to-Glass Clamp</p> <p>Glass Thickness Range: 8mm to 12mm</p> <p>Hole Diameter Required: 16 or 19mm</p> <p>Includes: Gaskets, Screw for "Y" Inline Clamp use.</p> <p>*An additional set of gaskets is required for 8mm glass (Cat. No. UCG77).</p> |

# CRL Pull Handles and Knobs

**View**

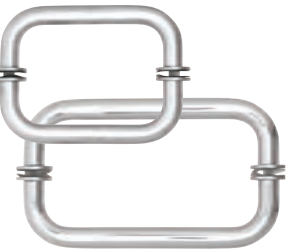

**Cat No. / Description**

**BM Series Back-to-Back Pull Handles**

**Cat. No. BM6X6XX**  
152mm size with metal washers

**Cat. No. BM8X8XX**  
203mm size with metal washers

Material: 19mm Diameter Brass Tubing (1.5mm thick), 31.8mm Diameter Washers

Glass Thickness Range: 6mm to 12mm

Hole Diameter Required: 12mm

Centre-to-Centre Hole: 152mm; 203mm

**BM Series Back-to-Back Pull Handles**

**Cat. No. BMN6X6XX**  
152mm size without metal washers

**Cat. No. BMN8X8XX**  
203mm size without metal washers

Material: 19mm Diameter Brass Tubing (1.5mm thick)

Glass Thickness Range: 6mm to 12mm

Hole Diameter Required: 12mm

Centre-to-Centre Hole: 152mm; 203mm

**Crescent Style Back-to-Back Pull Handles**

**Cat. No. CSH6X6XX** 152mm

**Cat. No. CSH8X8XX** 203mm

Material: 19mm Brass Tubing

Glass Thickness Range: 6mm to 12mm

Hole Diameter Required: 12mm

Centre-to-Centre Hole: 152mm; 203mm

**SQ Series Square Tubing Mitred Corner Back-to-Back Pull Handles**

**Cat. No. SQ6X6XX** 152mm

**Cat. No. SQ8X8XX** 203mm

Material: 19mm Brass Tubing

Glass Thickness Range: 6mm to 12mm

Hole Diameter Required: 12mm

Centre-to-Centre Hole: 152mm, 203mm

**MT Series Round Tubing Mitred Corner Back-to-Back Pull Handles**

**Cat. No. MT6X6XX** 152mm

**Cat. No. MT8X8XX** 203mm

Material: 19mm Brass Tubing; 31.75mm Metal Washers

Glass Thickness Range: 6mm to 12mm

Hole Diameter Required: 12mm

Centre-to-Centre Hole: 152mm, 203mm

**RM Series Flat Outside Surface/Round Tubing Inside Back-to-Back Pull Handles**

**Cat. No. RM6X6XX** 152mm

**Cat. No. RM8X8XX** 203mm

Material: 19mm Brass Tubing

Glass Thickness Range: 6mm to 12mm

Hole Diameter Required: 12mm

Centre-to-Centre Hole: 152mm, 203mm

**View**



**Cat No. / Description**

**CRL SDK Series Knobs**

**Cat. No. SDK106XX**  
30mm Round Knob Set

Material: Solid Brass Material

Glass Thickness Range: Fits 6 to 12mm Thick Glass

Available in Several Attractive Finishes

Hole  $\varnothing$  10 or 12mm

**CRL SDK Series Knobs**

**Cat. No. SDK160XX**  
30mm Square Knob Set

Material: Solid Brass Material

Glass Thickness Range: Fits 6 to 12mm Thick Glass

Available in Several Attractive Finishes

Hole  $\varnothing$  12mm

**CRL SDK Series Knobs**

**Cat. No. SDK140XX**  
25mm Round Knob Set

Material: Solid Brass Material

Glass Thickness Range: Fits 6 to 12mm Thick Glass

Available in Several Attractive Finishes

Hole  $\varnothing$  10 or 12mm

**CRL SDK Series Knobs**

**Cat. No. SDK112XX**  
19mm Square Knob Set without Plastic Sleeve

**Cat. No. SDKP112XX**  
19mm Square Knob Set with Plastic Sleeve

Material: Solid Brass Material

Glass Thickness Range: Fits 6 to 12mm Thick Glass

Available in Several Attractive Finishes

Hole  $\varnothing$  10 or 12mm

**CRL Chrome Back-to-Back Bow-Tie Style Knobs**

**Cat. No. SDK109XX**  
Back-to-Back Knob

Solid Brass Material

Fits 6 to 12mm Thick Glass

Available in Several Beautiful Finishes

Hole  $\varnothing$  10 or 12mm

**Cat. No. LP6X6XX**  
152mm Handle

**Cat. No. LP8X8XX**  
203mm Handle

**Mounting Holes / Centre-to-centre**  
152mm / 203mm

Material: 19mm Brass Tubing 152 and 203mm Sizes  
32mm Brass Tubing All Other

Glass Thickness Range: 8mm to 12mm

Hole Diameter Required: For 152 and 203mm  
Handles: 12mm





A modern bathroom with a bathtub, a glass shower enclosure, and a towel bar. The scene is dimly lit, with a teal square graphic element on the left side.

# Support & Towel Bars



Our range of Support Bars comes in a variety of lengths and finishes, suitable for different glass thicknesses, to enable you to create your perfect bathroom space.

Our range of Towel Bars will add a touch of elegance and class to your bathroom. Constructed of tubular brass, CRL's Towel Bars ensure your door installations will last for a long time as their lightweight properties help to keep the weight of the door hardware to a minimum.

All CRL Frameless Shower Door Hardware has consistent finishes and will instantly add a look of quality to the appearance of your enclosure, and with proper care and cleaning, will remain beautiful for years to come.

**CRL**<sup>®</sup>  
crlaurence.co.uk

## Thru-Glass to Wall Rod

| View | Specification                                                                                                                                                                                                                                                                                                                                                                                                                                          | Cat No. / Description                                                                                                              |
|------|--------------------------------------------------------------------------------------------------------------------------------------------------------------------------------------------------------------------------------------------------------------------------------------------------------------------------------------------------------------------------------------------------------------------------------------------------------|------------------------------------------------------------------------------------------------------------------------------------|
|      | <p>Material: 19mm Diameter Stainless Steel Tubing</p> <p>Bar Lengths: 1.83m</p> <p>Glass Thickness Range: 6 to 12mm</p> <p>Glass Fabrication Required: 12mm Diameter Hole</p> <p>Includes: 19mm Diameter End Cap on One End</p> <p>Polished Stainless (PS) shown, also available in Brushed Stainless (BS). For details please see the flip out chart at the rear of this brochure or visit <a href="http://crlaurence.co.uk">crlaurence.co.uk</a></p> | <p><b>Cat. No. TUBE3472XX</b><br/>Thru-Glass to Wall Rod</p> <p>Requires additional fitting for wall attachment i.e. S3 or S12</p> |

## Through-Glass Mounted Support Bar

The Through-Glass Mounted Support Bar creates a means of support that strengthens an enclosure's structural integrity. It may be used in place of a header in certain applications (call for details) and can be mounted to a wall, ceiling or glass-to-glass. Supplied Bar is 991mm long, requires a 16mm hole in the glass, and comes in finishes to match our Hinges and Pull Handles. All mounting hardware included.



| View | Specification                                                                                                                                                                                                                                                                        | Cat No. / Description                                                                                                                                         |
|------|--------------------------------------------------------------------------------------------------------------------------------------------------------------------------------------------------------------------------------------------------------------------------------------|---------------------------------------------------------------------------------------------------------------------------------------------------------------|
|      | <p>Choice of wall/ceiling mount or glass-to-glass mount</p> <p>Helps strengthen structural integrity of shower enclosure</p> <p>Stocked in numerous finishes, with custom finishes available</p> <p>991mm bar length, 1.08M overall length</p> <p>All mounting hardware included</p> | <p><b>Cat. No. SUP135XX</b><br/>Wall Mount</p> <p><b>Cat. No. SUP135G2GXX</b><br/>Glass-to-Glass Mount</p> <p>16mm <math>\varnothing</math> hole required</p> |

## Mitred Support Bar Bracket

The Mitred Support Bar Wall Mount Bracket is designed to attach to the wall by slipping over a screw mounted stud that is secured into the wall. Perfect for an inline panel needing to be secured to an adjacent wall for stability. The Bracket comes in matching finishes, and fits any of our Fixed Panel Support Bars. Mitre of Bracket ensures flush fit against wall.

| View                                            | Specification                                     | Cat No. / Description                                                                                                                                                                                                                                                                                                                                                     |
|-------------------------------------------------|---------------------------------------------------|---------------------------------------------------------------------------------------------------------------------------------------------------------------------------------------------------------------------------------------------------------------------------------------------------------------------------------------------------------------------------|
| <p><b>Cat. No. SBB45</b></p> <p>45° Bracket</p> | <p><b>Cat. No. SBB22</b></p> <p>22.5° Bracket</p> | <p>A great solution for inline enclosures requiring fixed panel support when a header is not desired</p> <p>Can replace a fitting on the end of a stock support bar</p> <p>Attaches to wall easily via a screw-mounted stud</p> <p>Available in many popular finishes</p> <p><b>Cat. No. SBB45XX</b><br/>45° Bracket</p> <p><b>Cat. No. SBB22XX</b><br/>22.5° Bracket</p> |

These Fixed Panel Support Bars stabilize fixed panels of glass in enclosures that do not go all the way up to the ceiling. Bars are available in two lengths, and in sizes to secure 6mm to 12mm thick glass. Finishes are available to match most of our hinges, knobs, and pull handles. No holes or cut-outs are required in the glass.

| View                                                                                                          | Specification                                                                                                                                                                                                                                                                                                                                                                                                                                   | Cat No. / Description                                                                                                                                                                                                                                                                                                                       |
|---------------------------------------------------------------------------------------------------------------|-------------------------------------------------------------------------------------------------------------------------------------------------------------------------------------------------------------------------------------------------------------------------------------------------------------------------------------------------------------------------------------------------------------------------------------------------|---------------------------------------------------------------------------------------------------------------------------------------------------------------------------------------------------------------------------------------------------------------------------------------------------------------------------------------------|
|  <p><b>Glass-to-Glass</b></p> | <p>Material: 19mm Diameter Tubular Brass Bar, Solid Brass Fittings</p> <p>Colours: Chrome version shown opposite. 20 attractive colours available. For details please see the flip out chart at the rear of this brochure or visit <a href="http://crlaurence.co.uk">crlaurence.co.uk</a></p> <p>Bar Lengths: 1m; 1.3m</p> <p>Glass Thickness Range: 6mm to 8mm, and 10mm to 12mm</p> <p>Includes: All Required Mounting Hardware</p>           | <p><b>Cat. No. SUP26XX</b><br/>Glass-to-Glass Model<br/>Support Bar for 6mm to 8mm glass<br/>Length: 1m</p> <p><b>Cat. No. SUP20XX</b><br/>Glass-to-Glass Model<br/>Support Bar for 10mm to 12mm glass<br/>Length: 1m</p> <p><b>Cat. No. SUP20XX51</b><br/>Glass-to-Glass Model<br/>Support Bar for 10mm to 12mm glass<br/>Length: 1.3m</p> |
|  <p><b>Wall-to-Glass</b></p> | <p>Material: 19mm Diameter Tubular Brass Bar, Solid Brass Fittings</p> <p>Colours: Chrome version shown opposite. 20 attractive colours available. For details please see the flip out chart at the rear of this brochure or visit <a href="http://crlaurence.co.uk">crlaurence.co.uk</a></p> <p>Available Bar Lengths: 1m; 1.3m</p> <p>Glass Thickness Range: 6mm to 8mm, and 10mm to 12mm</p> <p>Includes: All Required Mounting Hardware</p> | <p><b>Cat. No. SUP06XX</b><br/>Wall-to-Glass Model<br/>Support Bar for 6mm to 8mm glass<br/>Length: 1m</p> <p><b>Cat. No. SUP10XX</b><br/>Wall-to-Glass Model<br/>Support Bar for 10mm to 12mm glass<br/>Length: 1m</p> <p><b>Cat. No. SUP10XX51</b><br/>Glass-to-Glass Model<br/>Support Bar for 10mm to 12mm glass<br/>Length: 1.3m</p>   |

| View                                                                               | Cat No. / Description                                                                                                                                                                                                                                                                                                                                               |
|------------------------------------------------------------------------------------|---------------------------------------------------------------------------------------------------------------------------------------------------------------------------------------------------------------------------------------------------------------------------------------------------------------------------------------------------------------------|
|  | <p><b>Cat. No. S3XX</b><br/>Wall Mount Fitting</p> <p>Chrome version shown opposite. 19 attractive colours available. For details please see the flip out chart at the rear of this brochure or visit <a href="http://crlaurence.co.uk">crlaurence.co.uk</a></p>                                                                                                    |
|  | <p><b>Cat. No. S4XX</b><br/>Swiveling U-Bracket for 6mm and 8mm Glass</p> <p><b>Cat. No. S5XX</b><br/>Swiveling U-Bracket for 10mm and 12mm Glass</p> <p>Chrome version shown opposite. 19 attractive colours available. For details please see the flip out chart at the rear of this brochure or visit <a href="http://crlaurence.co.uk">crlaurence.co.uk</a></p> |
|  | <p><b>Cat. No. S6XX</b><br/>Movable Bracket for 6mm Glass</p> <p><b>Cat. No. S7XX</b><br/>Movable Bracket for 10mm Glass</p> <p>Chrome version shown opposite. 19 attractive colours available. For details please see the flip out chart at the rear of this brochure or visit <a href="http://crlaurence.co.uk">crlaurence.co.uk</a></p>                          |
|  | <p><b>Cat. No. S8XX</b><br/>90° Corner Bracket for Support Bars</p> <p>Chrome version shown opposite. 19 attractive colours available. For details please see the flip out chart at the rear of this brochure or visit <a href="http://crlaurence.co.uk">crlaurence.co.uk</a></p>                                                                                   |

| View                                                                                 | Cat No. / Description                                                                                                                                                                                                                                                                                                                                |
|--------------------------------------------------------------------------------------|------------------------------------------------------------------------------------------------------------------------------------------------------------------------------------------------------------------------------------------------------------------------------------------------------------------------------------------------------|
|   | <p><b>Cat. No. S9XX</b><br/>Vertical Support Bracket for 6mm to 8mm Glass</p> <p><b>Cat. No. S910XX</b><br/>For 10mm to 12mm Glass</p> <p>Chrome version shown opposite. 19 attractive colours available. For details please see the flip out chart at the rear of this brochure or visit <a href="http://crlaurence.co.uk">crlaurence.co.uk</a></p> |
|  | <p><b>Cat. No. S12XX</b><br/>Slim Line Wall Mount Fitting</p> <p>Chrome version shown opposite. 19 attractive colours available. For details please see the flip out chart at the rear of this brochure or visit <a href="http://crlaurence.co.uk">crlaurence.co.uk</a></p>                                                                          |
|  | <p><b>Cat. No. S13XX</b><br/>Slim Line Glass Mount Fitting for 6mm to 12mm Glass</p> <p>Chrome version shown opposite. 19 attractive colours available. For details please see the flip out chart at the rear of this brochure or visit <a href="http://crlaurence.co.uk">crlaurence.co.uk</a></p>                                                   |
|  | <p><b>Cat. No. S1XX</b><br/>1m Bar Only</p> <p><b>Cat. No. S2XX</b><br/>1.3m Bar Only</p> <p><b>Cat. No. S80</b><br/>2.03m Bar Only</p> <p>Material: 19mm Diameter Tubular Brass Bar.<br/>Available Bar Lengths: 1m; 1.3m; 2.03m.<br/>Chrome version shown opposite. 19 attractive colours available.</p>                                            |



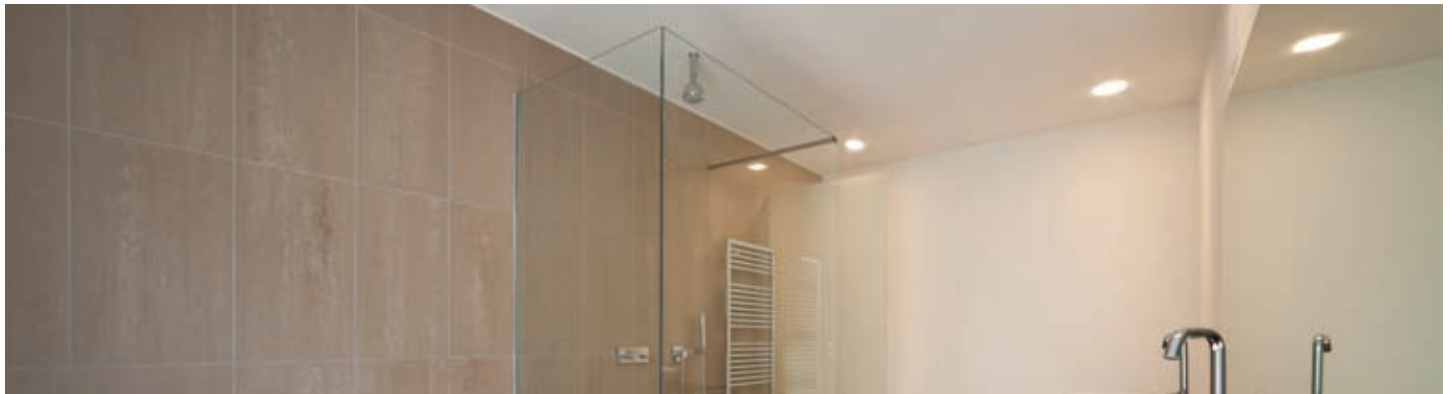

| View                                                                               | Specification                                                                                                                                                                                                                                                                                                                                                                                                                                                                     | Cat No. / Description                             |
|------------------------------------------------------------------------------------|-----------------------------------------------------------------------------------------------------------------------------------------------------------------------------------------------------------------------------------------------------------------------------------------------------------------------------------------------------------------------------------------------------------------------------------------------------------------------------------|---------------------------------------------------|
|  | <p>Material: 19mm square tubing, solid brass fittings</p> <p>Chrome version shown. 5 attractive colours available. For details please see the flip out chart at the rear of this brochure or visit <a href="http://crlaurence.co.uk">crlaurence.co.uk</a></p> <p>Bar Lengths: 1.5m</p> <p>New square tubing matches geometry of many popular CRL hinges</p> <p>Provides fixed panel support for enclosures not going to the ceiling</p> <p>No hole drilling required in glass</p> | <p><b>Cat. No. SQ59XX</b><br/>1.5m Square Bar</p> |

| View                                                                                | Cat No. / Description                                                                                                                                                             |
|-------------------------------------------------------------------------------------|-----------------------------------------------------------------------------------------------------------------------------------------------------------------------------------|
|  | <p><b>Cat. No. SQ41XX</b><br/>Swiveling U-Bracket for 6 to 8mm Glass for Square Bar</p> <p><b>Cat. No. SQ42XX</b><br/>Swiveling U-Bracket for 10 to 12mm Glass for Square Bar</p> |
|  | <p><b>Cat. No. SQ43XX</b><br/>Movable Bracket for 6 to 8mm Glass for Square Bar</p>                                                                                               |
|  | <p><b>Cat. No. SQ44XX</b><br/>Movable Bracket for 10 to 12mm Glass for Square Bar</p>                                                                                             |
|   | <p><b>Cat. No. SQ45XX</b><br/>Adjustable Corner Bracket for Square Bar</p>                                                                                                        |
|  | <p><b>Cat. No. SQ46XX</b><br/>Wall Mount Bracket for Square Bar</p>                                                                                                               |

| View                                                                                 | Cat No. / Description                                                            |
|--------------------------------------------------------------------------------------|----------------------------------------------------------------------------------|
|   | <p><b>Cat. No. SQ47XX</b><br/>45° Mitred Wall Mount Bracket for Square Bar</p>   |
|  | <p><b>Cat. No. SQ48XX</b><br/>22.5° Mitred Wall Mount Bracket for Square Bar</p> |
|  | <p><b>Cat. No. SQ49XX</b><br/>Adjustable Wall Mount Bracket for Square Bar</p>   |
|  | <p><b>Cat. No. SQ50XX</b><br/>"T" Junction Bracket for Square Bar</p>            |

# CRL EZ-Adjust Shower Door Header Kit



## Features

- Secures shower enclosure not going to ceiling
- Allows horizontal (side-to-side) adjustment of hinge after installation
- No hole drilling required through header for adaptor, if using Prima Hinge model PPH06 or Senior Prima Hinge model SRPPH06
- Constructed of heavy 6063-T5 aluminium alloy
- For use with 8mm, 10mm and 12mm thick glass

## Colours

Chrome version shown. 8 attractive colours available. For details please see the flip out chart at the rear of this brochure or visit [crlaurence.co.uk](http://crlaurence.co.uk)



| View | Specification | Cat No. / Description |
|------|---------------|-----------------------|
|------|---------------|-----------------------|

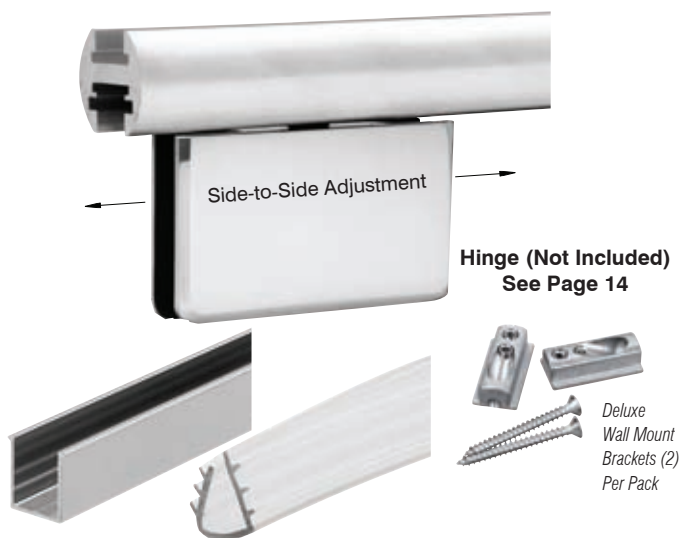

## Each Kit Contains

- 1 – 2.49m or 3.6m Header Length
- 1 – 914mm Snap-In Filler Insert for Door Pocket
- 1 – Deluxe Wall Mount Bracket Kit (Two Brackets)
- 2.44m or 3.65m of 8mm and 10mm Clear Vinyl

Vinyl not required for 12mm Glass

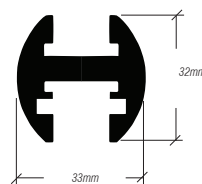

## Cat. No. EHK98XX

2.49m EZ-Adjust Shower Door Header Kit

## Cat. No. EHK144XX

3.65m EZ-Adjust Shower Door Header Kit

If using Prima Hinge Model PPH06 or Senior Prima Hinge Model SRPPH06, hinge can be adjusted side-to-side after installation. No drilling required to install hinge into header if using those hinges.

## CRL Deluxe Shower Door Header Kit



## Each Kit Contains

- 1.67m, 2.49m or 3.65m Piece of Header Extrusion
- .91m Piece of Snap-In Filler for Door Pocket
- Vinyl for 8mm and 10mm Glass (not needed for 12mm)
- Pack of two SHB100 Aluminium Wall Mounting Brackets and pack of two BWB2 Brass Wall Mounting Brackets (use set of your choice)

## SDH Series Flat/Round Profile

**Cat. No. SDH660XX**  
1.67m Deluxe Header Kit

**Cat. No. SDH980XX**  
2.49m Deluxe Header Kit

**Cat. No. SDH144XX**  
3.65m Deluxe Header Kit

## SQH Series Flat/Flat Profile

**Cat. No. SQH980XX**  
2.49m Deluxe Header Kit

# CRL Frameless Vertical Post System



## Specifications

- Stock or custom kits allow user to stabilise fixed panels of glass not going to ceiling
- Excellent alternative to traditional horizontal header systems
- Four popular stock finishes for 8, 10, and 12mm glass
- Glass fabrication required for tube adaptors/ end caps with 19mm holes
- Custom kits available in various finishes, post configurations, and with dome or ball style glue-in end caps (Two-Point System only)



## Cat No. / Description

### Cat. No. VPK33XX

#### Two Point Ceiling Mount System Kit

- 1 Each - 838mm length of 51mm diameter Round Tubing, two Rivet Nuts, and Flat Style End Cap
- 2 Each - Tube Adaptors with 38mm diameter End Caps (with Threaded Stud)
- 1 Each - Removable Top Flange with Set Screw

**NOTE:** There are size limitations when hinging a door off a panel fastened using the VPK33. Call our Frameless Shower Department for details.

## Cat No. / Description

### Cat. No. VPK92XX

#### Floor to Ceiling Mount System Kit

- 1 Each - 2300mm length of 51mm diameter Round Tubing, with welded Bottom Flange and two Rivet Nuts
- 2 Each - Tube Adaptors with 38mm diameter End Caps (with Threaded Stud)
- 1 Each - Removable Top Flange with Set Screw

**NOTE:** Stock Kit is prepared for one degree floor slope to the inside of the shower. Shimming is required if floor is not a one degree slope to the inside of the shower, or a Custom Kit may be ordered instead.

# CRL Glass Door Locks with Indicator

## Swinging Door Application

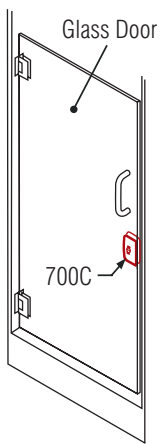

Lock on Single Door Glass-to-Wall

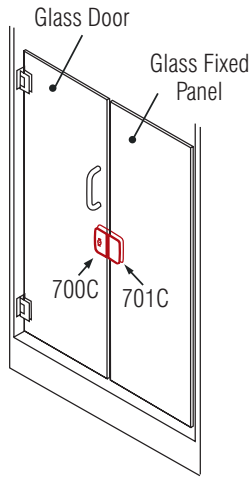

Lock and Receiver on Double Doors Glass-to-Glass

## Sliding Door Application

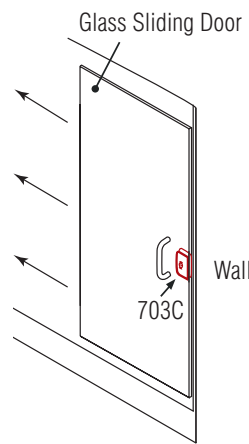

Lock on Single Glass-to-Wall Door

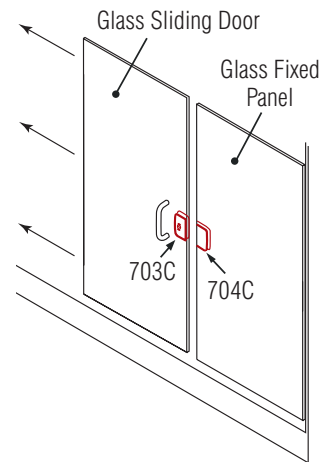

Lock and Keeper on Glass-to-Glass Doors



| Exterior View | Interior View | Cat No. / Description                           | Features                                                                                                                                                                                                                                                                                                                  |
|---------------|---------------|-------------------------------------------------|---------------------------------------------------------------------------------------------------------------------------------------------------------------------------------------------------------------------------------------------------------------------------------------------------------------------------|
|               |               | <b>Cat. No. 700CXX</b><br>Sliding Door Lock     | <ul style="list-style-type: none"> <li>• Choice of Swinging Door and Sliding Door Models</li> <li>• Lock Can Be Used Glass-to-Wall, or Glass-to-Glass With Optional Matching Receiver</li> <li>• Available in Up to Five Popular Finishes: Chrome, Brass, Antique Brass, Brushed Nickel, and Oil Rubbed Bronze</li> </ul> |
|               |               | <b>Cat. No. 701CXX</b><br>Sliding Door Receiver |                                                                                                                                                                                                                                                                                                                           |
|               |               | <b>Cat. No. 703CXX</b><br>Sliding Door Lock     |                                                                                                                                                                                                                                                                                                                           |
|               |               | <b>Cat. No. 704CXX</b><br>Sliding Door Receiver |                                                                                                                                                                                                                                                                                                                           |









# CRL Towel Bars

Material: 19mm Diameter Brass Tubing (1.5mm thick); 31.8mm Diameter Metal Washers

Glass Thickness Range: 6mm to 12mm

Hole Diameter Required: 12mm



| View                                                                                | Cat No. / Description     | Centre-to-Centre Hole |
|-------------------------------------------------------------------------------------|---------------------------|-----------------------|
|    | <b>Cat. No. BM12XX</b>    | 305mm Towel Bar       |
|                                                                                     | <b>Cat. No. BM18XX</b>    | 457mm Towel Bar       |
|                                                                                     | <b>Cat. No. BM20XX</b>    | 508mm Towel Bar       |
|                                                                                     | <b>Cat. No. BM22XX</b>    | 559mm Towel Bar       |
|                                                                                     | <b>Cat. No. BM24XX</b>    | 610mm Towel Bar       |
|                                                                                     | <b>Cat. No. BM26XX</b>    | 660mm Towel Bar       |
|                                                                                     | <b>Cat. No. BM27XX</b>    | 686mm Towel Bar       |
|                                                                                     | <b>Cat. No. BM28XX</b>    | 711mm Towel Bar       |
|                                                                                     | <b>Cat. No. BM30XX</b>    | 762mm Towel Bar       |
|    | <b>Cat. No. BMNW12XX</b>  | 305mm Towel Bar       |
|                                                                                     | <b>Cat. No. BMNW18XX</b>  | 457mm Towel Bar       |
|                                                                                     | <b>Cat. No. BMNW20XX</b>  | 508mm Towel Bar       |
|                                                                                     | <b>Cat. No. BMNW22XX</b>  | 559mm Towel Bar       |
|                                                                                     | <b>Cat. No. BMNW24XX</b>  | 610mm Towel Bar       |
|                                                                                     | <b>Cat. No. BMNW26XX</b>  | 660mm Towel Bar       |
|                                                                                     | <b>Cat. No. BMNW27XX</b>  | 686mm Towel Bar       |
|                                                                                     | <b>Cat. No. BMNW28XX</b>  | 711mm Towel Bar       |
|                                                                                     | <b>Cat. No. BMNW30XX</b>  | 762mm Towel Bar       |
|  | <b>Cat. No. CSH18XX</b>   | 457mm Towel Bar       |
|                                                                                     | <b>Cat. No. CSH24XX</b>   | 610mm Towel Bar       |
|  | <b>Cat. No. SQ18XX</b>    | 457mm Towel Bar       |
|                                                                                     | <b>Cat. No. SQ24XX</b>    | 610mm Towel Bar       |
|  | <b>Cat. No. MT18XX</b>    | 457mm Towel Bar       |
|                                                                                     | <b>Cat. No. MT24XX</b>    | 610mm Towel Bar       |
|  | <b>Cat. No. BM12X12XX</b> | 305mm Towel Bar       |
|                                                                                     | <b>Cat. No. BM18X18XX</b> | 457mm Towel Bar       |
|                                                                                     | <b>Cat. No. BM24X24XX</b> | 610mm Towel Bar       |
|                                                                                     | <b>Cat. No. BM30X30XX</b> | 762mm Towel Bar       |

# CRL Towel Bars

Material: 19mm Diameter Brass Tubing (1.5mm thick); 31.8mm Diameter Metal Washers

Glass Thickness Range: 6mm to 12mm













Hole Diameter Required: 12mm



| View                                                                                                                                 | Cat No. / Description       | Centre-to-Centre Hole        |
|--------------------------------------------------------------------------------------------------------------------------------------|-----------------------------|------------------------------|
|                                                     | Cat. No. <b>BMNW12X12XX</b> | 305mm Towel Bar              |
|                                                                                                                                      | Cat. No. <b>BMNW18X18XX</b> | 457mm Towel Bar              |
|                                                                                                                                      | Cat. No. <b>BMNW24X24XX</b> | 610mm Towel Bar              |
|                                                                                                                                      | Cat. No. <b>BMNW30X30XX</b> | 762mm Towel Bar              |
|                                                     | Cat. No. <b>CSH18X18XX</b>  | 457mm Towel Bar              |
|                                                                                                                                      | Cat. No. <b>CSH24X24XX</b>  | 610mm Towel Bar              |
|                                                    | Cat. No. <b>SQ18X18XX</b>   | 457mm Towel Bar              |
|                                                                                                                                      | Cat. No. <b>SQ24X24XX</b>   | 610mm Towel Bar              |
|                                                   | Cat. No. <b>MT18X18XX</b>   | 457mm Towel Bar              |
|                                                                                                                                      | Cat. No. <b>MT24X24XX</b>   | 610mm Towel Bar              |
|  <p><b>Pull Handle/ Towel Bar Combination</b></p> | Cat. No. <b>BM6X12XX</b>    | 152mm Pull / 305mm Towel Bar |
|                                                                                                                                      | Cat. No. <b>BM6X18XX</b>    | 152mm Pull / 457mm Towel Bar |
|                                                                                                                                      | Cat. No. <b>BM6X22XX</b>    | 152mm Pull / 559mm Towel Bar |
|                                                                                                                                      | Cat. No. <b>BM6X24XX</b>    | 152mm Pull / 610mm Towel Bar |
|                                                                                                                                      | Cat. No. <b>BM8X18XX</b>    | 203mm Pull / 457mm Towel Bar |
|                                                                                                                                      | Cat. No. <b>BM8X20XX</b>    | 203mm Pull / 508mm Towel Bar |
|                                                                                                                                      | Cat. No. <b>BM8X22XX</b>    | 203mm Pull / 457mm Towel Bar |
|                                                                                                                                      | Cat. No. <b>BM8X24XX</b>    | 203mm Pull / 610mm Towel Bar |
|  <p><b>Pull Handle/ Towel Bar Combination</b></p> | Cat. No. <b>BMNW6X12XX</b>  | 152mm Pull / 305mm Towel Bar |
|                                                                                                                                      | Cat. No. <b>BMNW6X18XX</b>  | 152mm Pull / 457mm Towel Bar |
|                                                                                                                                      | Cat. No. <b>BMNW6X22XX</b>  | 152mm Pull / 559mm Towel Bar |
|                                                                                                                                      | Cat. No. <b>BMNW6X24XX</b>  | 152mm Pull / 610mm Towel Bar |
|                                                                                                                                      | Cat. No. <b>BMNW8X18XX</b>  | 203mm Pull / 457mm Towel Bar |
|                                                                                                                                      | Cat. No. <b>BMNW8X22XX</b>  | 203mm Pull / 457mm Towel Bar |
|                                                                                                                                      | Cat. No. <b>BMNW8X24XX</b>  | 203mm Pull / 610mm Towel Bar |
|                                                                                                                                      | Cat. No. <b>BMNW12X24XX</b> | 305mm Pull / 610mm Towel Bar |

# CRL Shower Door Seals



| View                                                                                                                                                                   | Features                                                                                                                                                                                                     | Cat. No. / Description                                                 |
|------------------------------------------------------------------------------------------------------------------------------------------------------------------------|--------------------------------------------------------------------------------------------------------------------------------------------------------------------------------------------------------------|------------------------------------------------------------------------|
|   | <ul style="list-style-type: none"> <li>• Can be used on inswing and outswing doors</li> <li>• 2.49m stock length</li> </ul>                                                                                  | <p><b>Cat. No. PCR8</b><br/>CRL Translucent Vinyl Bulb Seal</p>        |
|   | <ul style="list-style-type: none"> <li>• Can be used on inswing and outswing doors</li> <li>• 2.49m stock length</li> </ul>                                                                                  | <p><b>Cat. No. PCR10</b><br/>CRL Translucent Vinyl Bulb Seal</p>       |
|   | <ul style="list-style-type: none"> <li>• Can be used as bottom sweep, or vertically on bi-fold doors</li> <li>• 2.49m stock length</li> <li>• Snap on application</li> <li>• Can be used two ways</li> </ul> | <p><b>Cat. No. P14WS</b><br/>CRL Dual Durometer PVC Seal and Wipe</p>  |
|   | <ul style="list-style-type: none"> <li>• Can be used as bottom sweep, or vertically on bi-fold doors</li> <li>• 2.49m stock length</li> <li>• Snap on application</li> <li>• Can be used two ways</li> </ul> | <p><b>Cat. No. P770WS</b><br/>CRL Dual Durometer PVC Seal and Wipe</p> |
|   | <ul style="list-style-type: none"> <li>• Can be used as bottom sweep, or vertically on bi-fold doors</li> <li>• 2.49m stock length</li> <li>• Snap on application</li> <li>• Can be used two ways</li> </ul> | <p><b>Cat. No. P880WS</b><br/>CRL Dual Durometer PVC Seal and Wipe</p> |
|   | <ul style="list-style-type: none"> <li>• Can be used as bottom sweep, or vertically on bi-fold doors</li> <li>• 2.49m stock length</li> <li>• Snap on application</li> <li>• Can be used two ways</li> </ul> | <p><b>Cat. No. P120WS</b><br/>CRL Dual Durometer PVC Seal and Wipe</p> |

# CRL Shower Door Seals

| View | Features                                                                                                                                                                                                                    | Glass Thickness                                             | 'X'                          | 'Y'                  | Cat No. / Description                                                                                                                                                                                                                                                            |
|------|-----------------------------------------------------------------------------------------------------------------------------------------------------------------------------------------------------------------------------|-------------------------------------------------------------|------------------------------|----------------------|----------------------------------------------------------------------------------------------------------------------------------------------------------------------------------------------------------------------------------------------------------------------------------|
|      |                                                                                                                                                                                                                             | 6mm<br>8mm<br>10mm<br>12mm                                  | 16mm<br>16mm<br>19mm<br>19mm | -<br>-<br>-<br>-     | <b>Cat. No. P914WS</b> CRL Co-Extruded Bottom Wipe With Drip Rail<br><b>Cat. No. P956WS</b> CRL Co-Extruded Bottom Wipe With Drip Rail<br><b>Cat. No. P990WS</b> CRL Co-Extruded Bottom Wipe With Drip Rail<br><b>Cat. No. P912WS</b> CRL Co-Extruded Bottom Wipe With Drip Rail |
|      |                                                                                                                                                                                                                             | 8mm<br>10mm<br>12mm                                         | 10mm<br>11mm<br>12mm         | -<br>-<br>-          | <b>Cat. No. P450BR</b> CRL Clear Bottom Rail With Translucent Wipe<br><b>Cat. No. P500BR</b> CRL Clear Bottom Rail With Translucent Wipe<br><b>Cat. No. P660BR</b> CRL Clear Bottom Rail With Translucent Wipe                                                                   |
|      |                                                                                                                                                                                                                             | 8mm<br>10mm<br>12mm                                         | 19mm<br>21mm<br>21mm         | 11mm<br>12mm<br>12mm | <b>Cat. No. PCC8</b> CRL "H" Jamb With Soft Leg<br><b>Cat. No. PCC10</b> CRL "H" Jamb With Soft Leg<br><b>Cat. No. PCC12</b> CRL "H" Jamb With Soft Leg                                                                                                                          |
| View | Features                                                                                                                                                                                                                    | Cat No. / Description                                       |                              |                      |                                                                                                                                                                                                                                                                                  |
|      | <ul style="list-style-type: none"><li>• Can be used on inswing and outswing doors</li><li>• Close Gaps from 1.6 to 5mm</li><li>• 2.49m stock length</li><li>• Adheres using silicone only (not very hi-bond tape)</li></ul> | <b>Cat. No. S1LB</b><br>CRL Translucent Silicone Bulb Seal  |                              |                      |                                                                                                                                                                                                                                                                                  |
|      | <ul style="list-style-type: none"><li>• Pre-applied VHB tape for easy installation</li><li>• Labour savings due to pre-application of tape</li><li>• Stocked in 2.49m lengths</li></ul>                                     | <b>Cat. No. SDTJT2</b><br>CRL SDTB with Pre-Applied Tape    |                              |                      |                                                                                                                                                                                                                                                                                  |
|      | <ul style="list-style-type: none"><li>• Pre-applied tape for easy installation</li><li>• Labour savings due to pre-application of tape</li><li>• Stocked in 2.49m lengths</li></ul>                                         | <b>Cat. No. SDTBT2</b><br>CRL Deep U-Channel for 10mm Glass |                              |                      |                                                                                                                                                                                                                                                                                  |
|      | <ul style="list-style-type: none"><li>• Pre-applied VHB tape for easy installation</li><li>• Labour savings due to pre-application of tape</li><li>• Stocked in 2.49m lengths</li></ul>                                     | <b>Cat. No. SDTDFT2</b><br>CRL SDTDF with Pre-Applied Tape  |                              |                      |                                                                                                                                                                                                                                                                                  |
|      | <ul style="list-style-type: none"><li>• Pre-applied tape for easy installation</li><li>• Labour savings due to pre-application of tape</li><li>• Stocked in 2.49m lengths</li></ul>                                         | <b>Cat. No. SDTNLT2</b><br>CRL SDTNL with Pre-Applied Tape  |                              |                      |                                                                                                                                                                                                                                                                                  |
|      | <ul style="list-style-type: none"><li>• Pre-applied high-bond tape for easy installation</li><li>• Labour savings due to pre-application of tape</li><li>• Stocked in 2.49m lengths</li></ul>                               | <b>Cat. No. SDTLT2</b><br>CRL SDTL with Pre-Applied Tape    |                              |                      |                                                                                                                                                                                                                                                                                  |
|      | <ul style="list-style-type: none"><li>• Pre-applied high-bond tape for easy installation</li><li>• Labour savings due to pre-application of tape</li><li>• Stocked in 2.49m lengths</li></ul>                               | <b>Cat. No. SDTST2</b><br>CRL SDTS with Pre-Applied Tape    |                              |                      |                                                                                                                                                                                                                                                                                  |
|      | <ul style="list-style-type: none"><li>• Pre-applied tape for easy installation</li><li>• Labour savings due to pre-application of tape</li><li>• Stocked in 2.49m lengths</li></ul>                                         | <b>Cat. No. SDTWT2</b><br>CRL SDTW with Pre-Applied Tape    |                              |                      |                                                                                                                                                                                                                                                                                  |



# Create the perfect bathroom

with CRL's huge range of Shower Hardware and accessories, from installation to maintenance.



View

Cat. No. / Description



**Cat. No. EB1701**  
CRL Spray Glass Cleaner

View

Cat. No. / Description

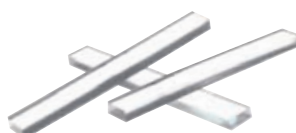

**Cat. No. PSB040**  
CRL Clear Plastic Setting Blocks



**Cat. No. EWCW1**  
CRL Cleret Elite Squeegee



**Cat. No. 16351**  
CRL E-Z Mount Mirror Clip Sets

View Cat No. / Description



**Cat. No. NDC4XX**  
No-Drill Fixed Panel Clamp



**Cat. No. 31M8010XX**  
180° Wall Mount Hinge  
Hold Open  
Hydraulic Self -Close



**Cat. No. 31M8015XX**  
180° Glass-To-Glass Hinge  
Hold Open  
Hydraulic Self -Close



**Cat. No. 31M8060XX**  
One Way Swinging Wall Mount Hinge  
Hold Open  
Hydraulic Self -Close

**Ideal for saunas  
and steam rooms**



**Cat. No. 7020MP - 7050MP**  
CRL Heated Mirror Pads



**Cat. No. D645BA**  
CRL Brite Anodised Nose Aluminum "J" Channel



**Cat. No. 1631A**  
CRL Chrome Plated Dome Head No 8 Gauge Steel Screws



**Cat. No. DL631XX**  
CRL Adjustable Shelf Brackets



**Cat. No. PC6100**  
CRL 6K Surface Protector - Pre Clean 1 litre  
**Cat. No. NS6100**  
CRL 6K Surface Protector - Protect 1 litre

View Cat No. / Description



**Cat. No. 17600**  
CRL Chrome Deluxe Shower Squeegee



**Cat. No. S0RH1XX**  
CRL Polished Chrome Designer Series Sleeve-Over Robe Hook



**Cat. No. WSR1**  
CRL Bio-Clean Water Stain Remover



**Cat. No. EU33SC**  
CRL Clear Acetic Cure Silicone Sealant  
(Also available in black or white)



**Cat. No. EURTV408C**  
CRL Clear Neutral Cure Silicone Sealant  
(Also available in black or white)



**Cat. No. WCS1**  
CRL Water Clear Silicone



**Cat. No. EUCCS**  
CRL Crystal Clear Silicone Sealant



**Cat. No. EG310**  
CRL evergrip™ Mirror Adhesive Tubes



**Cat. No. GN100E**  
CRL Gunther Ultra/Bond Mirror Mastic

# Colour range\*

All CRL Frameless Shower Door products are available in a variety of beautiful stock finish to enhance the décor of the surrounding environments. Add the chosen colour code to a Cat No to complete your product code.

Note: Not all Finishes are available for every product, please call or consult [crlaurence.co.uk](http://crlaurence.co.uk) for product specific colour options.

|                                    |                                   |                                    |                               |
|------------------------------------|-----------------------------------|------------------------------------|-------------------------------|
|                                    |                                   |                                    |                               |
| <b>CH</b> Chrome                   | <b>SC</b> Satin Chrome (Matte)    | <b>BSC</b> Brushed Satin Chrome    | <b>BR</b> Brass               |
|                                    |                                   |                                    |                               |
| <b>SB</b> Satin Brass              | <b>UBR</b> Ultra Brass            | <b>ABR</b> Antique Brass           | <b>BN</b> Brushed Nickel      |
|                                    |                                   |                                    |                               |
| <b>PN</b> Polished Nickel          | <b>SN</b> Satin Nickel            | <b>ABN</b> Antique Brushed Nickel  | <b>ORB</b> Oil Rubbed Bronze  |
|                                    |                                   |                                    |                               |
| <b>ABRZ</b> Antique Bronze         | <b>BBRZ</b> Brushed Bronze        | <b>BCO</b> Brushed Copper          | <b>PCO</b> Polished Copper    |
|                                    |                                   |                                    |                               |
| <b>ABCO</b> Antique Brushed Copper | <b>GP</b> Gold Plated             | <b>GM</b> Gun Metal                | <b>W</b> White                |
|                                    |                                   |                                    |                               |
| <b>BL</b> Black                    | <b>BS</b> Brushed Stainless Steel | <b>PS</b> Polished Stainless Steel | <b>CBA</b> Chrome/Brass Steel |

\* The finishes shown are as close as possible to the actual item. Some images might look a little different when compared to the actual product.

# Colour range

See our range of colour finishes overleaf. Keep the flap open for easy reference.

Call FREE on 00 800 0421 6144

Fax FREE on 00 800 0262 3299



#### Manchester

Charles Babbage Avenue  
Kingsway Business Park,  
Rochdale, OL16 4NW, England  
Tel: +44 (0) 1706 863 600  
Fax: +44 (0) 1706 869 860  
[www.crlaurence.co.uk](http://www.crlaurence.co.uk)



#### Stuttgart

Boschstrasse 7  
D-74360 Ilfeld  
Germany  
Tel: +49 (0) 7062 915 93 15  
Fax: +49 (0) 7062 915 93 16  
[www.crlaurence.de](http://www.crlaurence.de)



#### Copenhagen

Stamholmen 70 Unit B,  
DK-2650 Hvidovre  
Denmark  
Tel: +45 36 72 09 00  
Fax: +45 36 70 33 35  
[www.crlaurence.dk](http://www.crlaurence.dk)



#### France

Boschstrasse 7  
D-74360 Ilfeld  
Germany  
Tel: +49 (0) 7062 915 93 15  
Fax: +49 (0) 7062 915 93 16  
[www.crlaurence.fr](http://www.crlaurence.fr)

**CNL**  
[crlaurence.co.uk](http://crlaurence.co.uk)



View Our Full Range of  
Frameless Shower Door Hardware  
and Supplies...

Our EUSD12 Frameless Shower Door Hardware  
and Supplies Catalogue

- Hinges
- Pull Handles
- Knobs
- Towel Bars
- Clamps
- Headers
- U-Channels
- Tapes
- Wipes
- Door Kits

You may also be interested in...

EUAH11 Architectural Hardware  
'All Glass' Entrance Systems Catalogue

- Architectural Metals
- Door and Sidelite Rails
- Door Closers
- Centre Locks
- Glass Clamps
- Headers and Channels
- Ladder Pulls
- Locking Hardware
- Door Closers and Hinges
- Patch Hardware
- Pivot Door Systems
- Push/Pull Handles
- Sliding and Stacking Glass Door Systems
- Spider Fittings
- Standoff Systems

Catalogues are available to download  
or view online at [crlaurence.co.uk](http://crlaurence.co.uk)  
or [crlaurence.de](http://crlaurence.de)

# Sliding Door Systems

for Glass

Beautiful, easy to install systems





A modern kitchen and dining area featuring a glass partition system. The kitchen has dark wood cabinets and a stainless steel refrigerator. The dining table is glass with metal legs and four white chairs. The glass partition is frosted and has a metal frame. The ceiling has recessed lighting.

**Beautiful,  
easy to install  
systems...**



## **CRL has a fantastic range of Sliding Door Hardware to suit a variety of glass door applications.**

The range consists of beautiful, easy to install systems, including the CRL280 series Top Hung Sliding Door System, the most versatile system of its kind. There are six different CRL280 kits to choose from, offering configurations with or without fixed panels, and the ability to mount either to the wall, ceiling or glass panels.

A great addition to the range is the new CRL50 and CRL70 Series Top Hung Sliding Door Systems which feature a sleek design that offers options for wall or ceiling mount for sliding glass doors with or without fixed panels. These top hung systems require no bottom track and the smooth sliding action allows for finger touch control.

For heavier glass door applications we have the GSDH Series Bottom Rolling Door System which features a unique design that gives the door the appearance that it is gliding on air. The top guide track mounts to the wall and provides for secure and smooth operation of the rolling panel. The GSDH Bottom Rolling System is a great alternative when the building structure cannot carry the load of a top hung system.

Further to CRL280, CRL50, CRL70 and GSDH Series we also feature the popular Laguna series and EZ – Slide Top Hung Single Track Sliding Door System for 10 and 12mm toughened glass within this brochure.

Our Sliding Door Hardware brochure only shows a small collection of products from our huge Architectural Door Hardware range, including Door Rails, Patch Fittings, Floor Springs, Handles and much more. For further details please view our EUAH11 catalogue online or request a hard copy.

**NEW** gentle door closing systems - see pages 15 & 18

**CRL**<sup>®</sup>  
crlaurence.co.uk

For more information call FREE on  
**00 800 0421 6144**

e: [CRL@crlaurence.co.uk](mailto:CRL@crlaurence.co.uk) f: 00 800 0262 3299

# CRL280 Series Top Hung Sliding Door System



- Sleek design
- No notches or holes required in the glass for installation
- Designed for use with 8, 10, or 12mm toughened glass
- Rated for doors weighing up to 80kg

The new CRL280 series Top Hung Sliding Door System is truly the most versatile system of its kind. There are six different kits to choose from, offering configurations with or without fixed panels, and the ability to mount either to the wall, ceiling or glass panels.

The CRL280 System has no bottom track, so a tripping hazard is eliminated, and the smooth sliding action allows for finger touch control. The upper clamp and roller assemblies have a fine tune adjustment feature allowing for openings and floors that are not true and level. Each kit comes with concealed stops in the top track to hold the door open or closed.

Kits are available in a satin anodised finish, with a special order option to clad or powder paint in any architectural finish desired.

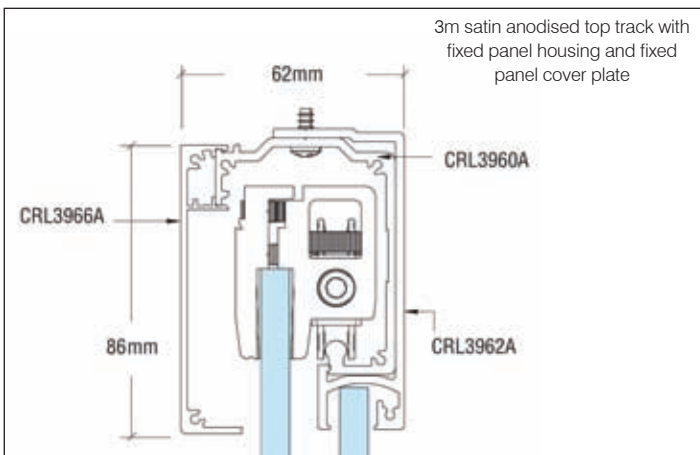
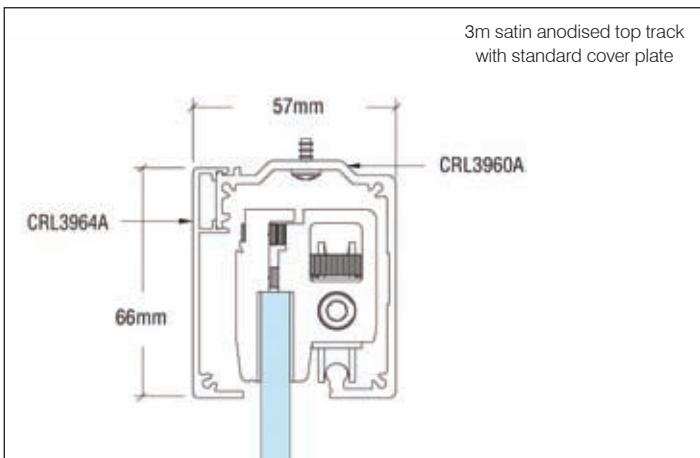

## Available CRL280 Kits

- Kits contain all necessary hardware to complete the Installation
- Rollers have up to 6mm of vertical adjustment to aid in door alignment after installation
- Satin anodised finish

There are three configurations of CRL280 Series Kits. All come with everything you need (except the toughened glass) to complete the installation. Kits are available in a satin anodised finish, with a special order option to clad or powder paint in any architectural finish desired. Contact technical sales for commercial products for kit selection or installation assistance.

**NOTE:** Laminated glass should not be used with the CRL280 Series.

### SINGLE SLIDING DOOR KITS FOR 8 TO 10MM TOUGHENED GLASS

| CAT. NO.        | KIT DESCRIPTION                                                         |
|-----------------|-------------------------------------------------------------------------|
| <b>CRL2810</b>  | Single sliding door wall or ceiling mount installation                  |
| <b>CRL2810F</b> | Single sliding door with fixed panel wall or ceiling mount installation |
| <b>CRL2810G</b> | Single sliding door glass fixed panel mount installation                |

### SINGLE SLIDING DOOR KITS FOR 12MM TOUGHENED GLASS

| CAT. NO.        | KIT DESCRIPTION                                                         |
|-----------------|-------------------------------------------------------------------------|
| <b>CRL2812</b>  | Single sliding door wall or ceiling mount installation                  |
| <b>CRL2812F</b> | Single sliding door with fixed panel wall or ceiling mount installation |
| <b>CRL2812G</b> | Single sliding door glass fixed panel mount installation                |

Minimum order: 1 each. Kits contain stock lengths of Top Track measuring 3m in length, and therefore must ship common carrier. Kits can be combined for quantity pricing.

## CRL2810/CRL2812 Top Hung Sliding Door Installation Assembly



- Satin anodised finish
- For use with 8, 10 or 12mm toughened glass
- 3m top track

The CRL2810/CRL2812 Top Hung Sliding Door Installation Assembly contains all of the components you will need (except the toughened glass) to complete this style of installation.

This model can accommodate a single door weighing up to 80kg, with a maximum width of 1.5m.

## CRL2810F/CRL2812F Top Hung Sliding Door Installation Assembly



- Satin anodised finish
- For use with 8, 10 or 12mm toughened glass
- 3m top track and fixed glass channel

The CRL2810F/CRL2812F Top Hung Sliding Door Installation Assembly contains all of the components you will need (except the toughened glass) to complete this style of installation.

This model can accommodate a single door weighing up to 80kg, with a maximum width of 1.5m, plus a fixed glass panel of desired width.

## CRL2810G/CRL2812G Top Hung Sliding Door Installation Assembly



- Ideal for glass walls
- Satin anodised finish
- For use with 8, 10 or 12mm toughened glass
- 3m top track
- Mounts to fixed glass panel

The CRL2810G/CRL2812G Top Hung Sliding Door Installation Assembly contains all of the components you will need (except the toughened glass) to complete this style of installation.

This model is designed to mount a 10 or 12mm fixed glass panel. It can accommodate a single door weighing up to 80kg, with a maximum width of 1.5m.



**CRL50**





# CRL50 Series Top Hung Sliding Door Systems



- Models for single doors, synchronized doors, and telescoping doors
- For use with 8 or 10mm toughened glass
- No notches or holes required in the glass
- Mounts to wall or ceiling
- Can accommodate doors weighing up to 80kg

The new CRL50 Series Top Hung Sliding Door Systems feature a sleek design that offers options for wall or ceiling mount for sliding glass doors with or without fixed panels. These top hung systems require no bottom track and the smooth sliding action allows for finger touch control.

The upper clamp and roller assemblies offer 6mm of height adjustment during installation to allow for openings and floors that are not true and level. Kits come with concealed roller stops in the top track to hold the door in the open or closed position, a small bottom guide, and are available in a satin anodised finish with an option for powder paint or cladding in any architectural finish desired.

CRL50 Systems are also available with optional 'synchronization' of bi-parting doors where the operation of one panel moves the others. A 'telescoping' option is also available where the panels slide in the same direction and stack away together. You can also enjoy the best of both with our combination 'synchronized' and 'telescoping' options all in one.

Contact technical sales for commercial products for assistance with proper kit selection or installation instruction assistance.

**NOTE:** Laminated glass should not be used with the CRL50 System.

## CRL50 Series Wall Mount Single Kits

**NEW** softbrake gentle door closing system for the CRL50 Series - see page 15

- Kits contain all necessary hardware to complete the installation
- Satin anodised finish

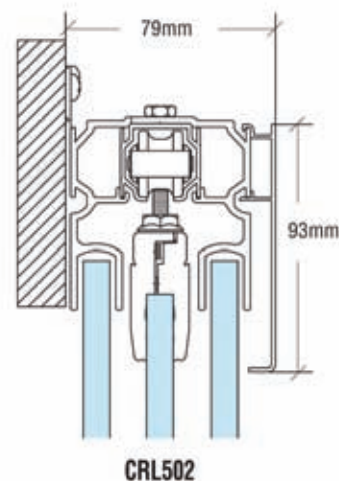
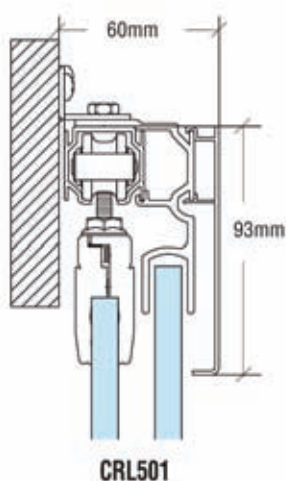
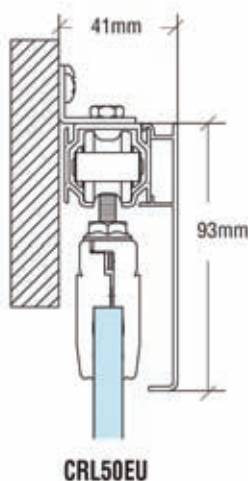

There are three configurations of CRL50 Series Kits for single glass doors mounting to walls. All come with everything you need (except the toughened glass) to complete the installation. Kits are available in a satin anodised finish, with an option for powder paint or cladding in any architectural finish desired.

### CRL50 SERIES WALL MOUNT KITS

| CAT. NO.      | KIT DESCRIPTION                           |
|---------------|-------------------------------------------|
| <b>CRL50</b>  | Single sliding door                       |
| <b>CRL501</b> | Single sliding door with fixed panel      |
| <b>CRL502</b> | Single sliding door with two fixed panels |

Minimum order: 1 each. Kits contain stock lengths of Top Track measuring 3m in length, and therefore must ship common carrier. Kits can be combined for quantity pricing.

## CRL50 Series Structural Ceiling Mount Single Kits

- For installation to structural ceilings
- Satin anodised finish

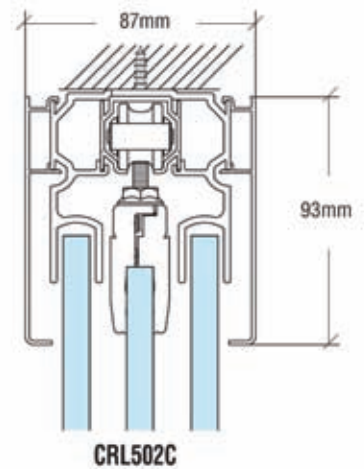
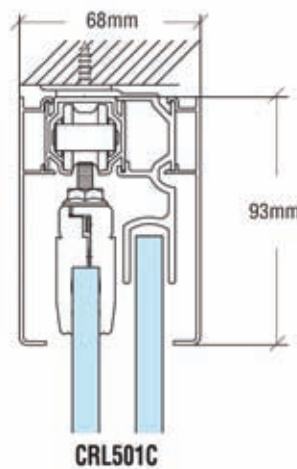
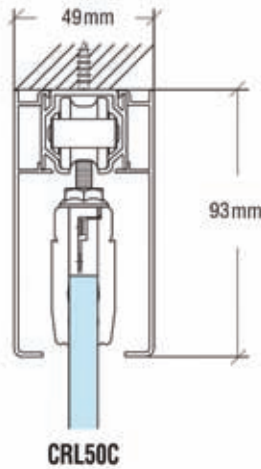

There are three configurations of CRL50 Series Kits for single glass doors mounting to a structural ceiling. All come with everything you need (except the toughened glass) to complete the installation. Kits are available in a satin anodised finish, with an option for powder paint or cladding in any architectural finish desired.

### CRL50 SERIES STRUCTURAL CEILING MOUNT KITS

| CAT. NO. | KIT DESCRIPTION                           |
|----------|-------------------------------------------|
| CRL50C   | Single sliding door                       |
| CRL501C  | Single sliding door with fixed panel      |
| CRL502C  | Single sliding door with two fixed panels |

Minimum order: 1 each. Kits contain stock lengths of Top Track measuring 3m in length, and therefore must ship common carrier. Kits can be combined for quantity pricing.

## CRL50 Series Dropped Ceiling Mount Single Kits

- For installation into dropped ceilings
- Satin anodised finish

There are two configurations of CRL50 Series Kits for single glass doors used with dropped ceilings. Each kit comes with everything you need (except the toughened glass) to complete the installation. Kits are available in a satin anodised finish, with an option for powder paint or cladding in any architectural finish desired. The Top Patches can be covered to create the 'full rail' look. Covers are available in bright aluminium, satin anodised, and white painted finishes and are ordered separately.

**NOTE:** Structural support (not included, by others) is also required when using the dropped ceiling tracks. Fasteners not included.

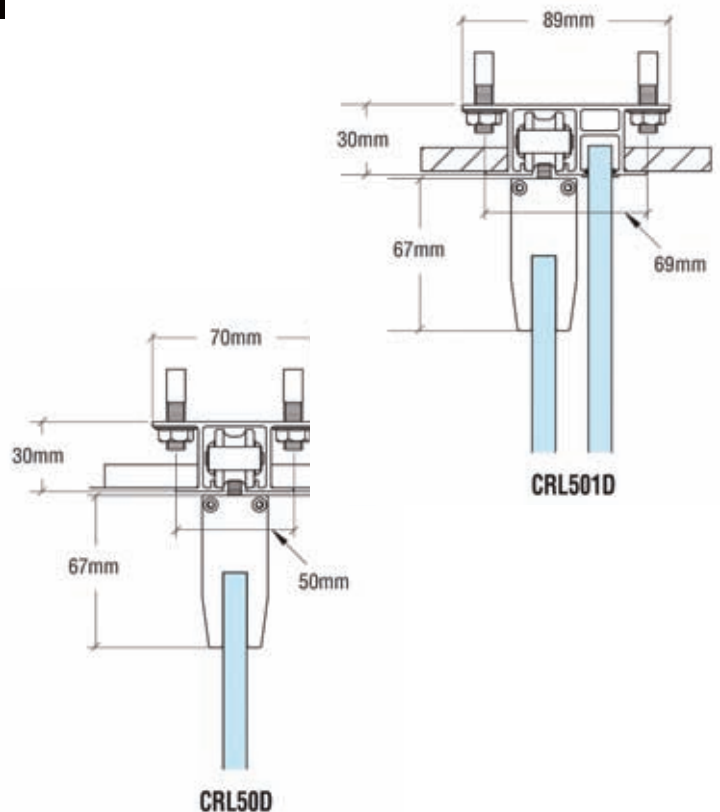

### CRL50 SERIES DROPPED CEILING MOUNT KITS

| CAT. NO. | KIT DESCRIPTION                      |
|----------|--------------------------------------|
| CRL50D   | Single sliding door                  |
| CRL501D  | Single sliding door with fixed panel |

Minimum order: 1 each. Kits contain stock lengths of Top Track measuring 3m in length, and therefore must ship common carrier. Kits can be combined for quantity pricing.



# CRL50 Series Kits for Synchronised Doors



- Synchronized operation of two bi-parting panels
- Rollers have up to 6mm of vertical adjustment to aid in door alignment
- Wall and ceiling mount models available
- Satin anodised finish

There are four configurations of CRL50 Series Kits for synchronized 8 to 10mm toughened glass doors. These Kits provide synchronized movement of two glass bi-parting panels while only operating one of the panels. All Kits come with everything you need (except the toughened glass) to complete the installation. Kits are available in a satin anodised finish, with an option for powder paint or cladding in any architectural finish desired.

Contact technical sales for commercial products for kit selection or installation assistance.

**NOTE:** Laminated glass should not be used with the CRL50 System.

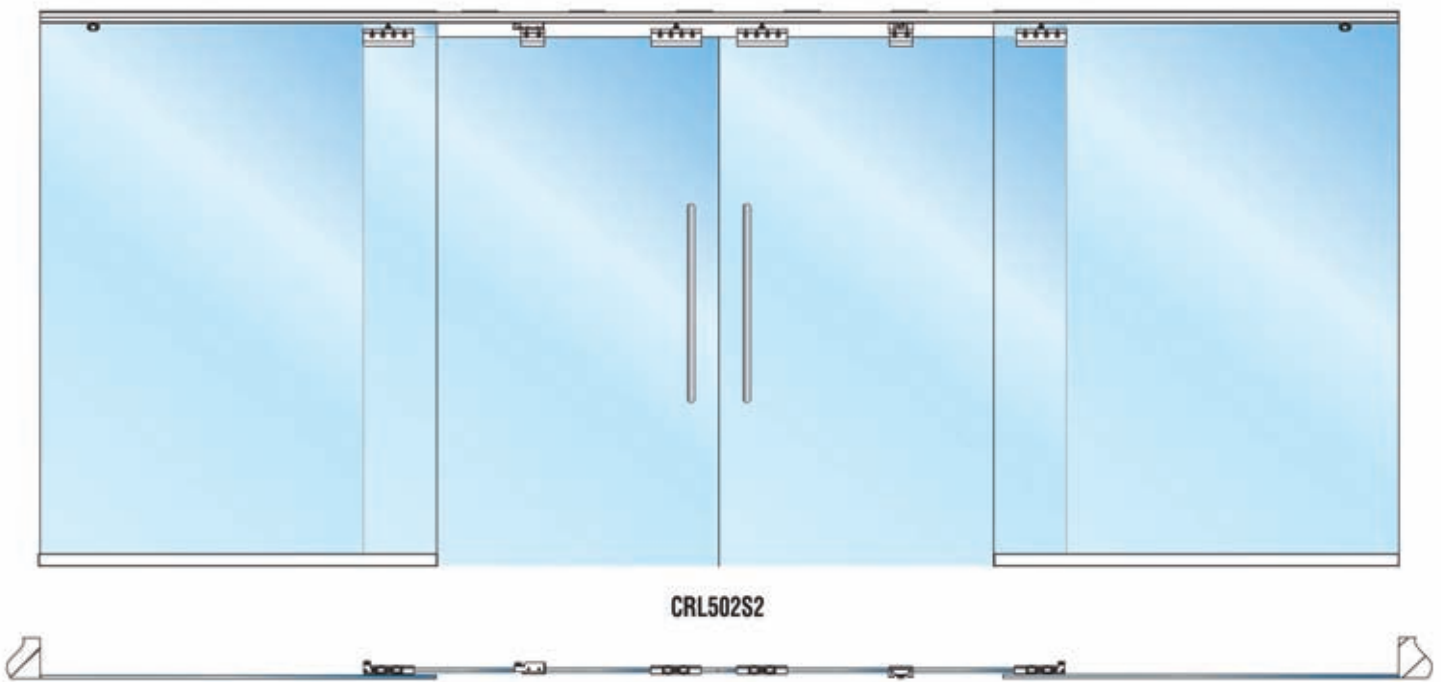

## CRL50 SERIES SYNCHRONIZED WALL MOUNT KITS

| CAT. NO. | KIT DESCRIPTION                  |
|----------|----------------------------------|
| CRL50S2  | Bi-parting                       |
| CRL502S2 | Bi-parting with two fixed panels |

Minimum order: 1 each. Kits contain stock lengths of Top Track measuring 3m in length, and therefore must ship common carrier. Kits can be combined for quantity pricing.

## CRL50 SERIES SYNCHRONIZED CEILING MOUNT KITS

| CAT. NO.  | KIT DESCRIPTION                  |
|-----------|----------------------------------|
| CRL50CS2  | Bi-parting                       |
| CRL502CS2 | Bi-parting with two fixed panels |

Minimum order: 1 each. Kits contain stock lengths of Top Track measuring 3m in length, and therefore must ship common carrier. Kits can be combined for quantity pricing.

# CRL50 Series Kits for Synchronized and Telescoping Doors



- Synchronized and telescoping operation in one kit
- Wall and ceiling mount models available
- Satin anodised finish

CRL offers two configurations of CRL50 Series Kits for synchronized and telescoping 8 to 10mm toughened glass doors. These Kits provide the best of both worlds, synchronized and telescoping operation in a four panel opening, where pairs of panels bi-part and stack away. They come with everything you need (except the toughened glass) to complete the installation. Kits are available in a satin anodised finish, with an option for powder paint or cladding in any architectural finish desired. Contact technical sales for commercial products for kit selection or installation assistance.

**NOTE:** Laminated glass should not be used with the CRL50 System.

### CRL50 SERIES SYNCHRONIZED AND TELESCOPING KITS

| CAT. NO.   | MOUNT   | KIT DESCRIPTION                                         |
|------------|---------|---------------------------------------------------------|
| CRL502SP2  | Wall    | Four panel bi-parting / telescoping behind fixed panels |
| CRL502CSP2 | Ceiling | Four panel bi-parting / telescoping behind fixed panels |

Minimum order: 1 each. Kits contain stock lengths of Top Track measuring 3m in length, and therefore must ship common carrier. Kits can be combined for quantity pricing.

# CRL50 Series Kits for Telescoping Doors

- Telescoping operation
- Wall and ceiling mount models available
- Kits contain all necessary hardware to complete the installation
- Satin anodised finish

There are eight configurations of CRL50 Series Kits for telescoping 8 to 10mm toughened glass doors. These Kits provide telescoping operation where two panels slide in the same direction and stack away together. All come with everything you need (except the toughened glass) to complete the installation. Kits are available in a satin anodised finish, with an option for powder paint or cladding in any architectural finish desired. Contact technical sales for commercial products for kit selection or installation assistance.

**NOTE:** Laminated glass should not be used with the CRL50 System.

### CRL50 SERIES TELESCOPING WALL MOUNT KITS

| CAT. NO.  | STACKING DIRECTION* | KIT DIRECTION                            |
|-----------|---------------------|------------------------------------------|
| CRL50P2R  | Right               | Two panel telescoping                    |
| CRL50P2L  | Left                | Two panel telescoping                    |
| CRL501P2R | Right               | Two panel telescoping behind fixed panel |
| CRL501P2L | Left                | Two panel telescoping behind fixed panel |

Minimum order: 1 each. Kits contain stock lengths of Top Track measuring 3m in length, and therefore must ship common carrier. Kits can be combined for quantity pricing. \*Stacking Direction is determined from the exterior looking in.

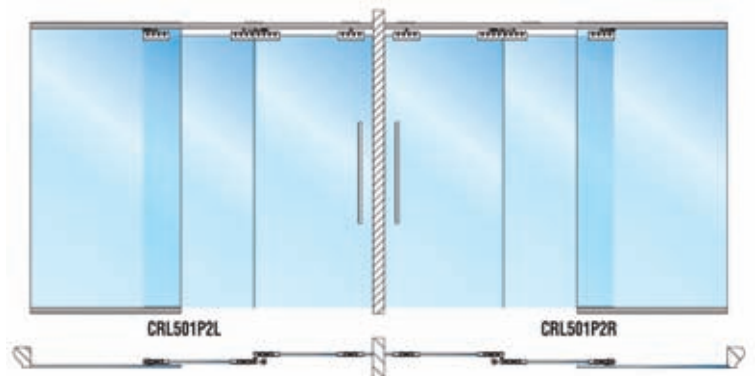

### CRL50 SERIES TELESCOPING CEILING MOUNT KITS

| CAT. NO.   | STACKING DIRECTION* | KIT DIRECTION                            |
|------------|---------------------|------------------------------------------|
| CRL50CP2R  | Right               | Two panel telescoping                    |
| CRL50CP2L  | Left                | Two panel telescoping                    |
| CRL501CP2R | Right               | Two panel telescoping behind fixed panel |
| CRL501CP2L | Left                | Two panel telescoping behind fixed panel |

Minimum order: 1 each. Kits contain stock lengths of Top Track measuring 3m in length, and therefore must ship common carrier. Kits can be combined for quantity pricing. \*Stacking Direction is determined from the exterior looking in.

# CRL70 Series Top Hung Sliding Door Systems



- For use with 8 or 10mm toughened glass or wood doors
- No notches or holes required in the glass
- Mounts to wall or ceiling
- Can accommodate doors weighing up to 125kg

CRL70 Series Top Hung Sliding Door Systems feature a sleek European design that offers options for wall or ceiling mount for sliding glass or wood doors with or without fixed panels. These top hung systems require no bottom track and the smooth sliding action allows for finger touch control. The Upper Clamp and Roller Assemblies offer 6mm of height adjustment during installation to allow for openings and floors that are not true and level. Kits come with concealed roller stops in the top track to hold the door in the open or closed position, a small bottom guide, and are available in a satin anodised finish, with an option for powder paint or cladding in any architectural finish desired.

Contact technical sales for commercial products for assistance with proper kit selection or installation instruction assistance.

**NOTE:** Laminated glass should not be used with the CRL70 System.

## CRL70 Series Kits for Glass Doors

- Kits contain all necessary hardware to complete the installation
- Satin anodised finish
- Wall mount and ceiling mount options

There are six configurations of CRL70 Series Kits for single glass doors. All come with everything you need (except the toughened glass) to complete the installation. Kits are available in a satin anodised finish, with an option for powder paint or cladding in any architectural finish desired.

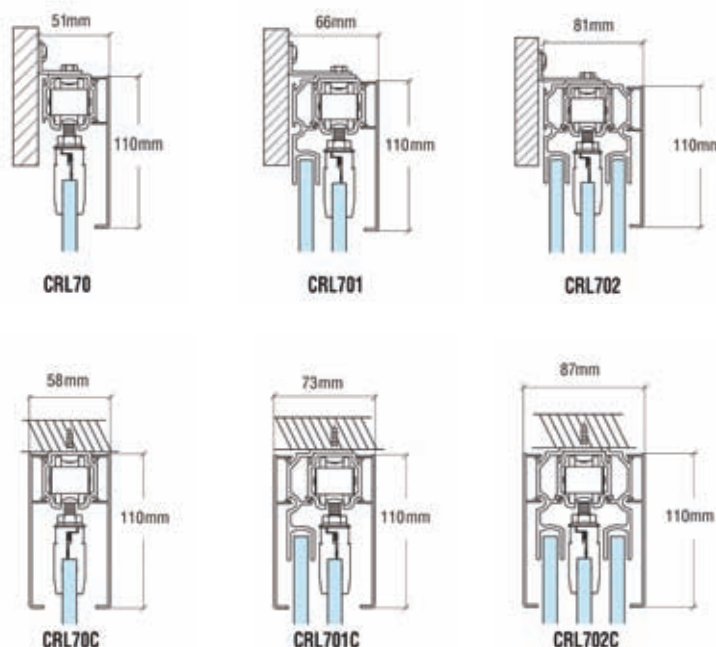

### CRL70 SERIES WALL MOUNT KITS

| CAT. NO.      | KIT DESCRIPTION                           |
|---------------|-------------------------------------------|
| <b>CRL70</b>  | Single sliding door                       |
| <b>CRL701</b> | Single sliding door with fixed panel      |
| <b>CRL702</b> | Single sliding door with two fixed panels |

Minimum order: 1 each. Kits contain stock lengths of Top Track measuring 3m in length, and therefore must ship common carrier. Kits can be combined for quantity pricing.

### CRL70 SERIES CEILING MOUNT KITS

| CAT. NO.       | KIT DESCRIPTION                           |
|----------------|-------------------------------------------|
| <b>CRL70C</b>  | Single sliding door                       |
| <b>CRL701C</b> | Single sliding door with fixed panel      |
| <b>CRL702C</b> | Single sliding door with two fixed panels |

Minimum order: 1 each. Kits contain stock lengths of Top Track measuring 3m in length, and therefore must ship common carrier. Kits can be combined for quantity pricing.



## CRL70 Series Kits for Wood Doors



- Mounts to wall or ceiling
- Top hanger is mortised into the door

The CRL70 Series Kits for Wood Doors come complete with everything you need (except the wood door) to complete the installation. If needed, Cat. No. CRL3990 top track trim cover supports can be ordered separately to provide a means of attachment for customer supplied covers (see below).

**NOTE:** Quantity required to be determined by customer based on cover design.

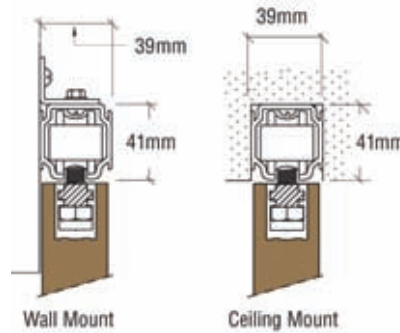

### CRL70 SERIES KITS FOR WOOD DOORS

| CAT. NO.      | KIT DESCRIPTION                           |
|---------------|-------------------------------------------|
| <b>CRL70W</b> | Single sliding door wall or ceiling mount |

Minimum order: 1 each. Kits contain stock lengths of Top Track measuring 3m in length, and therefore must ship common carrier. Kits can be combined for quantity pricing.

## CRL50/70 Series Top Hung Sliding Door System Accessories



### CRL50 Glass Clamp Cover End Caps

CRL70 Glass Clamp Cover End Caps finish off the ends of the glass clamp covers, completing the full rail look. Gray finish, one per package.



#### CRL50 GLASS CLAMP COVER END CAPS

| CAT. NO.       | FINISH | DESCRIPTION    |
|----------------|--------|----------------|
| <b>CRL3948</b> | Grey   | For 8mm Glass  |
| <b>CRL3949</b> | Grey   | For 10mm Glass |

Minimum order: 1 each.

### CRL50 Glass Clamp Covers

CRL50 Glass Clamp Covers are used to create a full rail look on only the CRL50 Series for dropped ceiling systems. They simply snap over the glass clamps and are finished off with end caps that are ordered separately.



#### CRL50 GLASS CLAMP COVERS

| CAT. NO.         | FINISHES         | LENGTH |
|------------------|------------------|--------|
| <b>CRL3947W</b>  | White            | 3m     |
| <b>CRL3947BA</b> | Bright aluminium | 3m     |
| <b>CRL3947SA</b> | Satin anodised   | 3m     |

Minimum order is one stock length. Must ship common carrier.

### CRL50 / 70 Top Track Trim Cover Support

This Steel Trim Cover Support clamps onto sides of top track or fixed panel adaptor to provide attachment of customer supplied covers. Fasteners for covers not included.



#### CRL50 / 70 TOP TRACK TRIM COVER SUPPORT

| CAT. NO.       | KIT DESCRIPTION              |
|----------------|------------------------------|
| <b>CRL3990</b> | Top track trim cover support |

Minimum order: 1 each.

### CRL50 Synchronizing Hardware Set

- For 8 to 10mm toughened glass doors

The CRL50 Synchronizing Hardware Set for glass doors is used in conjunction with either single or telescoping models. It comes complete with all the hardware needed to synchronize an opening of multiple panels while only moving one.

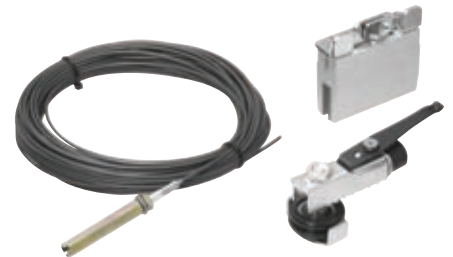

#### CRL50 SYNCHRONIZING HARDWARE SET

| CAT. NO.       | DESCRIPTION                                 |
|----------------|---------------------------------------------|
| <b>CRL3985</b> | Two clamps, two roller stops, and one cable |

Minimum order: 1 set.





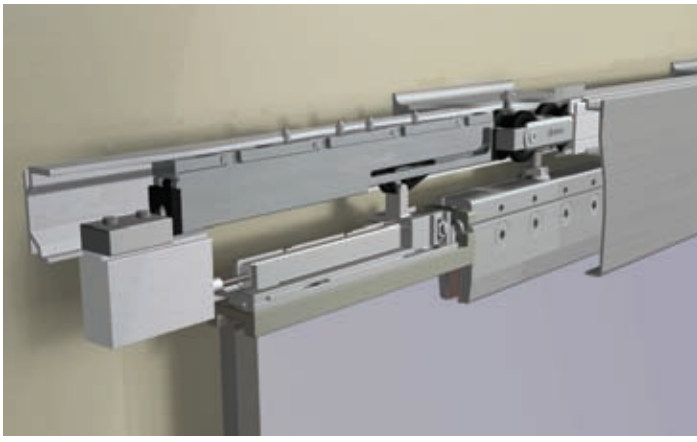

**CRL has launched the new Softbrake braking system for glass panels.**

The Softbrake is a braking system that cushions the opening and/or closing of glass doors gently and quietly. Its main advantage is that it acts during the final 100mm of travel to prevent the glass from impacting against the frame. The application can be fitted in guides mounted on walls or between partitions.

There are two versions, depending on customer requirements:

- The simple Softbrake, with a damping brake for door closing.
- The double Softbrake, with brakes on both sides for damping door opening and closing.

The Softbrake braking system can be applied to CRL's 50 system and is suitable for panels of 8 - 10mm thick glass weighing up to 80kg, with a vertical adjustment of up to 15mm and a horizontal adjustment of up to 6mm.

These softbrake systems are compatible with our CRL50 family and have the following characteristics:

- Up to 80kg maximum
- 8 to 10mm glass

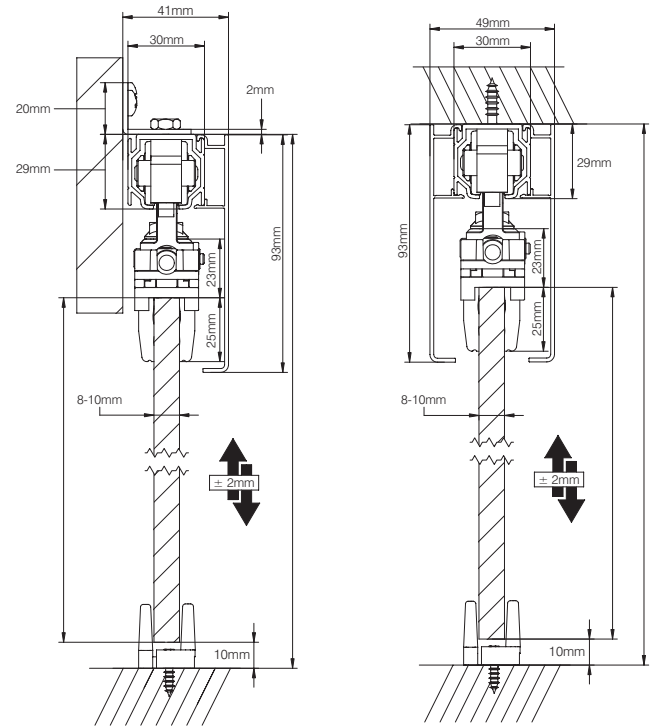

**Single Side Softbrake for 1 door**

**Each Kit Contains**

- 1 standard stopper
- 1 floor guide
- 1 full softbrake (all components needed)
- 1 adjusting key
- Screws



**Double Side Softbrake for 1 door**

**Each Kit Contains**

- 2 clamps with rollers
- 1 floor guide
- 2 full softbrake (all components needed)
- 1 adjusting key
- Screws

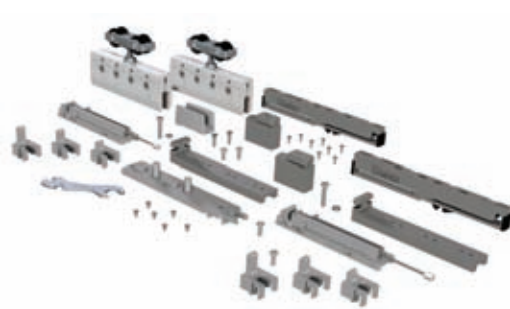

| CAT. NO.  | KIT DESCRIPTION           |
|-----------|---------------------------|
| CRL286780 | Single Side Softbrake Kit |

Minimum order: 1 kit.

| CAT. NO.  | KIT DESCRIPTION           |
|-----------|---------------------------|
| CRL286781 | Double Side Softbrake Kit |

Minimum order: 1 kit.

# CRL GSDH Series Bottom Rolling Door System



- Bottom rolling design for use with 8, 10 or 12mm toughened glass
- Top guide track mounts to wall
- Can accommodate doors weighing up to 130kg
- Brushed or polished stainless steel finishes

The GSDH Series Bottom Rolling Door System features a unique design that gives the door the appearance that it is gliding on air. The top guide track mounts to the wall and provides for secure and smooth operation of the rolling panel.

The GSDH Bottom Rolling System is a great alternative when the building structure cannot carry the load of a top hung system. Each kit comes with concealed stops in the top track to control the length of travel of the door in the open or closed position. Everything is properly balanced to offer a smooth rolling action with finger touch control.

Kits are available in brushed or polished stainless steel finishes, and are intended for use with 8, 10 or 12mm toughened glass. Individual components can also be ordered to customize the opening.

## Available GSDH Series Kits

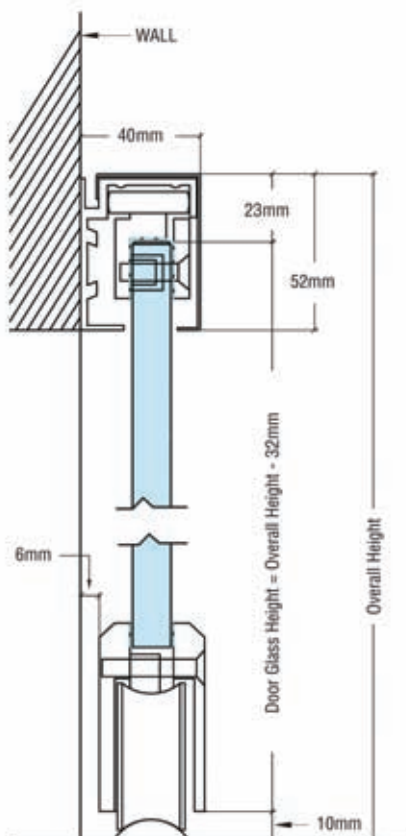

- Kits contain all necessary hardware to complete the installation
- One pair of rollers can accommodate doors weighing up to 130kg
- Brushed or polished stainless steel finishes
- Configurations for a single rolling door or bi-parting rolling doors

There are two configurations of GSDH Series Kits for glass doors. Both come with everything you need (except the toughened glass) to complete the installation, including top and bottom track, top guides, top guide roller stops, end covers, and the bottom rollers. Kits are available in a brushed or polished stainless steel finishes for both single and bi-parting rolling doors.

For more information on this versatile and easy-to-install system, contact CRL Technical Sales 00 800 0421 6144. You can also send e-mail from the home page of [crlaurence.co.uk](http://crlaurence.co.uk). Click on Contact Us, and then click on Technical Sales for Commercial Products.

**NOTE:** Laminated glass should not be used with the GSDH System.

### GLASS FABRICATION REQUIRED:

Four holes and two notches per panel. Glass templates included in kits.

| CAT. NO. | FINISH             | KIT DESCRIPTION          |
|----------|--------------------|--------------------------|
| GSDH1BS  | Brushed stainless  | Single rolling door      |
| GSDH1PS  | Polished stainless | Single rolling door      |
| GSDH2BS  | Brushed stainless  | Bi-parting rolling doors |
| GSDH2PS  | Polished stainless | Bi-parting rolling doors |

Minimum order: 1 each. Kits contain stock lengths of Top Track measuring 4m in length, and therefore must ship common carrier. Kits can be combined for quantity pricing.

## CRL GSDH1 Series Single Bottom Rolling Door Installation Assembly



- Available in brushed or polished stainless steel
- For use with 8, 10 or 12mm toughened glass
- 4m top guide track
- 3m bottom roller track

The CRL GSDH1 Series Single Bottom Rolling Door Installation Assembly contains all of the components you will need (except the toughened glass) to complete this style of installation.

This model can accommodate a single door weighing up to 130kg, with a maximum width of 1.5m.

## CRL GSDH2 Series Bi-Parting Bottom Rolling Door Installation Assembly



- Available in brushed or polished stainless steel
- For use with 8, 10 or 12mm toughened glass
- 4m top guide track
- 3m bottom roller track

The CRL GSDH2 Series Bi-Parting Bottom Rolling Door Installation Assembly contains all of the components you will need (except the toughened glass) to complete this style of installation.

This model can accommodate two bi-parting doors, each weighing up to 65kg, each with a maximum width of 762mm.



# CRL Laguna Series Sliding Glass Door System With Anti-Lift Safety Features



Typical Wall Mount Installation

- New anti-lift features for added safety
- All 316 alloy brushed stainless steel construction
- Ideal for interior applications
- For use with 10 or 12mm glass
- Comes with all fasteners needed for either flush (countersunk) or surface (straight hole) mounting
- Custom adaptor kits available for wood door applications



Soft close options available. Cat. No's. LSDSRH (right hand) & LSDSLH (left hand). Please call for details.



Typical Glass Mount Installation

We have upgraded our popular Laguna Series Sliding Glass Door System to now include a new 'anti-lift' feature. Through a combination of additions and very subtle changes, we have improved the performance, safety, and security while still offering a clean, simple look. The Laguna Series Sliding Glass Door System can be installed on glass partitions or directly to the side of a sufficiently reinforced wall. The adjustable Top Rollers make final adjustments quick and easy, without the need to remove the door. Their smooth operation and solid stainless steel construction minimizes maintenance issues.

CRL provides you with all the glass attachment fasteners for either flush mounting, requiring a countersunk hole, or surface mounting, requiring a straight hole. The glass attachment fasteners accommodate either 10 or 12mm toughened glass.

**NOTE:** Laminated glass cannot be used in these systems.

Standardized sets allow you to make planning and purchasing quick and easy for basic installations. We offer four different complete installation assemblies; two for wall mounting, and two for glass mounting. Available accessories give you the opportunity to customize the standard sets to accommodate the most imaginative designers. All components are sized to easily ship via UPS, which helps to keep your job costs and lead times down.

#### DOOR SYSTEM LIMITATIONS

|                      |       |
|----------------------|-------|
| Maximum door weight  | 100kg |
| Maximum panel width  | 1.36m |
| Maximum panel height | 2.50m |
| Maximum track length | 2.64m |

## CRL Cat. No. LSWM3BS Laguna Series Single Sliding Door Wall Mount Installation Assembly

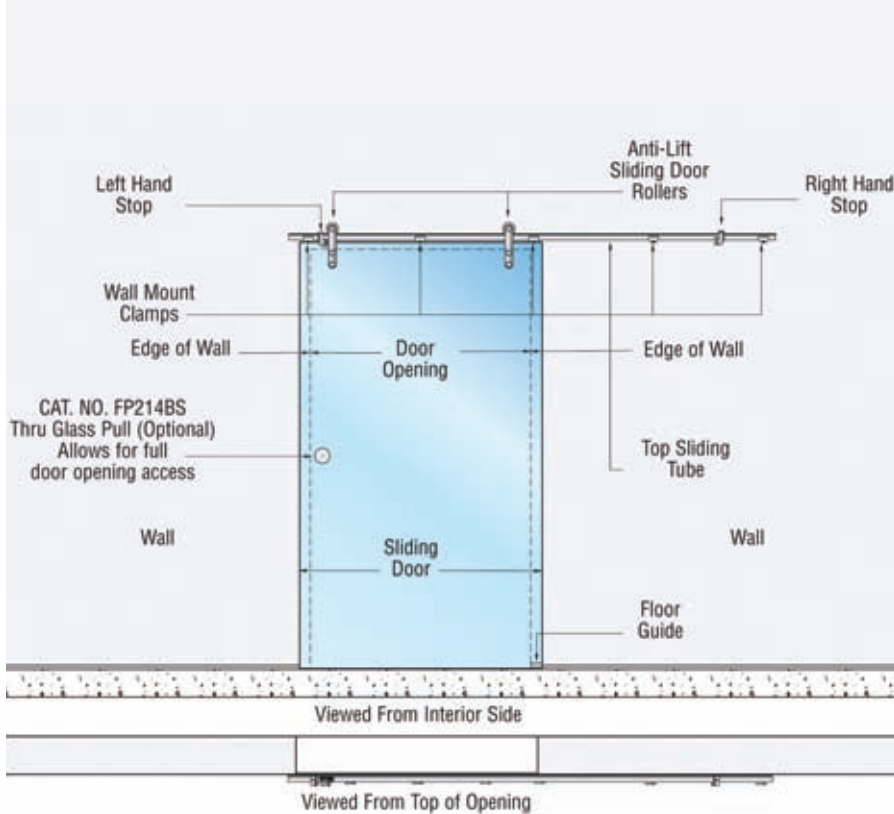

- New anti-lift design
- Assembly contains all necessary hardware to complete the installation with 10 or 12mm toughened glass
- Brushed stainless steel construction

The CRL Laguna Series Single Sliding Door Wall Mount Installation Assembly contains all of the components you will need (except the toughened glass) to complete this style of installation. This model is used in applications where you are attaching a single sliding door to the inside face of a sufficiently reinforced wall.

The Anti-Lift Sliding Door Top Rollers can be attached to the glass with either surface mount or flush mount fittings (both are supplied). The rollers have a 3.2mm +/- vertical adjustment to aid in door alignment. This system should only be used with 10 or 12mm toughened glass. Laminated glass cannot be used.

## CRL Cat. No. LSWM4BS Laguna Series Double Sliding Door Wall Mount Installation Assembly

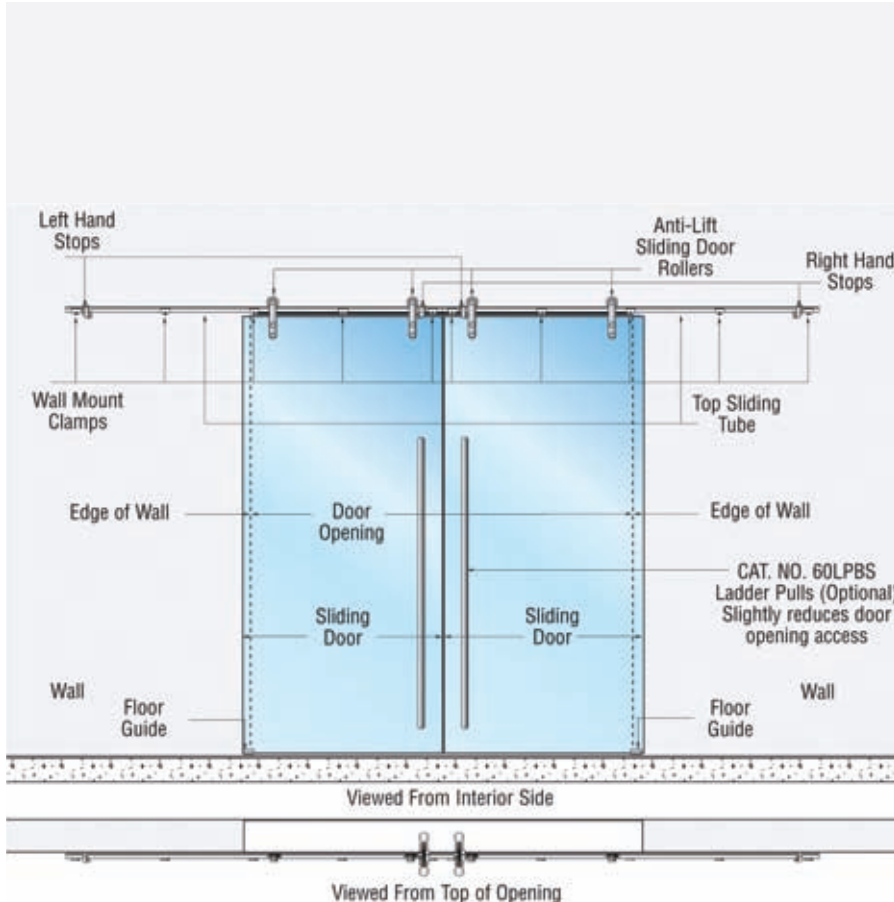

- New anti-lift design
- Assembly contains all necessary hardware to complete the installation with 10 or 12mm toughened glass
- Brushed stainless steel construction

The CRL Laguna Series Double Sliding Door Wall Mount Installation Assembly contains all of the components you will need (except the toughened glass) to complete this style of installation. This model is used in applications where you are attaching two bi-parting sliding doors to the inside face of a sufficiently reinforced wall.

The Anti-Lift Sliding Door Top Rollers can be attached to the glass with either surface mount or flush mount fittings (both are supplied). The rollers have a 3.2mm +/- vertical adjustment to aid in door alignment. This system should only be used with 10 or 12mm toughened glass. Laminated glass cannot be used.

### DOOR SYSTEM LIMITATIONS

|                      |       |
|----------------------|-------|
| Maximum door weight  | 100kg |
| Maximum panel width  | 1.36m |
| Maximum panel height | 2.50m |
| Maximum track length | 2.64m |

## CRL Cat. No. LSGM3BS Laguna Series Single Sliding Door Glass Mount Installation Assembly

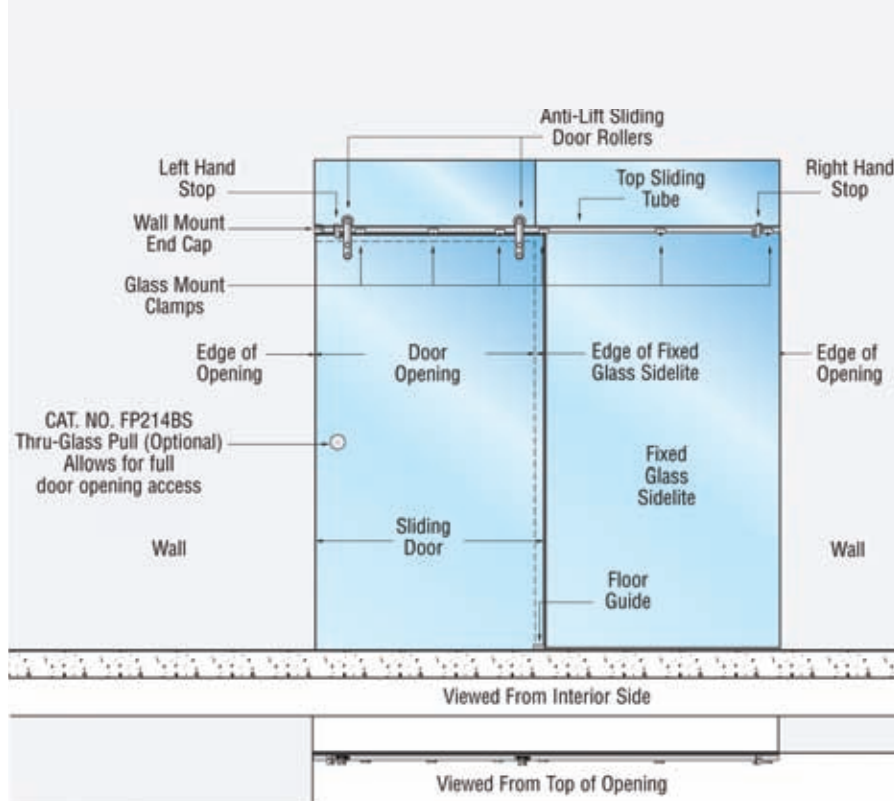

- New anti-lift design
- Assembly contains all necessary hardware to complete the installation with 10 or 12mm toughened glass
- Brushed stainless steel construction

The CRL Laguna Series Single Sliding Door Glass Mount Installation Assembly contains all of the components you will need (except the toughened glass) to complete this style of installation. This model is used in applications where you are attaching a single sliding door in an 'all-glass' opening where you have a wall on one end next to the door, a glass transom above the door, and a fixed glass panel on the other side of the door. Bi-parting double doors are not possible for this application.

The Anti-Lift Sliding Door Top Rollers can be attached to the glass with either surface mount or flush mount fittings (both are supplied). The rollers have a 3.2mm +/- vertical adjustment to aid in door alignment. This system should only be used with 10 or 12mm toughened glass. Laminated glass cannot be used.

## CRL Cat. No. LSGM4BS Laguna Series Single Sliding Door With Sidelites Glass Mount Installation Assembly

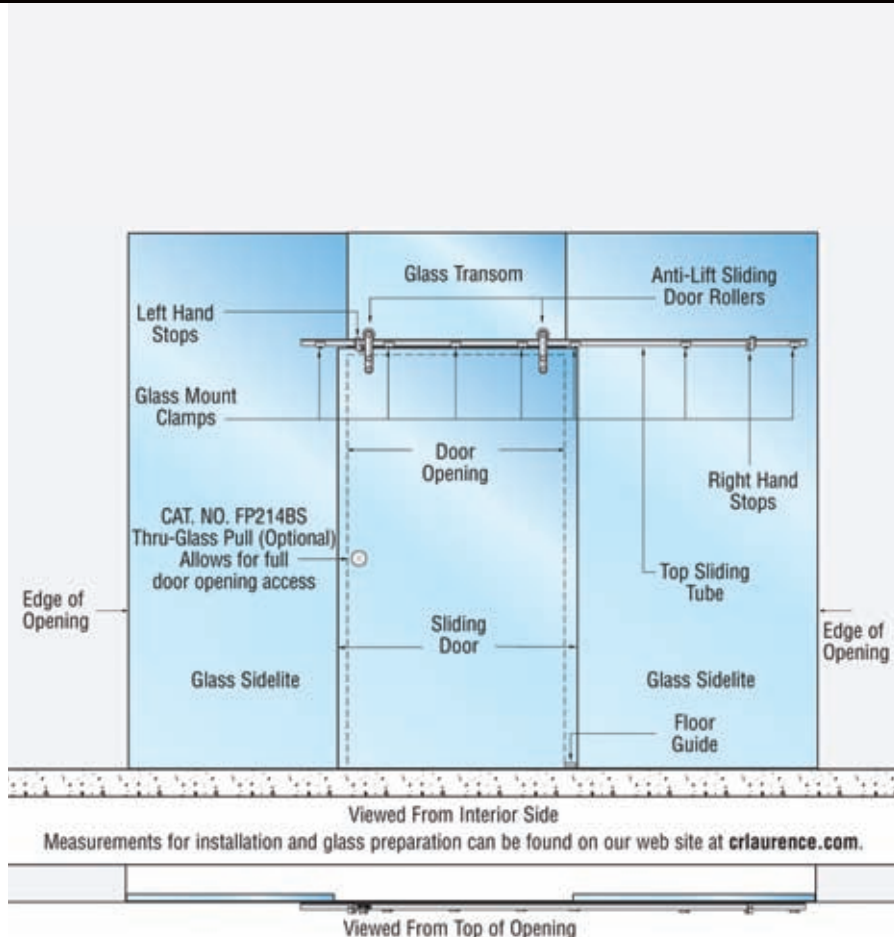

- New anti-lift design
- Assembly contains all necessary hardware to complete the installation with 10 or 12mm toughened glass
- Brushed stainless steel construction

The CRL Laguna Series Single Sliding Door With Sidelites Glass Mount Installation Assembly contains all of the components you will need (except the toughened glass) to complete this style of installation. This model is used in applications where you are attaching a single sliding door in an 'all-glass' opening where you have a glass transom above the door and fixed glass panels on both sides of the door. Bi-parting double doors are not possible for this application.

The Anti-Lift Sliding Door Top Rollers can be attached to the glass with either surface mount or flush mount fittings (both are supplied). The rollers have a 3.2mm +/- vertical adjustment to aid in door alignment. This system should only be used with 10 or 12mm toughened glass. Laminated glass cannot be used.

### DOOR SYSTEM LIMITATIONS

|                      |       |
|----------------------|-------|
| Maximum door weight  | 100kg |
| Maximum panel width  | 1.36m |
| Maximum panel height | 2.50m |
| Maximum track length | 2.64m |



# CRL Stacking Partition System (SPS)

## CRL SPS Overhead Straight Track



Standard track for almost any installation



Flanged track for drop ceiling installations

Various SPS Corners and Intersections available, please contact us.

## CRL SPS Overhead Curved Track



- Two track styles: Standard –for almost any installation; and flanged – for drop ceiling installations
- Available in mill aluminium or white powder paint finishes (cladding on special order)
- Two stock lengths 3.05m and 6.10m, plus splices for roller access
- Track is pre-drilled for 9.5mm fasteners at 610mm center-to-center spacing
- Fabricated corners and intersections

CRL SPS Overhead Track and Access Splices are 6063-T6 Alloy Aluminium, and are designed to accommodate the heavier loads required in stacking system installations. Two configurations, three lengths, and two finishes are carried in stock for immediate shipment. Lengths requiring cladding require 5 to 7 working days to fabricate plus shipping time. All lengths are pre-drilled at 610mm on centre for 9.5mm fasteners.

| STANDING TRACK CAT. NO. | FLANGED TRACK CAT. NO. | DESCRIPTION                      | FINISH             | LENGTH  |
|-------------------------|------------------------|----------------------------------|--------------------|---------|
| S90120M                 | L90120M                | Pre-drilled overhead track       | Mill aluminium     | 3.05m   |
| S90240M                 | L90240M                | Pre-drilled overhead track       | Mill aluminium     | 6.10m   |
| S906M                   | L906M                  | Pre-drilled roller access splice | Mill aluminium     | 152.4mm |
| S90120W                 | L90120W                | Pre-drilled overhead track       | White powder paint | 3.05m   |
| S90240W                 | L90240W                | Pre-drilled overhead track       | White powder paint | 6.10m   |
| S906W                   | L906W                  | Pre-drilled roller access splice | White powder paint | 152.4mm |

Minimum order: 1 each. Must ship common carrier. \*Roller Access Splice should be located in front of the first parking intersection.

- Curved track configuration in standard style only
- Available in mill aluminium or white powder paint finishes (cladding on special order)
- Length and radius\* must be specified at time of ordering

CRL SPS Curved Overhead Track is 6063-T6 Alloy Aluminium, and is designed to accommodate the heavier loads required in stacking system installations. Curved overhead track is offered only in the standard style. Length and radius\* must be specified at time of ordering. Minimum radius is 3.66m. Special manufacturing and shipping terms apply.

| CURVED TRACK CAT. NO. | FINISH             | LENGTH AND RADIUS |
|-----------------------|--------------------|-------------------|
| C90MC                 | Mill aluminium     | Custom - specify  |
| C90WC                 | White powder paint | Custom - specify  |

Minimum order: 1 each. Must ship common carrier.



# CRL EZ-Slide Top Hung Single Track Sliding Door Kits



- No notches or holes needed in the glass for installation

The CRL EZ-Slide Top Hung Single Track Sliding Door Kits are an easy to install cost effective solution to adding 'all-glass' sliding doors in commercial or residential applications.

The only glass fabrication required is to polish the edges. If handles or knobs are desired, holes will be required for their mounting. Optional break metal covers are available on special order to help conceal the operating hardware.

**NOTE:** The EZ-Slide System is not designed for use in shower or steam room applications and should not be used with laminated glass. Everything (except the toughened glass) to complete a single panel slider application is available in our easy to order Kit, and comes with all the items shown below. Pull hardware is sold separately. For more information on this versatile and easy to install system, contact CRL Technical Sales.

## Each Kit Contains

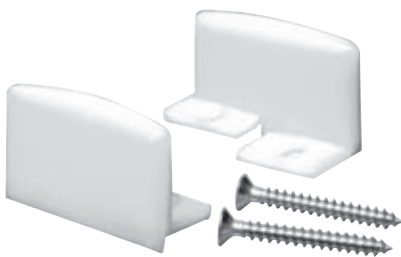

1 x Bottom Guide



1 x Top Track at 4m in length



2 x Regulator Bolts

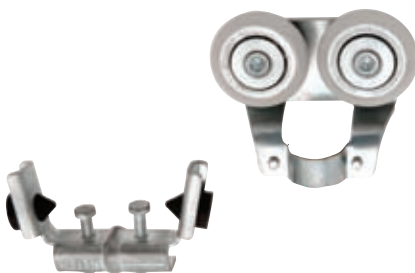

2 x Top Rollers and Stops



2 x Clamp Assemblies

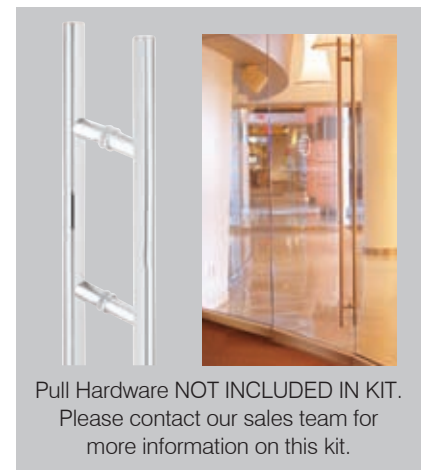

Pull Hardware NOT INCLUDED IN KIT.  
Please contact our sales team for more information on this kit.

## CRL EZ-Slide 80

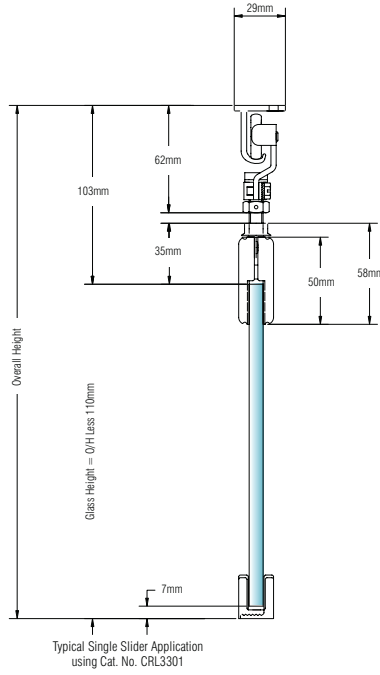
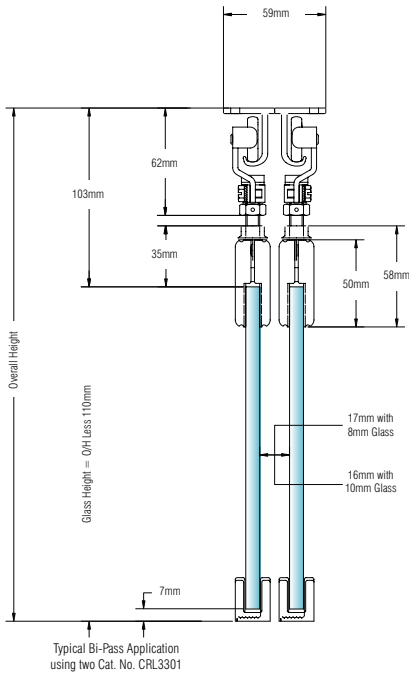

### CRL EZ-SLIDE 80 TOP HUNG SINGLE TRACK SLIDING DOOR KIT

| CAT. NO. | KIT DESCRIPTION                      |
|----------|--------------------------------------|
| CRL3301  | Kit for 8-10mm thick toughened glass |

- This kit is for 8mm or 10mm toughened glass
- Rated for panels weighing up to 80kg

Minimum order: 1 each. Kits contain stock lengths of Top Track measuring 3m in length, and therefore must ship common carrier. Kits can be combined for quantity pricing.

## CRL EZ-Slide 180

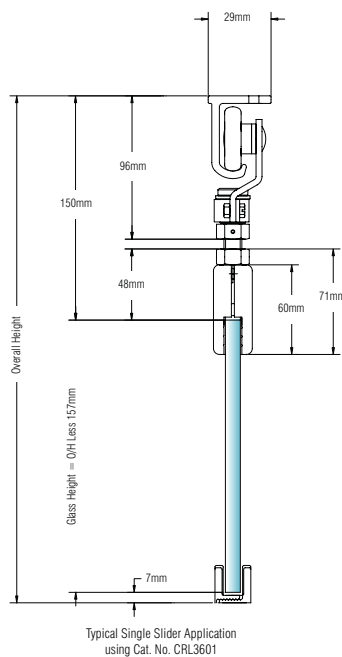
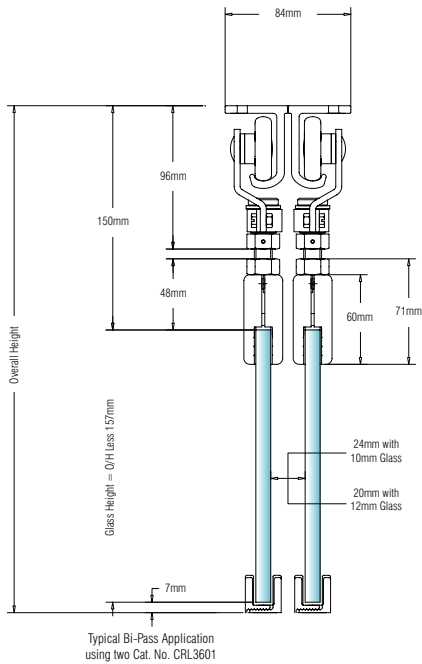

### CRL EZ-SLIDE 180 TOP HUNG SINGLE TRACK SLIDING DOOR KIT

| CAT. NO. | KIT DESCRIPTION                       |
|----------|---------------------------------------|
| CRL3601  | Kit for 10-12mm thick toughened glass |

- This kit is for 10mm or 12mm toughened glass
- Rated for panels weighing up to 180kg

Minimum order: 1 each. Kits contain stock lengths of Top Track measuring 3m in length, and therefore must ship common carrier. Kits can be combined for quantity pricing.

Call FREE on 00 800 0421 6144

Fax FREE on 00 800 0262 3299



**Manchester**

Charles Babbage Avenue  
Kingsway Business Park,  
Rochdale, OL16 4NW, England  
Tel: +44 (0) 1706 863 600  
Fax: +44 (0) 1706 869 860  
[www.crlaurence.co.uk](http://www.crlaurence.co.uk)



**Stuttgart**

Boschstrasse 7  
D-74360 Ilsfeld  
Germany  
Tel: +49 (0) 7062 915 93 15  
Fax: +49 (0) 7062 915 93 16  
[www.crlaurence.de](http://www.crlaurence.de)



**Copenhagen**

Stamholmen 70 Unit B,  
DK-2650 Hvidovre  
Denmark  
Tel: +45 36 72 09 00  
Fax: +45 36 70 33 35  
[www.crlaurence.dk](http://www.crlaurence.dk)



**France**

Boschstrasse 7  
D-74360 Ilsfeld  
Germany  
Tel: +49 (0) 7062 915 93 15  
Fax: +49 (0) 7062 915 93 16  
[www.crlaurence.fr](http://www.crlaurence.fr)

