

Architectural Hardware

08 71 00 Door Hardware
08 74 00 Access Control
Lock Systems

CAT. NO.
LP11

COMMERCIAL DOOR HANDLES

- Ladder Pull Handles
- Locking Ladder Pull Handles
- One and Two Point Center Locks
- Deadbolt Handles
- Panic Handles
- Electronic Egress Handles
- Center Locks
- Push Pull Handles
- Aluminum Door Handles
- Custom Door Handles



CRL[®]

ISO 9001:2008 Certified
C.R. LAURENCE COMPANY
crlaurence.com | Worldwide Supplier

CRL Straight Style Ladder Pulls

- Eleven Sizes in Two Popular Finishes for 3/8" to 3/4" (10 to 19 mm) Glass or 1-3/4" (44 mm) Aluminum Doors
- Extra Height for Eye-Catching Contemporary and Elegant Appearance
- 1-1/4" (32 mm) Diameter Heavy Wall 304 Alloy Stainless Steel Tubing
- Custom Finishes and Sizes Available



Straight Style

CRL Ladder Style Pull Handles add elegance and eye-catching appeal to commercial glass doors. They are designed for back-to-back mounting with supplied through-bolts.

Ladder Style Pulls are intended for use with full size glass doors made from 3/8" to 3/4" (10 to 19 mm) thick tempered glass. Fasteners are included for mounting back-to-back on 1-3/4" (44 mm) thick aluminum doors as well. Stock sizes range from 24" to 84" (610 to 2134 mm) overall height. Standard finishes are polished stainless and brushed stainless.

Custom sizes and finishes are available to meet architectural specifications. For additional information or to begin the custom design process, contact CRL Technical Sales at (800) 421-6144 in the U.S., (877) 421-6144 from Canada, or (323) 588-1281 International, and ask for Ext. 7700. You can also e-mail us through our web site at crlaurence.com. From the home page click on Contact Us, and then click on Technical Sales for Commercial Products.

SPECIFICATIONS:

For Use With:

3/8" to 3/4" (10 to 19 mm) Glass, or 1-3/4" (44 mm) Aluminum Doors

Construction:

1-1/4" (32 mm) Diameter Stainless Steel Tubing

Glass Fabrication Required:

Two 5/8" (16 mm) Diameter Holes

STRAIGHT STYLE LADDER PULL HANDLES

CAT. NO.	OVERALL LENGTH	MOUNTING HOLES CENTER-TO-CENTER	FINISH
24LPPS	24" (610 mm)	12" (305 mm)	Polished Stainless
24LPBS	24" (610 mm)	12" (305 mm)	Brushed Stainless
30LPPS	30" (762 mm)	18" (457 mm)	Polished Stainless
30LPBS	30" (762 mm)	18" (457 mm)	Brushed Stainless
36LPPS	36" (914 mm)	24" (610 mm)	Polished Stainless
36LPBS	36" (914 mm)	24" (610 mm)	Brushed Stainless
42LPPS	42" (1067 mm)	30" (762 mm)	Polished Stainless
42LPBS	42" (1067 mm)	30" (762 mm)	Brushed Stainless
48LPPS	48" (1219 mm)	36" (914 mm)	Polished Stainless
48LPBS	48" (1219 mm)	36" (914 mm)	Brushed Stainless
54LPPS	54" (1372 mm)	42" (1067 mm)	Polished Stainless
54LPBS	54" (1372 mm)	42" (1067 mm)	Brushed Stainless
60LPPS	60" (1524 mm)	48" (1219 mm)	Polished Stainless
60LPBS	60" (1524 mm)	48" (1219 mm)	Brushed Stainless
66LPPS	66" (1676 mm)	54" (1372 mm)	Polished Stainless
66LPBS	66" (1676 mm)	54" (1372 mm)	Brushed Stainless
72LPPS	72" (1829 mm)	60" (1524 mm)	Polished Stainless
72LPBS	72" (1829 mm)	60" (1524 mm)	Brushed Stainless
78LPPS	78" (1981 mm)	66" (1676 mm)	Polished Stainless
78LPBS	78" (1981 mm)	66" (1676 mm)	Brushed Stainless
84LPPS	84" (2134 mm)	72" (1829 mm)	Polished Stainless
84LPBS	84" (2134 mm)	72" (1829 mm)	Brushed Stainless

Minimum order: 1 each. Sizes and finishes can be combined for quantity pricing. Additional holes required if extra Mid-Posts added (see top right).

Optional Extra Mid-Posts give added strength to very long Ladder Pulls. Must be factory-installed. Call for details.



Offset Mid-Posts

Optional Offset Mid-Posts are available to convert Straight Style Ladder Pulls to Offset Mount. Two pair per set. Minimum order is one set.

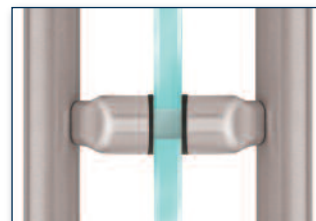

CAT. NO. LPOPS

Polished Stainless Offset Mid-Posts



Top View

CAT. NO. LPOBS

Brushed Stainless Offset Mid-Posts

CRL "S" Style Ladder Pulls

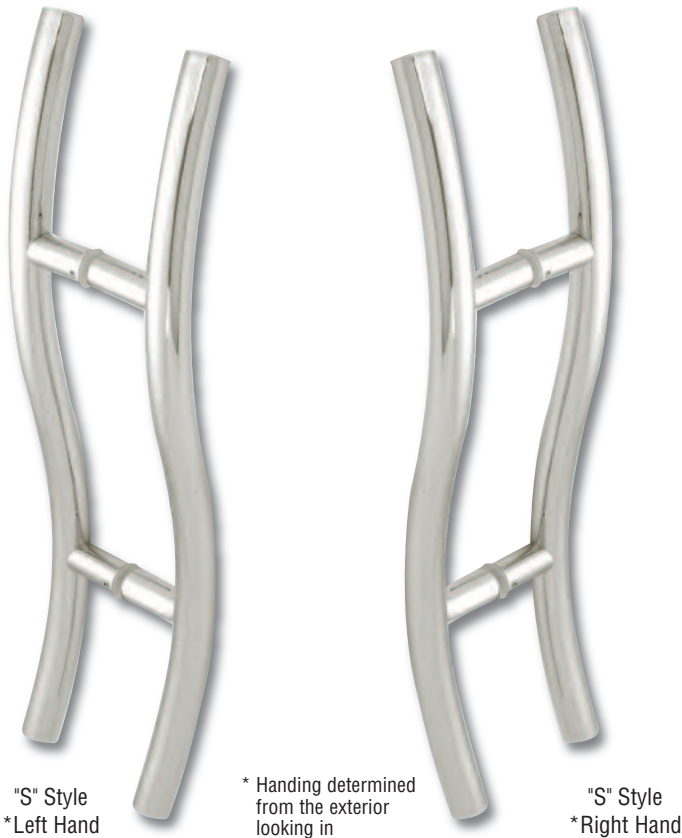

- Three Sizes in Two Popular Finishes for 3/8" to 3/4" (10 to 19 mm) Glass
- Designer Left and Right Hand Models Available
- 1-1/4" (32 mm) Diameter Heavy Wall 304 Alloy Stainless Steel Tubing
- Custom Finishes and Sizes Available

CRL "S" Style Ladder Style Pull Handles are for back-to-back mounting with supplied through-bolts.

"S" Style Ladder Style Pulls are intended for use with full size glass doors made from 3/8" to 3/4" (10 to 19 mm) thick tempered glass. Stock sizes range from 24" to 48" (610 to 1219 mm) overall height. Standard finishes are polished stainless and brushed stainless. The Pulls are handed left and right to ensure the exposed set-screws are always on the interior side of the door. Handing is determined from the exterior side looking in.

Custom sizes and finishes are available to meet architectural specifications. For additional information or to begin the custom design process, contact CRL Technical Sales at (800) 421-6144 in the U.S., (877) 421-6144 from Canada, or (323) 588-1281 International, and ask for Ext. 7700. You can also e-mail us through our web site at crlaurence.com. From the home page click on Contact Us, and then click on Technical Sales for Commercial Products.

SPECIFICATIONS:

For Use With:

3/8" to 3/4" (10 to 19 mm) Glass

Construction:

1-1/4" (32 mm) Diameter Stainless Steel Tubing

Glass Fabrication Required:

Two 5/8" (16 mm) Diameter Holes



"S" STYLE LADDER PULL HANDLES

CAT. NO.	HANDING *	OVERALL LENGTH	MOUNTING HOLES CENTER-TO-CENTER	FINISH
24SLPPS	Left Hand	24" (610 mm)	12" (305 mm)	Polished Stainless
24SLPBS	Left Hand	24" (610 mm)	12" (305 mm)	Brushed Stainless
24SRPPS	Right Hand	24" (610 mm)	12" (305 mm)	Polished Stainless
24SRPBS	Right Hand	24" (610 mm)	12" (305 mm)	Brushed Stainless
36SLPPS	Left Hand	36" (914 mm)	24" (610 mm)	Polished Stainless
36SLPBS	Left Hand	36" (914 mm)	24" (610 mm)	Brushed Stainless
36SRPPS	Right Hand	36" (914 mm)	24" (610 mm)	Polished Stainless
36SRPBS	Right Hand	36" (914 mm)	24" (610 mm)	Brushed Stainless
48SLPPS	Left Hand	48" (1219 mm)	36" (914 mm)	Polished Stainless
48SLPBS	Left Hand	48" (1219 mm)	36" (914 mm)	Brushed Stainless
48SRPPS	Right Hand	48" (1219 mm)	36" (914 mm)	Polished Stainless
48SRPBS	Right Hand	48" (1219 mm)	36" (914 mm)	Brushed Stainless

Minimum order: 1 each. Sizes and finishes can be combined for quantity pricing. "S" Style Handles exceeding 48" (1219 mm) overall length must be discussed with CRL Technical Sales to determine proper application.

CRL Locking Ladder Pulls

- Locks Operate at a Comfortable Height Above the Floor
- No Kneeling or Bending to Lock or Unlock Doors
- Seven Styles in Stock, Custom Sizes Available on Special Order
- Made of Durable Alloy 316 Stainless Steel Tubing
- Single and Double Locking Options Available
- 1-1/4" (32 mm) Long Deadbolt - All Units

new



Vertical Double Locking Ladder Pulls

The newest and most practical option for 'all-glass' entrances is CRL's new Locking Ladder Pulls. No more kneeling down to unlock the entry doors in the morning, or having to bend over after a long day at work to reach for the lock at the bottom edge of the door. Simply turn a key or thumbturn located at a comfortable height above the finished floor to lock or unlock your doors. CRL Locking Ladder Pulls have a fully concealed deadbolt locking mechanism with models available that lock into the floor, both floor and head locking, and Horizontal Pulls that lock into a jamb or sidelite. These Locking Ladder Pulls are intended for use with glass doors made from 3/8" to 1/2" (10 to 12 mm) thick tempered glass.

For additional information contact CRL Technical Sales (800) 421-6144 in the U.S., (877) 421-6144 from Canada, or (323) 588-1281 International, and ask for Ext. 7700. You can also send e-mail from the crlaurence.com home page. Click on Contact Us, and then click on Technical Sales for Commercial Products.



Horizontal Locking Ladder Pulls

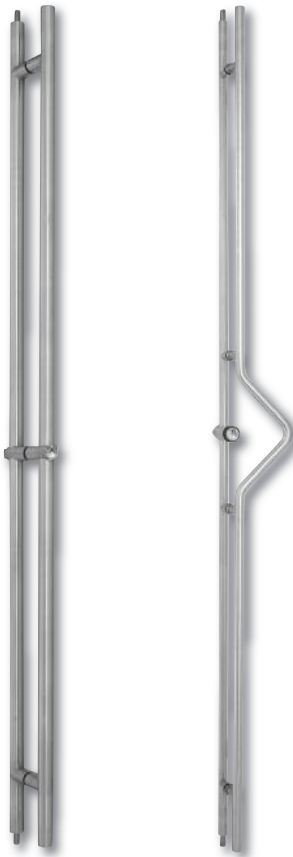

Vertical Double Locking Ladder Pulls

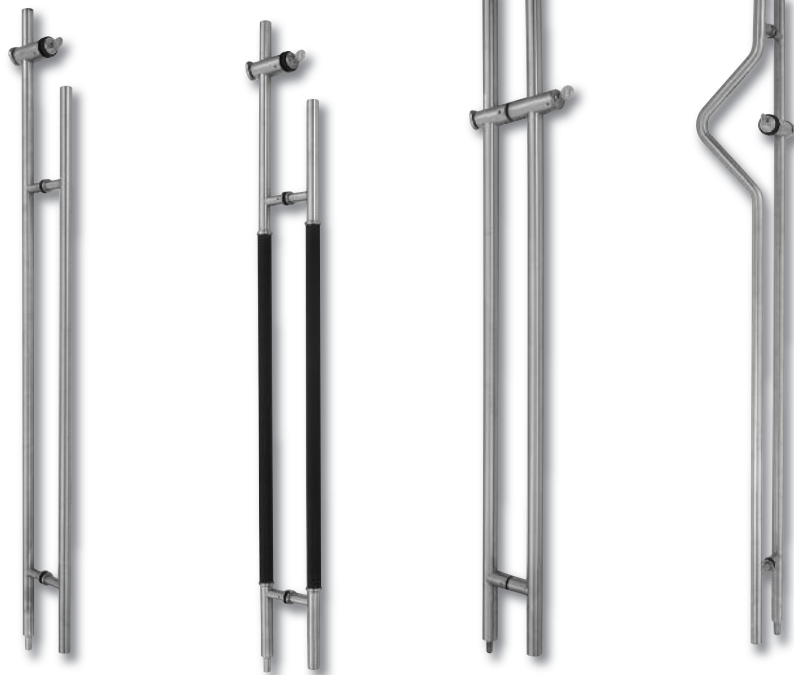

Vertical Floor Locking Ladder Pulls

CRL 53" Locking Ladder Pulls

- Lock Operates at a Comfortable 47-1/4" (1200 mm) Above the Floor
- Available in Brushed Stainless or With Black Leather Wrapped Handle*
- Locks Into the Floor Only
- 1" (25 mm) Diameter Alloy 316 Stainless Steel Tubing

new



Interior Installation With Black Leather Wrapped Locking Ladder Pull Handles

Our new 53" (1346 mm) Locking Ladder Pulls have a fully concealed deadbolt locking mechanism that is operated at 47-1/4" (1200 mm) above the floor. No need to bend, simply turn a key or thumbturn located at a comfortable height above the finished floor to lock or unlock your doors. These Locking Ladder Pulls are intended for use with glass doors made from 3/8" to 1/2" (10 to 12 mm) thick tempered glass. They lock into the floor only, and are available in brushed stainless steel, or for a truly unique look, black leather wrapped handle over brushed stainless steel. One Cat. No. 58DKBS Dustproof Keeper is included with each Locking Ladder Pull. 7-Pin Small Format Interchangeable Cores (SFIC) are sold separately (see page L217). **NOTE:** Glass fabrication is required. Please visit crlaurence.com for details. For Push/Pull Indicators in complementary finishes please visit crlaurence.com.



* Leather Wrapped Handles are for Interior Applications Only

← Floor Locking Only →

***CAT. NO. LLP053LBS**

Brushed Stainless Steel Locking Ladder Pull Handle with Black Leather Wrap

CAT. NO. LLP053BS

Brushed Stainless Steel Locking Ladder Pull Handle

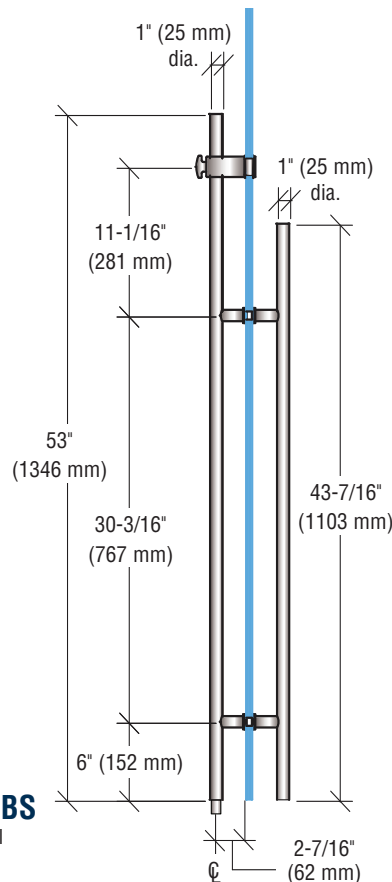

Easy to Operate Designer Thumbturn



7-Pin Small Format Interchangeable Cores (SFIC) for easy re-keying of handles. See page L217 for additional information on Cylinder Cores sold separately.

CRL 59" Locking Ladder Pull

- Lock Operates at a Comfortable 47-1/4" (1200 mm) Above the Floor
- Locks Into the Floor Only
- 1-3/8" (35 mm) Diameter Alloy 316 Brushed Stainless Steel Tubing

new



Our new Locking Ladder Pulls have a fully concealed deadbolt locking mechanism that is operated at 47-1/4" (1200 mm) above the floor. No need to bend, simply turn a key or thumbturn located at a comfortable height above the finished floor to lock or unlock your doors. These Locking Ladder Pulls are intended for use with glass doors made from 3/8" to 1/2" (10 to 12 mm) thick tempered glass. They lock into the floor only, and are available in brushed stainless steel. One Cat. No. 58DKBS Dustproof Keeper is included with each Locking Ladder Pull. 7-Pin Small Format Interchangeable Cores (SFIC) are sold separately (see page L217). **NOTE:** Glass fabrication is required. Please visit crlaurence.com for details. For Push/Pull Indicators in complementary finishes please visit crlaurence.com.

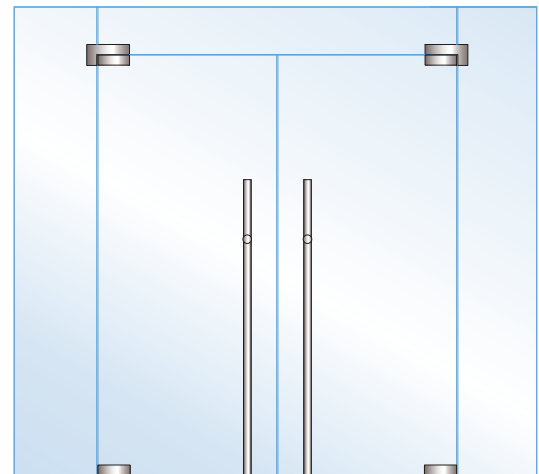
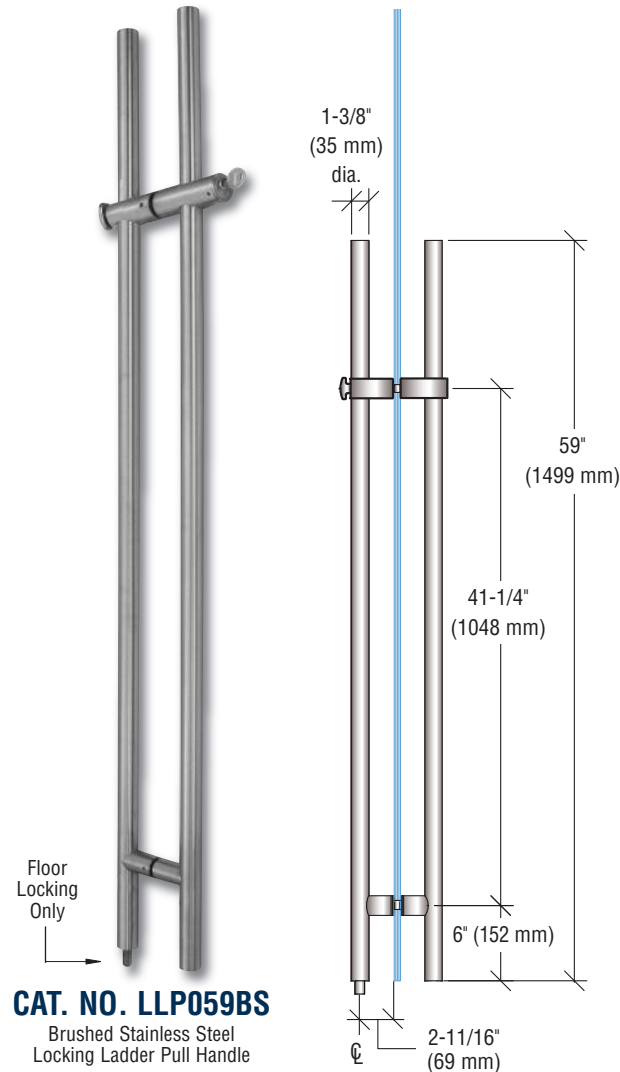

Double Door Installations Require Two Locking Handles

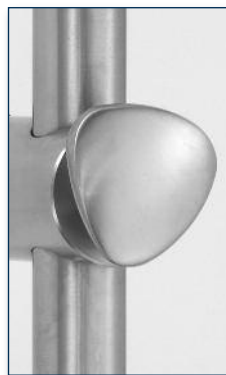

Easy to Operate Designer Thumbturn



7-Pin Small Format Interchangeable Cores (SFIC) for easy re-keying of handles. See page L217 for additional information on Cylinder Cores sold separately.

CRL 84" Double Locking Ladder Pull

- Top and Bottom Double Locking Ladder Pull Handle
- Lock Operates at a Comfortable 47-1/4" (1200 mm) Above the Floor
- 1-3/8" (35 mm) Diameter Alloy 316 Brushed Stainless Steel Tubing

Our new Double Locking Ladder Pulls have a fully concealed deadbolt locking mechanism that is operated at 47-1/4" (1200 mm) above the floor. No need to bend, simply turn a key or thumbturn located at a comfortable height above the finished floor to lock or unlock your doors. These Locking Ladder Pulls are intended for use with glass doors made from 3/8" to 1/2" (10 to 12 mm) thick tempered glass. They lock both at the header or transom and floor for ultimate security. Two Cat. No. 58DKBS Dustproof Keepers are included with each Locking Ladder Pull. Optional Ladder Keepers for glass transoms are available separately (see top right). 7-Pin Small Format Interchangeable Cores (SFIC) are sold separately (see page L217). **NOTE:** Glass fabrication is required. Please visit crlaurence.com for details. For Push/Pull Indicators in complementary finishes, please visit crlaurence.com.



Double Door Installations Require Two Locking Handles



new



CAT. NO. LPK1BS

1-3/8" (35 mm) Diameter
Brushed Stainless
Ladder Keeper
(see page L209 for more options)

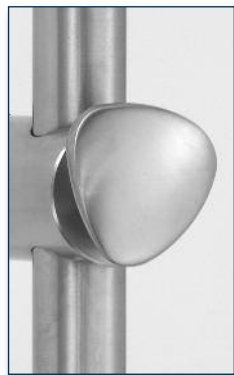
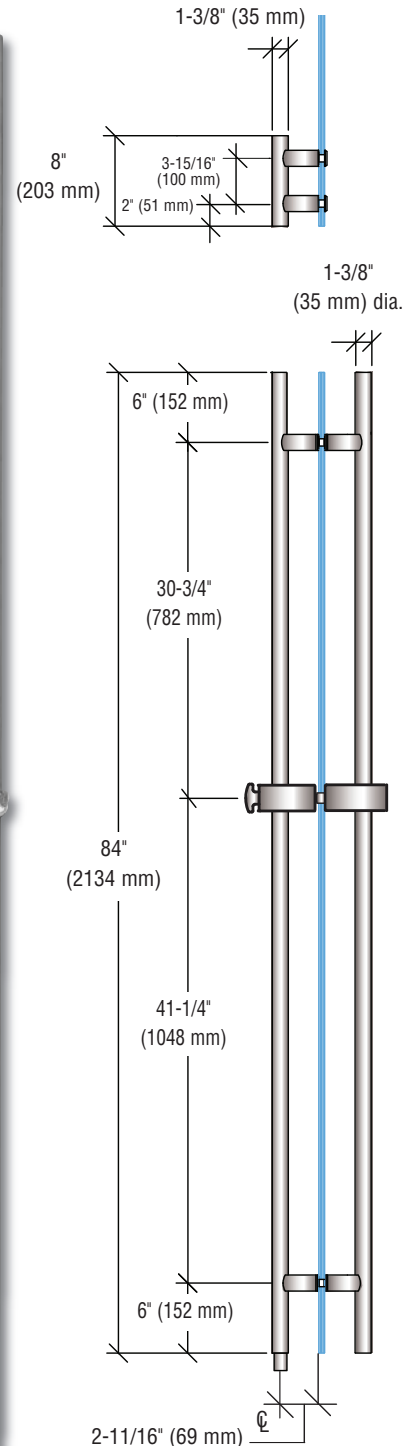

Easy to Operate Designer Thumbturn



7-Pin Small Format Interchangeable Cores (SFIC) for easy re-keying of handles. See page L217 for additional information on Cylinder Cores sold separately.

Double Locking Top and Bottom

CAT. NO. LLP084BS

Brushed Stainless Steel Double Locking Ladder Pull Handle

CRL 55" Triangular Locking Ladder Pulls

- Locks Into the Floor Only
- Left and Right Hand Models for Single and Double Doors
- 1" (25 mm) Diameter Alloy 316 Brushed Stainless Steel Tubing

new



Our new Triangular Locking Ladder Pulls have a fully concealed deadbolt locking mechanism that is operated at 43-5/16" (1100 mm) above the floor. No need to bend, simply turn a key or thumbturn located at a comfortable height above the finished floor to lock or unlock your doors. These Locking Ladder Pulls are intended for use with glass doors made from 3/8" to 1/2" (10 to 12 mm) thick tempered glass. They lock into the floor only, and are available in brushed stainless steel. One Cat. No. 58DKBS Dustproof Keeper is included with each Locking Ladder Pull. 7-Pin Small Format Interchangeable Cores (SFIC) are sold separately (see page L217). **NOTE:** Glass fabrication is required. Please visit crlaurence.com for details. For Push/Pull Indicators in complementary finishes please visit crlaurence.com.



Single Door Installation With Right Hand Locking Handle

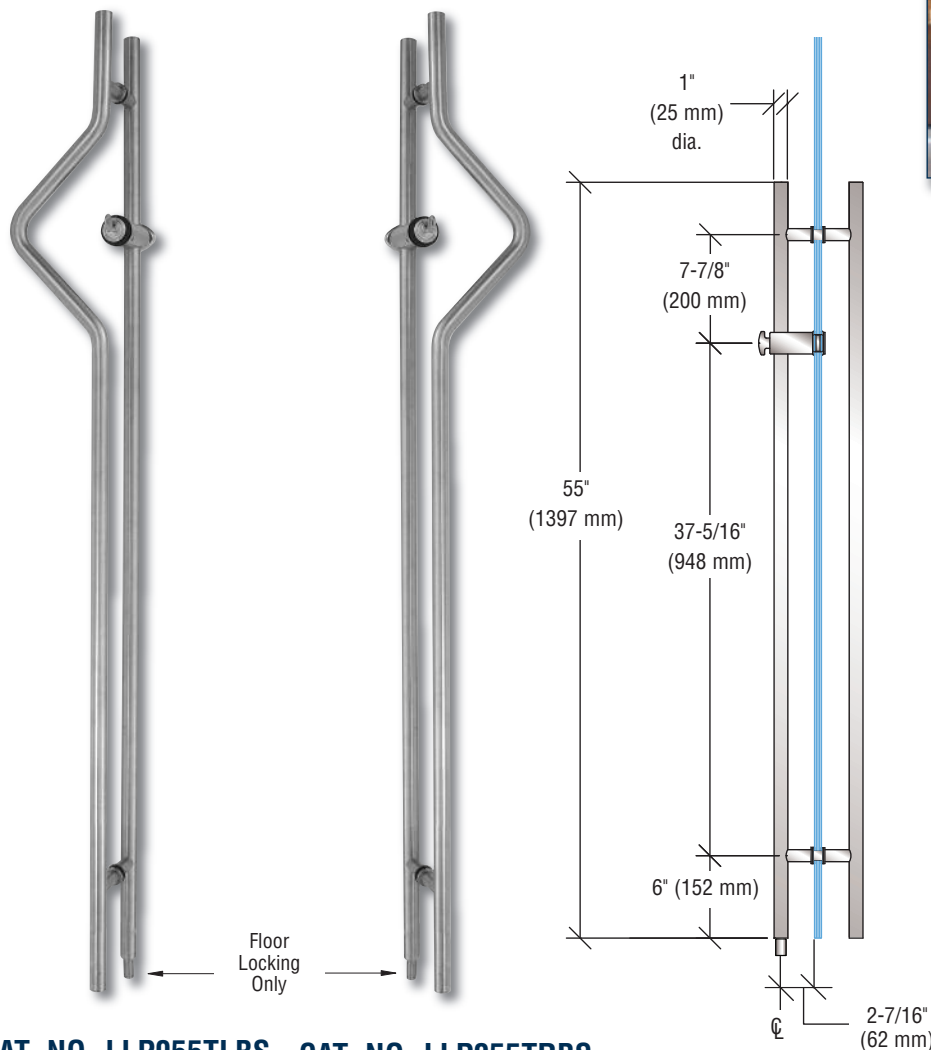

CAT. NO. LLP055TLBS

* Left Hand Triangular Locking Ladder Pull Handle

CAT. NO. LLP055TRBS

* Right Hand Triangular Locking Ladder Pull Handle

* Handing is determined from the exterior looking in



Easy to Operate Designer Thumbturn



7-Pin Small Format Interchangeable Cores (SFIC) for easy re-keying of handles. See page L217 for additional information on Cylinder Cores sold separately.

CRL 84" Triangular Double Locking Ladder Pulls

- Locks at Both Top and Bottom
- Left and Right Hand Models for Single and Double Doors
- 1" (25 mm) Diameter Alloy 316 Brushed Stainless Steel Tubing

Our new Triangular Locking Ladder Pulls have a fully concealed deadbolt locking mechanism that is operated at 43-5/16" (1100 mm) above the floor. No need to bend, simply turn a key or thumbturn located at a comfortable height above the finished floor to lock or unlock your doors. These Locking Ladder Pulls are intended for use with glass doors made from 3/8" to 1/2" (10 to 12 mm) thick tempered glass. They lock both at the header or transom and floor for ultimate security. Available in brushed stainless steel. Two Cat. No. 58DKBS Dustproof Keepers are included with each Locking Ladder Pull. Keepers for glass transoms are available separately (see top right). 7-Pin Small Format Interchangeable Cores (SFIC) are sold separately (see page L217). **NOTE:** Glass fabrication is required. Please visit crlaurence.com for details. For Push/Pull Indicators in complementary finishes please visit crlaurence.com.

new

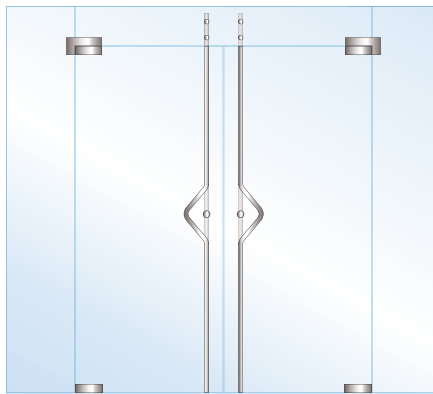

Double Door Installations Require One Left and One Right Hand Locking Handle

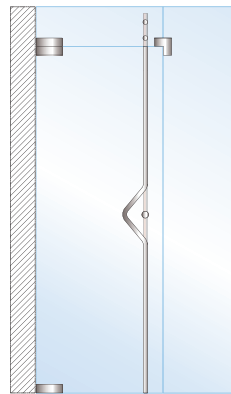

Single Door Installations Require One Left or Right Handed Locking Handle



Easy to Operate Designer Thumbturn



7-Pin Small Format Interchangeable Cores (SFIC) for easy re-keying of handles. See page L217 for additional information on Cylinder Cores sold separately.

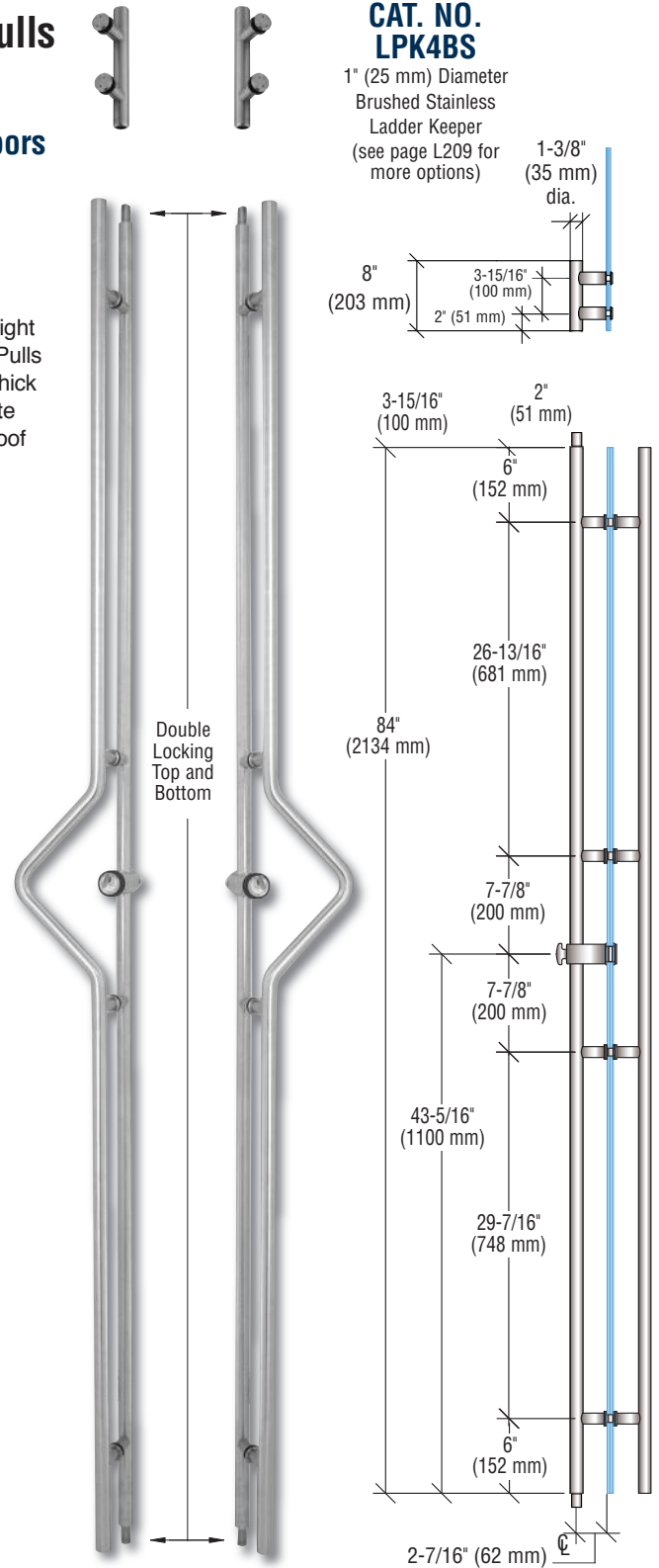

CAT. NO. LPK4BS

1" (25 mm) Diameter Brushed Stainless Ladder Keeper (see page L209 for more options)

1-3/8" (35 mm) dia.

CAT. NO. LLP084TLBS

* Left Hand Brushed Stainless Triangular Double Locking Ladder Pull Handle

CAT. NO. LLP084TRBS

* Right Hand Brushed Stainless Triangular Double Locking Ladder Pull Handle

* Handing is determined from the exterior looking in

CRL 24" Horizontal Locking Ladder Pull and Keeper

- Horizontal Locking Ladder Pull Handle for Contemporary Look
- For Double and Single Doors
- 1" (25 mm) Diameter Alloy 316 Brushed Stainless Steel Tubing

new



Our new Horizontal Locking Ladder Pull will give your 3/8" to 1/2" (10 to 12 mm) tempered glass doors a contemporary look. They have a fully concealed deadbolt locking mechanism that locks into a complementary Horizontal Keeper for double door or single door with fixed glass panel installations. On single door installations the concealed locking mechanism engages into a Dustproof Keeper on the wall. No need to bend, simply turn key or thumbturn located at a comfortable height above the finished floor to lock or unlock your doors. These Horizontal Locking Ladder Pulls are available in brushed stainless steel. One Cat. No. 58DKBS Dustproof Keeper is included with each Locking Ladder Pull. Matching Horizontal Keeper Ladder Pull Handles are sold separately (see below). 7-Pin Small Format Interchangeable Cores (SFIC) are sold separately (see page L217). **NOTE:** Glass fabrication is required. Please visit crlaurence.com for details. Placement of pulls in relation to vertical edge of door is critical and dependent upon application, handing of doors and jamb conditions. For Push/Pull Indicators in complementary finishes please visit crlaurence.com.



CAT. NO. LLP024BS

Brushed Stainless Steel Horizontal Locking Ladder Pull Handle



CAT. NO. LPK3BS

Brushed Stainless Steel Horizontal Keeper Ladder Pull Handle

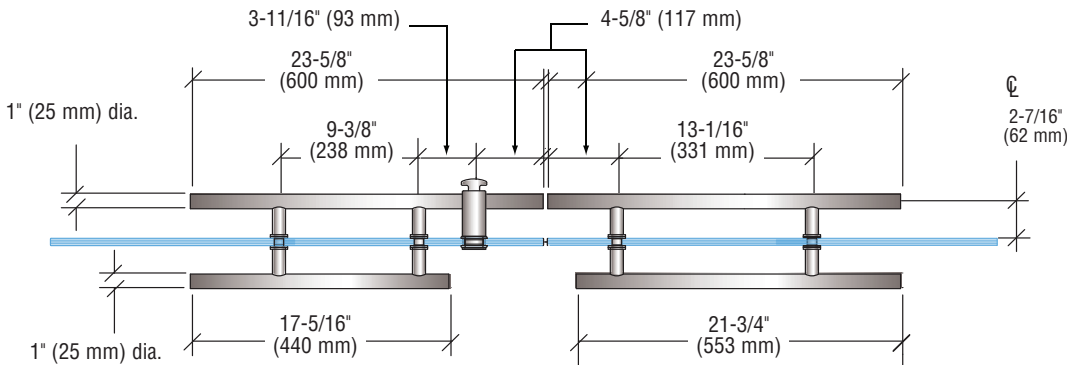

Easy to Operate Designer Thumbturn

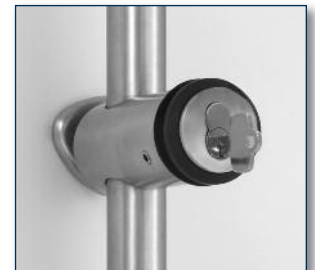

7-Pin Small Format Interchangeable Cores (SFIC) for easy re-keying of handles. See page L217 for additional information on Cylinder Cores sold separately.

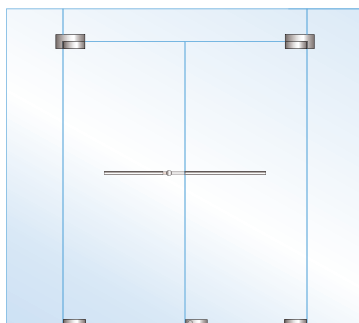

Double Door Installations Require One Locking Handle and One Keeper Handle, as well as a Bottom Patch Lock Installed on the Inactive Leaf to Properly Secure the Pair of Doors



Single Door Installations Require One Locking Handle and a Dustproof Keeper

CRL 1-3/8" (35 mm) Ladder Keeper

- 1-3/8" (35 mm) Diameter Alloy 316 Brushed Stainless Steel Tubing

new

This Ladder Keeper is designed to work with Cat. No. LLP084BS Locking Ladder Pulls only when used with a glass transom. Intended for use with 3/8" to 1/2" (10 to 12 mm) tempered glass. Brushed stainless steel finish to complement the Locking Ladder Pulls. Please visit crlaurence.com for information on Cat. No. USW10 Universal Spanner Wrench. Minimum order is one each.

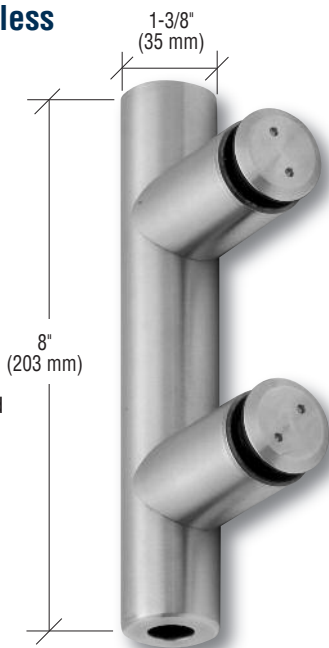

CAT. NO. LPK1BS

CRL 1" (25 mm) Ladder Keeper

- 1" (25 mm) Diameter Alloy 316 Brushed Stainless Steel Tubing

new

This Ladder Keeper is designed to work with Cat. No.'s LLP084TLBS, LLP084TRBS, and LLP024BS Locking Ladder Pulls only when used with a glass transom or sidelite. Intended for use with 3/8" to 1/2" (10 to 12 mm) tempered glass. Brushed stainless steel finish to complement the Locking Ladder Pulls. Please visit crlaurence.com for information on Cat. No. USW10 Universal Spanner Wrench. Minimum order is one each.

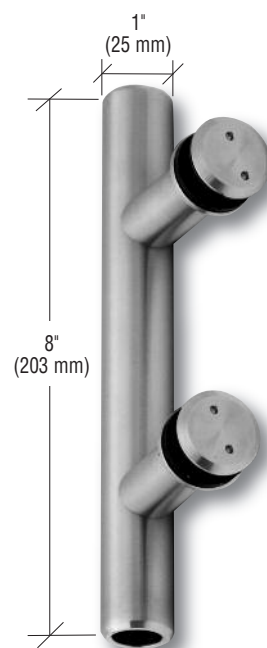

CAT. NO. LPK4BS

CRL 1-3/8" (35 mm) Single Hole Keeper

- 1-3/8" (35 mm) Diameter Alloy 316 Brushed Stainless Steel Tubing



new

This Keeper only requires a single hole in the glass. It is designed to work with Cat. No. LLP084BS Locking Ladder Pulls only when used with a glass transom. Intended for use with 3/8" to 1/2" (10 to 12 mm) tempered glass. Brushed stainless steel finish to complement the Locking Ladder Pulls. Please visit crlaurence.com for information on Cat. No. USW10 Universal Spanner Wrench. Minimum order is one each.

CAT. NO. LPK2BS

CRL Dustproof Keeper

new

- For CRL Locking Ladder Pulls
- Accepts 5/8" (16 mm) Throw Bolt
- Alloy 316 Brushed Stainless Steel

Our new Dustproof Keeper is intended to work with all CRL Locking Ladder Pulls with a concealed deadbolt locking mechanism. Brushed stainless steel finish. Requires a hole 1" (25 mm) in diameter by 1-7/8" (48 mm) deep. Minimum order is one each.

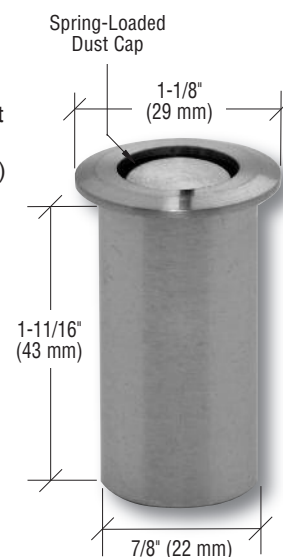
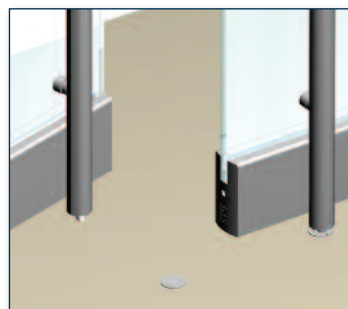

CAT. NO. 58DKBS

CRL One and Two Point Center Locks With Bottom Rail Extension Rod Throw

- Lets You Lock Doors at a Comfortable Height
- Secures 'All-Glass' Doors Better Than Ever Before
- One and Two Point Locking Options Available

We have expanded our Center Lock line by adding a new series of 4" x 10" Center Locks and Center Lock Glass Keepers that allow you to secure your 'all-glass' doors easier than ever before.

This innovative new series allows for one point and two point locking of 'all-glass' doors. Unlike previous two point locking applications that force you to reach for the bottom rail of the door, our system allows you to operate the lock at a comfortable 36" to 42" (914 to 1067 mm) above the floor. No more bending or kneeling. Simply turn the key or thumbturn found on the Center Lock and your door is locked into the floor (one point), or locked into the floor and jamb or Glass Mounted Keeper (two points).

For additional information or assistance in choosing the right Center Lock for your application, contact CRL Technical Sales at (800) 421-6144 in the U.S., (877) 421-6144 from Canada, or (323) 588-1281 International, and ask for Ext. 7700. You can also send e-mail from the crlaurence.com home page. Click on Contact Us, and then click on Technical Sales for Commercial Products.

new

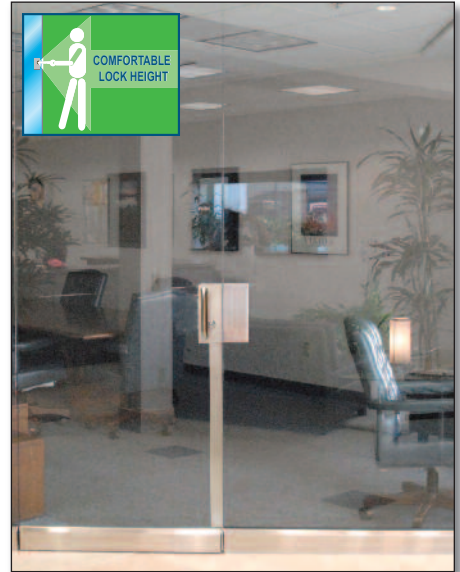

CRL Two Point Center Lock with Optional DEK4102 Series Glass Keeper

CRL One Point Center Lock With Bottom Rail Extension Rod Throw

- Available With or Without Back-to-Back "D" Handle
- Completely Fabricated and Ready to Install
- Available in Five Standard Architectural Finishes
- Custom Finishes Available on Special Order
- For 1/2" (12 mm) Tempered Glass

new



This 4" x 10" Center Lock has an extended throw that latches through the bottom door rail and into the floor. It is completely activated at a comfortable distance above the floor utilizing a built-in Adams Rite 1860-02 Lock with a modified extension rod allowing the throw to enter the floor. A small edge channel that travels down from the Center Lock to the bottom rail conceals the extension rod. The Center Lock is non-handed, with a Thumbturn for the inside, and a Keyed Cylinder for the outside. You can order them with or without an 8" (203 mm) back-to-back "D" Handle.

ORDERING NOTE: This innovative system is intended for the fabrication of new doors only. Retrofit applications are not recommended because the bottom door rail must be factory-modified to accept the Extension Rod Throw, and the door glass requires a specially shaped cut-out to accept the Center Lock. Please contact Technical Sales for Commercial Products for ordering assistance.

NOTE: In applications where A.D.A. Codes are a concern, a 10" (254 mm) tall bottom rail should be used with this Center Lock.

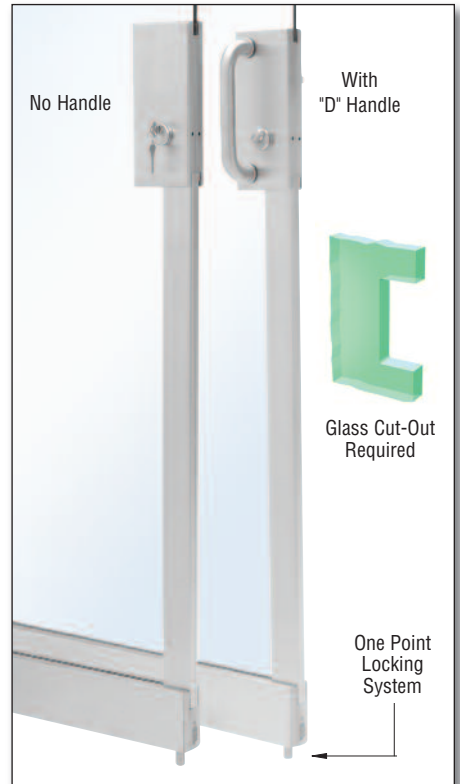

NO HANDLE CAT. NO.	WITH "D" HANDLE CAT. NO.	FINISH
DE4100BS	DE4101BS	Brushed Stainless
DE4100PS	DE4101PS	Polished Stainless
DE4100PB	DE4101PB	Polished Brass
DE4100SC	DE4101SC	Satin Anodized
DE4100DU	DE4101DU	Black Bronze Anodized

Minimum order: 1 each. All Center Locks can be combined for quantity pricing.



CRL Two Point Center Lock With Bottom Rail Extension Rod Throw

- Completely Fabricated and Ready to Install
- Available in Five Standard Architectural Finishes
- Custom Finishes Available on Special Order
- For 1/2" (12 mm) Tempered Glass

This 4" x 10" Center Lock has two throws, an extended throw that latches through the bottom door rail into the floor, and a horizontal throw that latches into the jamb or adjacent Glass Mount Keeper (sold separately, see crlaurence.com). It is completely activated at a comfortable distance above the floor utilizing a built-in Adams Rite 1860-02 Lock with a modified extension rod allowing the throw to enter the floor. A small edge channel that travels down from the Center Lock to the bottom rail conceals the extension rod. It includes an 8" (203 mm) back-to-back "D" Handle, a Thumbturn on the inside, and a Keyed Cylinder on the outside. 'No handle' option available on special order.

ORDERING NOTE: This innovative system is intended for the fabrication of new doors only. Retrofit applications are not recommended because the bottom door rail must be factory-modified to accept the Extension Rod Throw, and the door glass requires a specially shaped cut-out to accept the Center Lock. Please contact Commercial Products Technical Sales for ordering assistance. **NOTE:** In applications where A.D.A. Codes are a concern, a 10" (254 mm) tall bottom rail should be used with this Center Lock.

CAT. NO.	HANDING	FINISH
DE4102BS	Non-Handed	Brushed Stainless
DE4102PS	Non-Handed	Polished Stainless
DE4102PB	Non-Handed	Polished Brass
DE4102SC	Non-Handed	Satin Anodized
DE4102DU	Non-Handed	Black Bronze Anodized

Minimum order: 1 each. All Center Locks can be combined for quantity pricing.



new



CRL One Point Center Lock Plus Keeper With Bottom Rail Extension Rod Throw

- Perfect Solution for Double Doors
- Available in Five Standard Architectural Finishes
- Completely Fabricated and Ready to Install
- For 1/2" (12 mm) Tempered Glass

This 4" x 10" Center Lock has an extended throw that latches through the bottom door rail into the floor, and a strike for the horizontal throw from adjacent Center Lock (sold separately, see above). It is completely activated at a comfortable distance above the floor utilizing a built-in Adams Rite 1860-02 Lock with a modified extension rod allowing the throw to enter the floor. A small edge channel that travels down from the Center Lock to the bottom rail conceals the extension rod. It includes an 8" (203 mm) back-to-back "D" Handle, a Thumbturn on the inside, and a Keyed Cylinder on the outside. 'No handle' option available on special order.

ORDERING NOTE: This innovative system is intended for the fabrication of new doors only. Retrofit applications are not recommended because the bottom door rail must be factory-modified to accept the Extension Rod Throw, and the door glass requires a specially shaped cut-out to accept the Center Lock. Please contact Commercial Products Technical Sales for ordering assistance. **NOTE:** In applications where A.D.A. Codes are a concern, a 10" (254 mm) tall bottom rail should be used with this Center Lock.

CAT. NO.	HANDING	FINISH
DE4103BS	Non-Handed	Brushed Stainless
DE4103PS	Non-Handed	Polished Stainless
DE4103PB	Non-Handed	Polished Brass
DE4103SC	Non-Handed	Satin Anodized
DE4103DU	Non-Handed	Black Bronze Anodized

Minimum order: 1 each. All Center Locks can be combined for quantity pricing.



new





CRL Center Locks

- Available in Two Sizes: 4" x 10" and 6" x 10"
- Choose From Three Types: Deadlatch, Long Throw Deadlock, and Hook Throw Deadlock
- For Use With 1/2" (12 mm) Tempered Glass; Custom Sizes for Other Glass Thicknesses Available on Special Order
- Installs Easily With Bolts; No Messy Silicone or Cement Required
- Available in Five Stock Finishes Plus Custom Finishes on Special Order



CRL Center Locks are available in three types: Deadlatch, Long Throw Deadlock, and Hook Throw Deadlock. A variety of pull handles and latch-operating devices (Thumbturns, Keyed Cylinders, Lever Handles, and Paddle Handles) are available to accommodate different requirements.

We carry stock units for immediate shipment, and can fabricate custom units that can be shipped within one week. CRL Offers an easy-to-use ordering menu that takes you through all the required information needed to produce your Center Lock. It can be faxed or e-mailed to you, or accessed at crlaurence.com.

CRL 4" x 10" Center Lock Strikes

- Brushed Stainless Steel
- Dust Box and Back-Up Plate Included
- Non-Handed



CRL 4" x 10" Center Lock Strikes come with all necessary hardware for mounting. A back-up plate is included for use in aluminum tubes, along with a dust box. Choose from three sizes for various jamb widths. One per package.

SMALL 1-3/4" WIDE JAMB CAT. NO.	MEDIUM 4" WIDE JAMB CAT. NO.	LARGE 4-1/2" WIDE JAMB CAT. NO.	FINISH
DL4515	DL4540	DL4545	Brushed Stainless

Minimum order: 1 each. All Center Locks Strikes can be combined for quantity pricing.

CRL 4" x 10" Center Lock Glass Keepers

- For Use With 1/2" (12 mm) Tempered Glass
- Installs Easily With Bolts; No Silicone or Cement Required
- Non-Handed Stock Models Available in Five Standard Finishes
- Custom Sizes for Other Glass Thicknesses and Custom Finishes Can Be Special Ordered



Non-Handed

CRL 4" x 10" Center Lock Glass Keepers have a Strike Plate with a latch entry ramp on both sides, making them universal for all applications. Available in five attractive finishes for 1/2" (12 mm) heavy glass doors. Glass Keepers With Deadlatch Electric Strikes are available on special order.

CAT. NO.	HANDING	FINISH
DLK410BS	Non-Handed	Brushed Stainless
DLK410PS	Non-Handed	Polished Stainless
DLK410PB	Non-Handed	Polished Brass
DLK410SC	Non-Handed	Satin Anodized
DLK410DU	Non-Handed	Black Bronze Anodized



Glass Cut-Out Required

Minimum order: 1 each. All Center Locks and Keepers can be combined for quantity pricing.

CRL 4" x 10" Center Locks With Deadlatch

- For Use With 1/2" (12 mm) Tempered Glass
- Installs Easily With Bolts; No Silicone or Cement Required
- Available in Five Stock Finishes
- Custom Sizes for Other Glass Thicknesses and Custom Finishes Can Be Special Ordered



RH/LHR Shown

CRL 4" x 10" Center Locks With Deadlatch come with a Deadlatch that can be dogged in the open position, an 8" (203 mm) Back-to-Back "D" Handle, a Thumbturn on the inside, and a Keyed Cylinder on the outside. The dogging feature is engaged by simply pushing both deadlatch bolts fully into the open position, then engaging the dogging clips by turning either the Keyed Cylinder or Thumbturn until the clips snap in place.

Available in five attractive finishes for 1/2" (12 mm) heavy glass doors. Custom Locks with different accessories are available on special order.

LH/RHR* CAT. NO.	RH/LHR* CAT. NO.	FINISH
DL410LBS	DL410RBS	Brushed Stainless
DL410LPS	DL410RPS	Polished Stainless
DL410LPB	DL410RPB	Polished Brass
DL410LSC	DL410RSC	Satin Anodized
DL410LDU	DL410RDU	Black Bronze Anodized



Glass Cut-Out Required

Minimum order: 1 each. *See page L214 for handing chart. All Center Locks and Keepers can be combined for quantity pricing.

CRL 4" x 10" Center Locks With Long Throw Deadlock



- Non-Handed Stock Models Available in Five Finishes
- Installs Easily With Bolts; No Silicone or Cement Required
- For Use With 1/2" (12 mm) Tempered Glass
- Custom Sizes for Other Glass Thicknesses Are Available on Special Order



Non-Handed



Glass Cut-Out Required

4" x 10" Center Locks With Long Throw Deadlock include a DL2110 Long Throw Deadlock, an 8" (203 mm) back-to-back "D" Handle, a Thumbturn on the inside, and a Keyed Cylinder on the outside.

CAT. NO.	FINISH
DT410BS	Brushed Stainless
DT410PS	Polished Stainless
DT410PB	Polished Brass
DT410SC	Satin Anodized
DT410DU	Black Bronze Anodized

Minimum order: 1 each. All Center Locks and Keepers can be combined for quantity pricing.

CRL 4" x 10" Center Locks With Hook Throw Deadlock



- Non-Handed Stock Models Available in Five Finishes
- Installs Easily With Bolts; No Silicone or Cement Required
- For Use With 1/2" (12 mm) Tempered Glass
- Custom Sizes for Other Glass Thicknesses Are Available on Special Order



Non-Handed



Glass Cut-Out Required

4" x 10" Center Locks With Hook Throw Deadlock include a DL2130 Hook Throw Deadlock, an 8" (203 mm) back-to-back "D" Handle, a Thumbturn on the inside, and a Keyed Cylinder on the outside.

CAT. NO.	FINISH
DH410BS	Brushed Stainless
DH410PS	Polished Stainless
DH410PB	Polished Brass
DH410SC	Satin Anodized
DH410DU	Black Bronze Anodized

Minimum order: 1 each. All Center Locks and Keepers can be combined for quantity pricing.

CRL 4" x 10" Glass Keepers for Center Locks With Long Throw Deadlock

- Non-Handed Stock Models Available in Five Finishes
- Installs Easily With Bolts; No Silicone or Cement Required
- For Use With 1/2" (12 mm) Tempered Glass
- Custom Sizes for Other Glass Thicknesses Are Available on Special Order



Non-Handed



Glass Cut-Out Required

Non-Handed 4" x 10" Glass Keepers for the 4" x 10" Long Throw and Hook Throw Deadlocks. Available in five finishes for 1/2" (12 mm) heavy glass doors.

CAT. NO.	FINISH
DTK410BS	Brushed Stainless
DTK410PS	Polished Stainless
DTK410PB	Polished Brass
DTK410SC	Satin Anodized
DTK410DU	Black Bronze Anodized

Minimum order: 1 each. All Center Locks and Keepers can be combined for quantity pricing.

CRL 4" x 10" Glass Keepers for DE4102 Series Center Locks

- Non-Handed Stock Models Available in Five Finishes for 1/2" (12 mm) Tempered Glass
- Installs Easily With Bolts; No Silicone or Cement Required
- Custom Sizes Available on Special Order for Other Glass Thicknesses



Non-Handed



Glass Cut-Out Required

These non-handed 4" x 10" Glass Keepers are for use on glass panels adjacent to swinging doors using our DE4102 Series Two-Point Center Locks (see page L211).

CAT. NO.	FINISH
DEK4102BS	Brushed Stainless
DEK4102PS	Polished Stainless
DEK4102PB	Polished Brass
DEK4102SC	Satin Anodized
DEK4102DU	Black Bronze Anodized

Minimum order: 1 each. All Center Locks and Keepers can be combined for quantity pricing.

CRL 6" x 10" Center Locks With Deadlatch

- Five Different Lock Functions Available; Office, Entrance, Passage, Storeroom, and Classroom
- For 1/2" (12 mm) Tempered Glass; Custom Units for Other Glass Thicknesses on Special Order
- Ships in Under a Week
- Available in Five Finishes
- Hassle Free Installation Without the Mess of Cement or Silicone
- Jamb Mount Strike Plates on Special Order

6" x 10" Center Locks with Deadlatch offer the most diversity in lock function and security. Available in five attractive finishes for 1/2" (12 mm) heavy glass doors. The operation of the lock varies with the lock function. A simple cut-out in the glass is all that is required. No messy cement or silicone required for installing. Center Locks are available left and right handed (see reference diagram below).

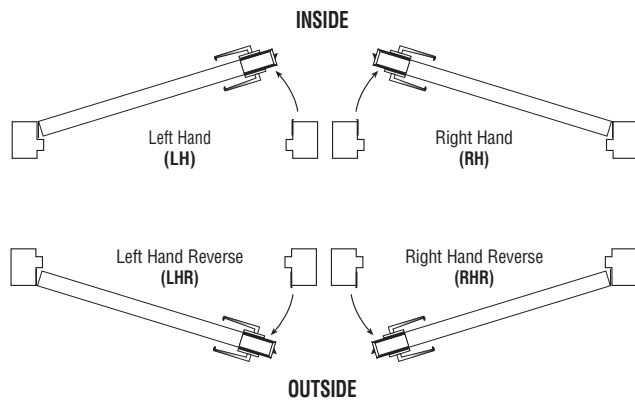

CRL 6" x 10" Center Office Lock

With an "Office Lock", the Latchbolt is operated by lever on either side (except when outside lever is locked by rocker in faceplate) or by a key outside. Auxiliary Latchbolt deadlocks the main Latchbolt to prevent jimmying of lock. Turning inside lever will always retract the locking mechanism and allow exiting.



OFFICE LOCK

LH CAT. NO.	RH CAT. NO.	LHR CAT. NO.	RHR CAT. NO.	FINISH
DL610LOBS	DL610ROBS	DL611LOBS	DL611ROBS	Brushed Stainless
DL610LOPS	DL610ROPS	DL611LOPS	DL611ROPS	Polished Stainless
DL610LOPB	DL610ROPB	DL611LOPB	DL611ROPB	Polished Brass
DL610LOSC	DL610ROSC	DL611LOSC	DL611ROSC	Satin Anodized
DL610LODU	DL610RODU	DL611LODU	DL611RODU	Black Bronze Anodized

Minimum order: 1 each. All Center Locks and Keepers can be combined for quantity pricing.

CRL 6" x 10" Center Entrance Lock

With an "Entrance Lock", the Latchbolt is operated by lever on either side (except when outside lever is locked by rocker in faceplate). Deadbolt is operated by key outside and thumbturn inside. Inside lever operates Latchbolt and Deadbolt simultaneously to allow exiting.

NOTE: Will not work with Electric Strikes.



ENTRANCE LOCK (WILL NOT WORK WITH ELECTRIC STRIKE)

LH CAT. NO.	RH CAT. NO.	LHR CAT. NO.	RHR CAT. NO.	FINISH
DL610LEBS	DL610REBS	DL611LEBS	DL611REBS	Brushed Stainless
DL610LEPS	DL610REPS	DL611LEPS	DL611REPS	Polished Stainless
DL610LEPB	DL610REPB	DL611LEPB	DL611REPB	Polished Brass
DL610LESC	DL610RESC	DL611LESC	DL611RESC	Satin Anodized
DL610LEDU	DL610REDU	DL611LEDU	DL611REDU	Black Bronze Anodized

Minimum order: 1 each. All Center Locks and Keepers can be combined for quantity pricing.

CRL 6" x 10" Center Passage Lock

With a "Passage Lock", the levers are always operable, allowing the Latchbolt to be retracted at all times.



LHR Shown

PASSAGE LOCK

LH CAT. NO.	RH CAT. NO.	LHR CAT. NO.	RHR CAT. NO.	FINISH
DL610LPBS	DL610RPBS	DL611LPBS	DL611RPBS	Brushed Stainless
DL610LPPS	DL610RPPS	DL611LPPS	DL611RPPS	Polished Stainless
DL610LPPB	DL610RPPB	DL611LPPB	DL611RPPB	Polished Brass
DL610LPSC	DL610RPSC	DL611LPSC	DL611RPSC	Satin Anodized
DL610LPDU	DL610RPDU	DL611LPDU	DL611RPDU	Black Bronze Anodized

Minimum order: 1 each. All Center Locks and Keepers can be combined for quantity pricing.

CRL 6" x 10" Center Storeroom Lock

With a "Storeroom Lock", the Latchbolt is operated by lever inside, and by key outside. The outside lever is always fixed. Auxiliary Latchbolt deadlocks the main Latchbolt to prevent jimmying of lock. Turning inside lever will always retract the locking mechanism to allow exiting. This lock is used primarily with Electric Strikes.



LHR Shown

STOREROOM LOCK

LH CAT. NO.	RH CAT. NO.	LHR CAT. NO.	RHR CAT. NO.	FINISH
DL610LSBS	DL610RSBS	DL611LSBS	DL611RSBS	Brushed Stainless
DL610LSPS	DL610RSPS	DL611LSPS	DL611RSPS	Polished Stainless
DL610LSPB	DL610RSPB	DL611LSPB	DL611RSPB	Polished Brass
DL610LSSC	DL610RSSC	DL611LSSC	DL611RSSC	Satin Anodized
DL610LSDU	DL610RSDU	DL611LSDU	DL611RSDU	Black Bronze Anodized

Minimum order: 1 each. All Center Locks and Keepers can be combined for quantity pricing.

CRL 6" x 10" Center Classroom Lock

With a "Classroom Lock", the Latchbolt is operated by lever either side except when outside lever is locked by Key outside. Key operates latch or unlocks outside lever. Inside lever is always operable.



LHR Shown

CLASSROOM LOCK

LH CAT. NO.	RH CAT. NO.	LHR CAT. NO.	RHR CAT. NO.	FINISH
DL610LMBS	DL610RMBS	DL611LMBS	DL611RMBS	Brushed Stainless
DL610LMPS	DL610RMPS	DL611LMPS	DL611RMPS	Polished Stainless
DL610LMPB	DL610RMPB	DL611LMPB	DL611RMPB	Polished Brass
DL610LMSC	DL610RMSC	DL611LMSC	DL611RMSC	Satin Anodized
DL610LMDU	DL610RMDU	DL611LMDU	DL611RMDU	Black Bronze Anodized

Minimum order: 1 each. All Center Locks and Keepers can be combined for quantity pricing.

CRL 6" x 10" Center Push Button Locks and Glass Keepers

- Requires No Electrical Connections
- Complies With A.D.A. Standards
- Five Finishes Available

new



CRL Push Button Lock and Glass Keeper assemblies require no electrical connections so the mounting is exactly the same as our other 6" x 10" Center Locks. On the exterior side of the door is a Keypad with five vertical push buttons, numbered in sequential order from top to bottom. On the interior side there is a lever, which operates the Latchbolt at all times.

The lock complies with A.D.A. standards and is ideal for high frequency use in hospitals, entrances to commercial and industrial buildings, apartments, condominiums, schools, etc.

The Center Lock Glass Keeper (sold separately) is specially machined to accept the strike from the Push Button Lock. If a Center Lock Glass Keeper is not required a Strike Plate for the jamb is supplied with the Push Button Lock assembly.



PUSH BUTTON LOCKS*

LH CAT. NO.	RH CAT. NO.	LHR CAT. NO.	RHR CAT. NO.	FINISH
DL610LCBS	DL610RCBS	DL611LCBS	DL611RCBS	Brushed Stainless
DL610LCPS	DL610RCPS	DL611LCPS	DL611RCPS	Polished Stainless
DL610LCPB	DL610RCPB	DL611LCPB	DL611RCPB	Polished Brass
DL610LCSC	DL610RCSC	DL611LCSC	DL611RCSC	Satin Anodized
DL610LCDU	DL610RCDU	DL611LCDU	DL611RCDU	Black Bronze Anodized

Minimum order: 1 each. All Center Locks and Keepers can be combined for quantity pricing.

▼ Black Bronze Cover Plate with Satin Anodized Lock and Lever.

* Push Button Lock and Glass Keeper are sold separately.

CENTER LOCK GLASS KEEPERS*

LH CAT. NO.	RH CAT. NO.	FINISH
DLK610LCBS	DLK610RCBS	Brushed Stainless
DLK610LCPS	DLK610RCPS	Polished Stainless
DLK610LCPB	DLK610RCPB	Polished Brass
DLK610LCSC	DLK610RCSC	Satin Anodized
DLK610LCDU	DLK610RCDU	Black Bronze Anodized

Minimum order: 1 each. All Center Locks and Keepers can be combined for quantity pricing.

* Push Button Lock and Glass Keeper are sold separately.

CRL 4" x 10" Center Lock Glass Keepers With Deadlatch Electric Strike

- Accepts 1/2" (12 mm) Tempered Glass
- Available in Five Finishes

4" x 10" Center Lock Glass Keepers with Deadlatch Electric Strike are handed to match the appropriate Center Lock. To simplify ordering use the same handing as the lock. That way you match the Glass Keeper with Deadlatch Electric Strike to Center Lock handing, which eliminates confusion. These units are special order and can be shipped within one week. For more information, contact CRL Technical Sales at (800) 421-6144 in the U.S., (877) 421-6144 from Canada, or (323) 588-1281 International, and ask for Ext. 7700. You can also e-mail us through our web site at crlaurence.com. From the home page click on Contact Us, and then click on Technical Sales for Commercial Products.



RH/LHR Shown



Glass Cut-Out Required

LH/RHR* CAT. NO.	RH/LHR* CAT. NO.	FINISH
DLEL410BS	DLER410BS	Brushed Stainless
DLEL410PS	DLER410PS	Polished Stainless
DLEL410PB	DLER410PB	Polished Brass
DLEL410SC	DLER410SC	Satin Anodized
DLEL410DU	DLER410DU	Black Bronze Anodized

Minimum order: 1 each. *See page L214 for handing chart. All Center Locks and Keepers can be combined for quantity pricing. Extra gaskets available on special order for use with 3/8" (10 mm) glass.

CRL 6" x 10" Center Lock Glass Keepers With Deadlatch Electric Strike

- Accepts 1/2" (12 mm) Tempered Glass
- Ships In Under a Week
- Available in Five Finishes

6" x 10" Center Lock Glass Keepers with Deadlatch Electric Strike are handed to match the appropriate Center Lock. To simplify ordering use the same handing as the lock. That way you match the Glass Keeper with Deadlatch Electric Strike to Center Lock handing, which eliminates confusion. NOTE: Will not work with Entrance Lock configuration. These units are special order and can be shipped within one week. Please contact Technical Sales at (800) 421-6144 in the U.S., (877) 421-6144 from Canada, or (323) 588-1281 International, and ask for Ext. 7700.



RH/LHR Shown



Glass Cut-Out Required

LH/RHR* CAT. NO.	RH/LHR* CAT. NO.	FINISH
DLEL610BS	DLER610BS	Brushed Stainless
DLEL610PS	DLER610PS	Polished Stainless
DLEL610PB	DLER610PB	Polished Brass
DLEL610SC	DLER610SC	Satin Anodized
DLEL610DU	DLER610DU	Black Bronze Anodized

Minimum order: 1 each. *See page L214 for handing chart. All Center Locks and Keepers can be combined for quantity pricing. Extra gaskets available on special order for use with 3/8" (10 mm) glass.

CRL 6" x 10" Center Lock Glass Keepers

- Installs Easily With Bolts; No Silicone or Cement Required
- Available in Five Popular Finishes
- For 1/2" (12 mm) Tempered Glass

6" x 10" Center Lock Glass Keepers have a strike plate with a latch entry ramp on both sides, making them universal for all applications. Available in five attractive finishes for 1/2" (12 mm) tempered glass doors. For more information, contact CRL Technical Sales at (800) 421-6144 in the U.S., (877) 421-6144 from Canada, or (323) 588-1281 International, and ask for Ext. 7700. You can also e-mail us through our web site at crlaurence.com. From the home page click on Contact Us, and then click on Technical Sales for Commercial Products.



Non-Handed



Glass Cut-Out Required

ENTRANCE LOCK* CAT. NO.	FOR OTHER LOCKS CAT. NO.	FINISH
DLK610EBS	DLK610BS	Brushed Stainless
DLK610EPS	DLK610PS	Polished Stainless
DLK610EPB	DLK610PB	Polished Brass
DLK610ESC	DLK610SC	Satin Anodized
DLK610EDU	DLK610DU	Black Bronze Anodized

Minimum order 1 each. All Center Locks and Keepers can be combined for quantity pricing. *Used only with Entrance Locks.

CRL 6" x 10" Center Lock Strikes

- Available to Fit Four Different Jamb Sizes
- Dust Box and Back-Up Plate Included
- Left and Right Handed Models
- Brushed Stainless Steel

new



DLL6515 Shown

CRL 6" x 10" Center Lock Strikes come with all the necessary hardware for mounting. A Back-Up Plate is included for use in aluminum tubes, along with a Dust Box. Choose from two models and four different jamb widths.

FOR OFFICE, PASSAGE, STOREROOM, AND CLASSROOM CENTER LOCKS

LH/RHR* CAT. NO.	RH/LHR* CAT. NO.	FITS JAMB SIZE
DLL6515	DLR6515	1-3/4" (45 mm)
DLL6540	DLR6540	4" (102 mm)
DLL6545	DLR6545	4-1/2" (114 mm)
DLL6560	DLR6560	6" (152 mm)

FOR ENTRANCE CENTER LOCKS (DEADBOLT)

LH/RHR* CAT. NO.	RH/LHR* CAT. NO.	FITS JAMB SIZE
DLL6615	DLR6615	1-3/4" (45 mm)
DLL6640	DLR6640	4" (102 mm)
DLL6645	DLR6645	4-1/2" (114 mm)
DLL6660	DLR6660	6" (152 mm)

Minimum order: 1 each. *See page L214 for handing chart. All Strikes can be combined for quantity pricing.

CRL Small Format Interchangeable Cores (SFIC) and Housings

CRL 7-Pin Small Format Interchangeable Cores (SFIC)

- Works With CRL Locking Ladder Pulls, Wedge-Lock™ Door Rails, 4" x 10" and 6" x 10" Center Locks, and CRL Panic and Deadbolt Devices
- 7-Pin Type Core
- Brushed Nickel Finish
- Available in 10 Different Key Configurations
- Master Keying Available on Special Order

CRL now stocks 7-Pin Small Format Interchangeable Cores (SFIC) to provide easy key control among end users on many of our products, as well as on Best, Falcon, Schlage, etc. interchangeable core systems. CRL 7-Pin Cores are the perfect choice for end users that want key control in SFIC hardware applications.

CRL Interchangeable Cores can be easily extracted from their housings via a special 'control key' for easy replacement or re-keying.

CAT. NO.	KEY NUMBER	CAT. NO.	KEY NUMBER
1C01	1	1C06	6
1C02	2	1C07	7
1C03	3	1C08	8
1C04	4	1C09	9
1C05	5	1C10	10

Minimum order: 1 each. All SFIC Cores can be combined for quantity pricing.

Minimum order: 1 each. All SFIC Cores can be combined for quantity pricing.

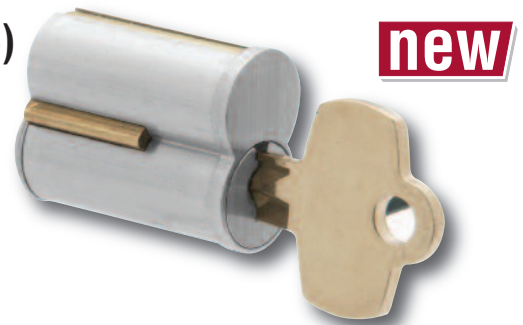

ORDERING INFORMATION:

- Each Core comes with one Control Key and two Operate Keys
- Mortise Housings not included and must be ordered separately (see below). **NOTE:** When used with CRL Locking Ladder Pulls, Mortise Housings are not required.
- Not compatible with larger 'removable' core systems.
- When used with CRL Low Profile Wedge-Lock™ Door Rails an additional DRA256 Series Cylinder Ring must be ordered separately.

CRL Mortise Housing for 7-Pin Small Format Interchangeable Cores (SFIC)

- Compatible With Any 7-Pin SFIC Type Core
- Available in Five Architectural Finishes

CRL Mortise Housings for 7-Pin Small Format Interchangeable Cores (SFIC) are used to replace any of our Mortise Keyed Cylinders with an 'interchangeable core' system. Easily convert any of our Door Rails with locks, Locking Ladder Pulls, 4" x 10" and 6" x 10" Center Locks, or Panic and Deadbolt Handles to an 'interchangeable' core system. Simply remove the existing mortise cylinder and replace with a new Housing and Core, it's that easy!

CAT. NO.	FINISH
1CHBS	Brushed Stainless
1CHDU	Black/Bronze Anodized
1CHPB	Polished Brass
1CHPS	Polished Stainless
1CHSA	Satin Anodized

Minimum order: 1 each. Finishes can be combined for quantity pricing.

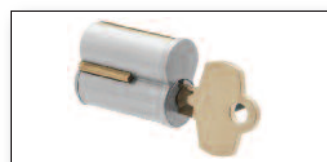

Cores must be ordered separately



ORDERING INFORMATION:

- Each Housing comes with a 1/2" (12 mm) tall cylinder ring.
- SFIC Cores must be ordered separately (see above). **NOTE:** When used with CRL Locking Ladder Pulls, Mortise Housings are not required.
- Not compatible with larger 'removable' core systems.
- When used with CRL Low Profile Wedge-Lock™ Door Rails an additional DRA256 Series Cylinder Ring must be ordered separately.

CRL Panic Handles

- **Manually Operated Roller Latch Bolt**
- **UL, ULC, and ANSI/BHMA Certified**
- **For 1/2" or 3/4" (12 or 19 mm) Tempered Glass Doors**
- **Wide Selection of Exterior Fixed Handles**
- **Available in Polished and Brushed Stainless, Satin and Polished Brass, and Oil Rubbed Bronze**
- **Custom Finishes Available By Special Order**
- **Custom Sizes Ship Within One to Two Weeks**
- **Models for Aluminum or Wood Doors Available on Special Order**



CRL manufactures a complete line of Panic Handles designed with the 'all-glass' door in mind. These elegant tubular devices give you maximum viewing area and a contemporary look when used on 1/2" or 3/4" (12 or 19 mm) tempered glass doors. The most popular of these Panics is our PA100 Series. They provide a solution to the strict Americans With Disabilities Act (A.D.A.) Codes that confront every manufacturer and installer of 'all-glass' doors. The interior portion of the device is a slender 1-1/4" (32 mm) tube stretching across the door and then gently turning upwards to the top of the door, eliminating any interference at the lower half of the door, which must remain clear of obstructions to pass A.D.A. demands. The operating mechanism is completely concealed within the tube, and retracts a roller latch bolt at the top of the door when pushed gently. Complementing the sleek interior look, we offer a large selection of exterior pull handles that can be as simple as a horizontal handle (Model PA100A) to one that mirrors the interior device (Model PA100D). All PA100 Series Panic Handles come with a 'dogging' feature that allows you to lock the device in the open position by simply sliding a lever, giving free access during business hours. They also can be used in conjunction with an Electric Strike, allowing for remote keyless entry. For your convenience, Custom Headers are available with all strike hardware installed.

When A.D.A. Codes are not a concern, we also offer our PA110 Series Panic Handles. These Panics are of the same sleek design as the PA100 Series, except they stretch across the door and then bend downward to the bottom of the door, latching at the floor or threshold. They operate just like the PA100 Series Panics, and have the same 'dogging' feature. Strikes are available for either threshold or no threshold applications providing secure, accurate latching every time.

All of our PA100 and PA110 Panic Handles go through rigorous testing before they leave our manufacturing facility, ensuring that a high quality, dependable Panic will serve your customer for years to come. Most importantly, they are all UL305, ULC/5132-93, and ANSI/BHMA A156.3-2001, Grade 1 Certified. For more information on Panic Handles, please visit our web site at crlaurence.com.

MAXIMUM DOOR HEIGHTS:

- Exterior - 96" (2.44 m) for 1/2" (12 mm) Glass Thickness
- 102" (2.59 m) for 3/4" (19 mm) Glass Thickness
- Interior - 102" (2.59 m) for 1/2" (12 mm) Glass Thickness
- 108" (2.74 m) for 3/4" (19 mm) Glass Thickness
- Exception - When using "F" Style Exterior Handle
- 108" (2.74 m) for either 1/2" or 3/4" (12 or 19 mm) Glass Thickness

SPECIFICATIONS:

- Material:** 1-1/4" (32 mm) Diameter Brass or Stainless Steel Tubing (1.5 mm thick)
- Glass Thicknesses:** 1/2" (12 mm) or 3/4" (19 mm)
- Glass Fabrication:** Please contact CRL Technical Sales
- Certification:** UL Classified
ULC/5132-93
ANSI/BHMA A156.3-2001 Grade 1

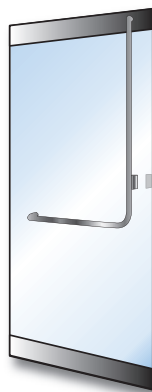

PANIC PA100
Latches at top only



PANIC PA110
Latches at bottom only



Contact CRL Technical Sales at (800) 421-6144 in the U.S., (877) 421-6144 from Canada, or (323) 588-1281 International, and ask for Ext. 7700. You can also send e-mail from the crlaurence.com home page. Click on Contact Us, and then click on Technical Sales for Commercial Products.

NOTE: All Access Control Handles on this page function as health and safety tools, and may only be purchased through CRL Authorized Glass Temperers and Door Manufacturers.

CRL Top Latching Panic Handle Details

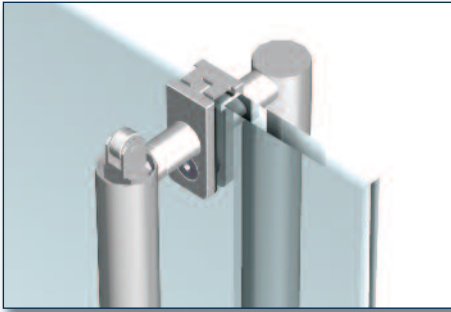

Glass Mount Detail at Latch

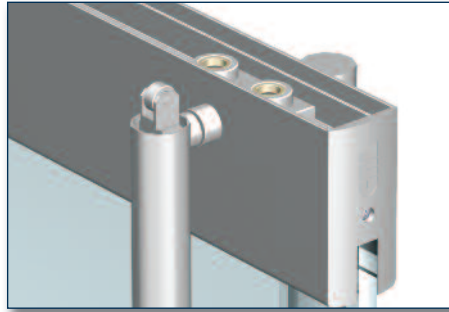

Rail Mount Detail at Latch



Keyed Access
(With Removable Core)

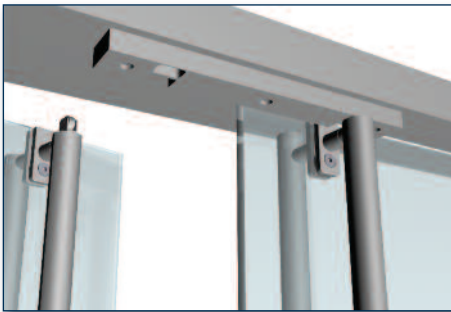

Glass Mount Detail at Latch With Header and PK Strike



Rail Mount Detail at Latch with Header and ESK Strike

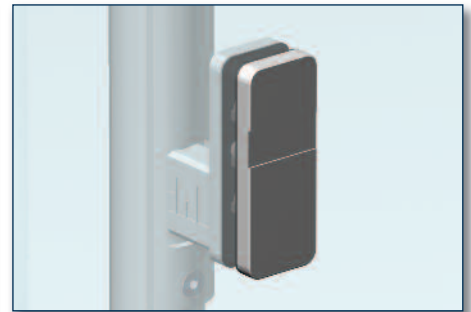

Retainer Plate

CRL Bottom Latching Panic Handle Details



Glass Mount Detail at Latch

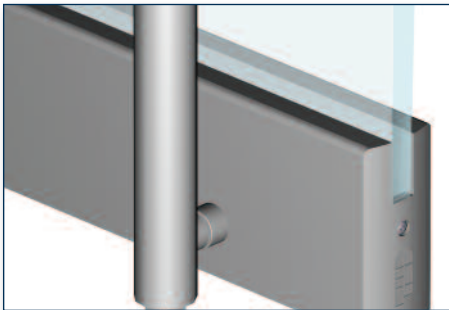

Rail Mount Detail at Latch



Keyed Access
(With Removable Core)

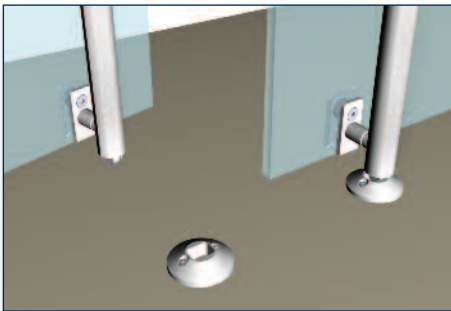

Glass Mount Detail at Latch With Floor Mount Ramp Strike

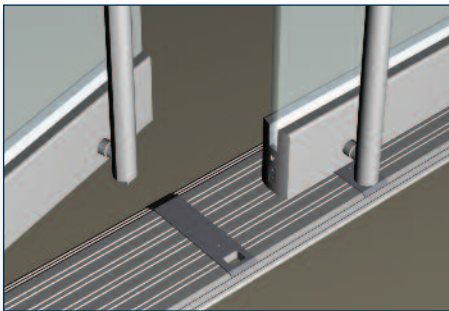

Rail Mount Detail at Latch With Threshold Ramp Strike

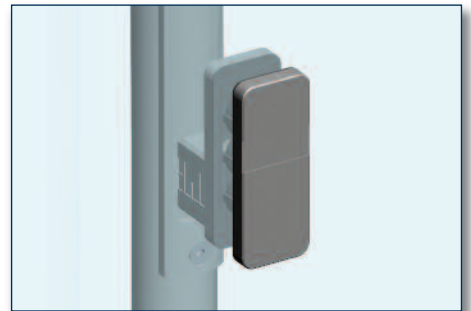

Retainer Plate

Contact CRL Technical Sales at (800) 421-6144 in the U.S., (877) 421-6144 from Canada, or (323) 588-1281 International, and ask for Ext. 7700. You can also send e-mail from the crlaurence.com home page. Click on Contact Us, and then click on Technical Sales for Commercial Products.

NOTE: All Access Control Handles on this page function as health and safety tools, and may only be purchased through CRL Authorized Glass Temperers and Door Manufacturers.

CRL Deadbolt Handles

- **Key or Thumbturn Activated Deadbolt**
- **UL Classified, ANSI Certified**
- **For 1/2" or 3/4" (12 or 19 mm) Tempered Glass Doors**
- **Wide Selection of Exterior Fixed Handles**
- **Available in Top Locking Only, Bottom Locking Only, or Both Top and Bottom Locking**
- **Available in Polished and Brushed Stainless, Satin and Polished Brass, and Oil Rubbed Bronze**
- **Custom Finishes Available By Special Order**
- **Custom Sizes Ship Within One to Two Weeks**
- **Models for Aluminum or Wood Doors Available on Special Order**



CRL manufactures a complete line of Deadbolt Handles designed to offer easily accessible locking hardware for 'all-glass' doors in an elegant tubular device, while maximizing your viewing area. Our Deadbolt Handles add a contemporary look to any 1/2" or 3/4" (12 or 19 mm) tempered glass door.

The interior portion of the device is a slender 1-1/4" (32 mm) tube. The locking hardware is completely concealed within the tube. The top deadbolt retracts with just a simple turn of a key or thumbturn conveniently located at a comfortable height above the finished floor. To complement the sleek interior look, we offer a variety of exterior pull handles that can be as simple as a horizontal handle or one that mirrors the interior device.

All top locking Deadbolt Handles can be used in conjunction with an Electric Strike, allowing for remote keyless entry. For your convenience, Custom Headers are available with all strike hardware installed.

Where A.D.A. Codes are not a concern, we offer our bottom locking Deadbolt Handles. These Deadbolts are of the same sleek design as the top locking Deadbolt Handles, except they Latch at the bottom of the door into the floor or threshold. Strikes are available for either threshold or no threshold applications, providing secure, accurate engagement of the deadbolt with every closing.

All of our Deadbolt Handles go through rigorous testing before they leave our manufacturing facility, ensuring that a high quality, dependable Deadbolt Handle is installed every time. Most importantly, they are all UL Classified to ANSI A156.16-1997 Standard. For more information on Deadbolt Handles, please visit our web site at crlaurence.com.

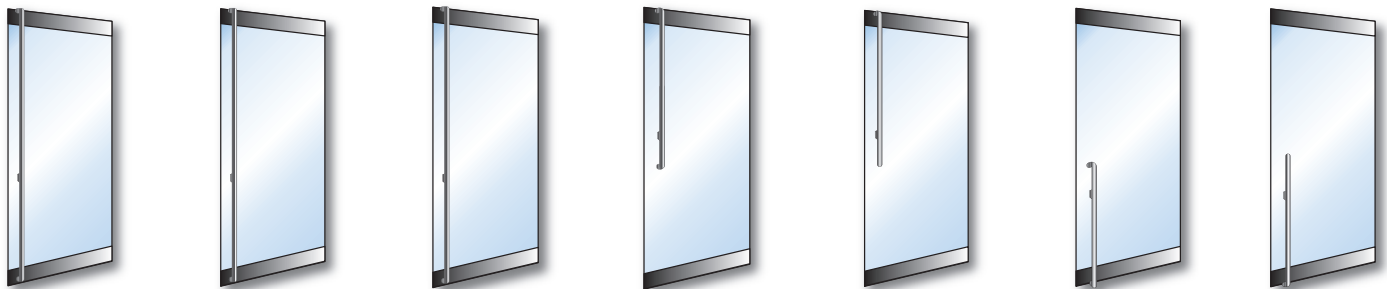

- | | | | | | | |
|--|---|--|--|--|---|---|
| DEADBOLT DB130
Locks at top only | DEADBOLT DB131
Locks at bottom only | DEADBOLT DB132
Locks at top and bottom | DEADBOLT DB160
Locks at top only | DEADBOLT DB170
Locks at top only | DEADBOLT DB150
Locks at bottom only | DEADBOLT DB140
Locks at bottom only |
|--|---|--|--|--|---|---|

MAXIMUM DOOR HEIGHTS:

- Exterior - 96" (2.44 m) for 1/2" (12 mm) Glass Thickness
- 102" (2.59 m) for 3/4" (19 mm) Glass Thickness
- Interior - 102" (2.59 m) for 1/2" (12 mm) Glass Thickness
- 108" (2.74 m) for 3/4" (19 mm) Glass Thickness
- Exception - When using "F" Style Exterior Handle
- 108" (2.74 m) for either 1/2" or 3/4" (12 or 19 mm) Glass Thickness

SPECIFICATIONS:

- Material:** 1-1/4" (32 mm) Diameter Brass or Stainless Steel Tubing (1.5 mm thick)
- Glass Thicknesses:** 1/2" (12 mm) or 3/4" (19 mm)
- Glass Fabrication:** Please contact CRL Technical Sales
- Certification:** UL Classified ANSI A156.16-1997



Contact CRL Technical Sales at (800) 421-6144 in the U.S., (877) 421-6144 from Canada, or (323) 588-1281 International, and ask for Ext. 7700. You can also send e-mail from the crlaurence.com home page. Click on Contact Us, and then click on Technical Sales for Commercial Products.

CRL Top Locking Deadbolt Handle Details

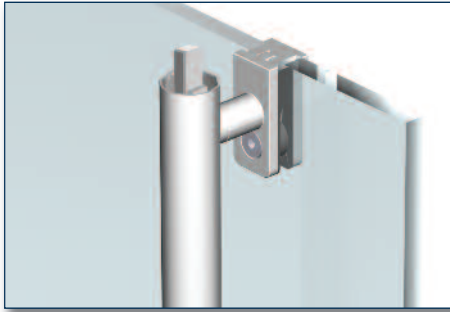

Glass Mount Detail at Latch

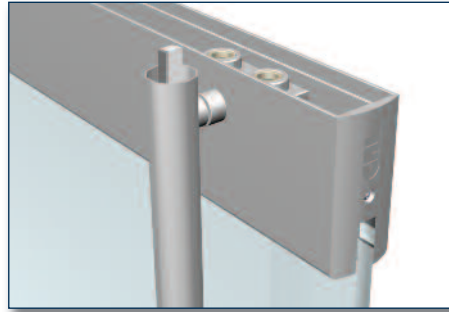

Rail Mount Detail at Latch



Keyed Access – Cylinder Out / Thumbturn In (With Removable Core)



Glass Mount Detail at Latch With Header and Hole for Latch



Rail Mount Detail at Latch With Header and PK Strike

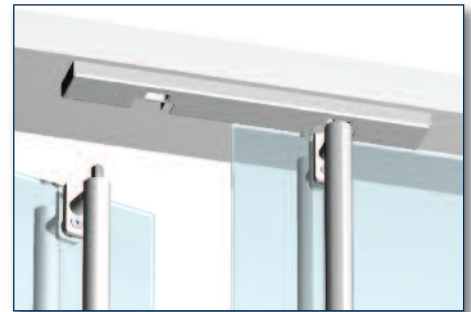

Glass Mount Detail at Latch With Header and ESK Strike

CRL Bottom Locking Deadbolt Handle Details



Glass Mount Detail at Latch

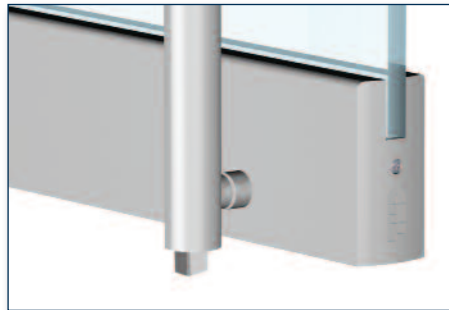

Rail Mount Detail at Latch



Keyed Access – Cylinder Out / Cylinder In (With Removable Core)

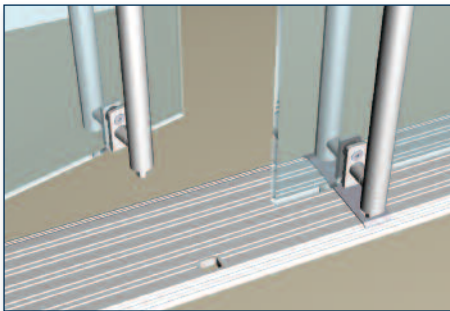

Glass Mount Detail at Latch With Threshold Prepped for Latch



Rail Mount Detail at Latch at Floor With AMR209PS Dustproof Keeper

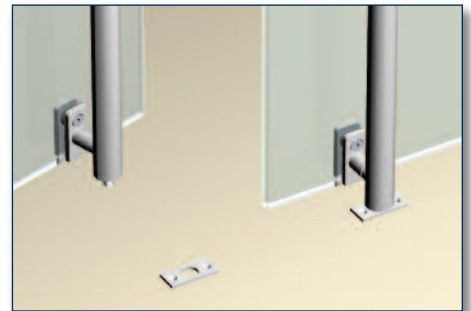

Glass Mount Detail at Latch at Floor With 777SP Flat Strike

Contact CRL Technical Sales at (800) 421-6144 in the U.S., (877) 421-6144 from Canada, or (323) 588-1281 International, and ask for Ext. 7700. You can also send e-mail from the crlaurence.com home page. Click on Contact Us, and then click on Technical Sales for Commercial Products.

CRL Electronic Egress Control Handles

- Works With Electromagnetic Locks
- UL and ULC Recognized Component
- For 1/2" or 3/4" (12 or 19 mm) Tempered Glass Doors
- Available in Polished and Brushed Stainless, Satin and Polished Brass, and Oil Rubbed Bronze
- Custom Finishes Available By Special Order
- Wide Selection of Exterior Fixed Handles
- Custom Sizes Ship Within One to Two Weeks
- Models for Aluminum or Wood Doors Available on Special Order



CALIFORNIA DEPARTMENT OF FORESTRY & FIRE PROTECTION
OFFICE OF THE STATE FIRE MARSHALL
FIRE ENGINEERING - BUILDING MATERIALS LISTING PROGRAM
Listing No. 3774-1603:100

CRL EG100 Series Electronic Egress Control Handles are an economical method to control access into, and safe exit from, areas that call for security and still maintain the beauty and view of an 'all-glass' door. These elegant tubular devices give you maximum viewing area and a contemporary look when used on 1/2" or 3/4" (12 or 19 mm) tempered glass doors. Like our Panic and Deadbolt Handle Line, these Handles also meet the rigid requirements imposed by the A.D.A. Codes on every manufacturer and installer of 'all-glass' doors. The interior portion of the device is a slender 1-1/4" (32 mm) tube stretching across the door and then gently turning upwards to the top of the door. This eliminates any interference in the lower half of the door, which must remain clear of obstructions to pass A.D.A. demands.

An Electronic Switch is completely concealed within the tube and releases a Magnetic Lock at the top or bottom of the door when gently pushed. To complement the sleek interior look, we offer a variety of exterior pull handles that can be as simple as a horizontal handle (Model EG100A) to one that mirrors the interior device (Model EG100D). A Magnetic Lock must be ordered separately. Please contact CRL Technical Sales. For your convenience, Custom Headers are available with all lock hardware installed.

If A.D.A. Codes are not a concern, we also have our EG110 Series Electronic Egress Control Handles. These Handles are of the same sleek design and operation as the EG100 Series, except they stretch across the door and then bend downward to the bottom of the door. All of our EG100 and EG110 Electronic Egress Control Handles come equipped with surge suppression ZNR that is compatible with most Shear Locks. However, we suggest that the lock manufacturer be contacted to ensure compatibility with this feature. All CRL Electronic Egress Control Handles go through rigorous testing before they leave our manufacturing facility, ensuring that a high quality, dependable product is installed every time. Most importantly, they are all UL and ULC Recognized Components, tested to NFPA Life and Safety Code Standards. For more information on Electronic Egress Control Handles, please visit our web site at crlaurence.com.

MAXIMUM DOOR HEIGHTS:

- Exterior - 96" (2.44 m) for 1/2" (12 mm) Glass Thickness
- 102" (2.59 m) for 3/4" (19 mm) Glass Thickness
- Interior - 102" (2.59 m) for 1/2" (12 mm) Glass Thickness
- 108" (2.74 m) for 3/4" (19 mm) Glass Thickness
- Exception - When using "F" Style Exterior Handle
- 108" (2.74 m) for either 1/2" or 3/4" (12 or 19 mm) Glass Thickness

SPECIFICATIONS:

- Material:** 1-1/4" (32 mm) Diameter Brass or Stainless Steel Tubing (1.5 mm thick)
- Glass Thicknesses:** 1/2" (12 mm) or 3/4" (19 mm)
- Glass Fabrication:** Please contact CRL Technical Sales
- Certification:** UL294-2001 UL Recognized Component
ULC-S533-2002 ULC Recognized Component
NFPA 101-2002 Life and Safety Code



ELECTRONIC EGRESS EG100
Latches at top only



ELECTRONIC EGRESS EG110
Latches at bottom only



Contact CRL Technical Sales at (800) 421-6144 in the U.S., (877) 421-6144 from Canada, or (323) 588-1281 International, and ask for Ext. 7700. You can also send e-mail from the crlaurence.com home page. Click on Contact Us, and then click on Technical Sales for Commercial Products.

NOTE: All Access Control Handles on this page function as health and safety tools, and may only be purchased through CRL Authorized Glass Temperers and Door Manufacturers.

CRL Top Locking Electronic Egress Control Handle Details

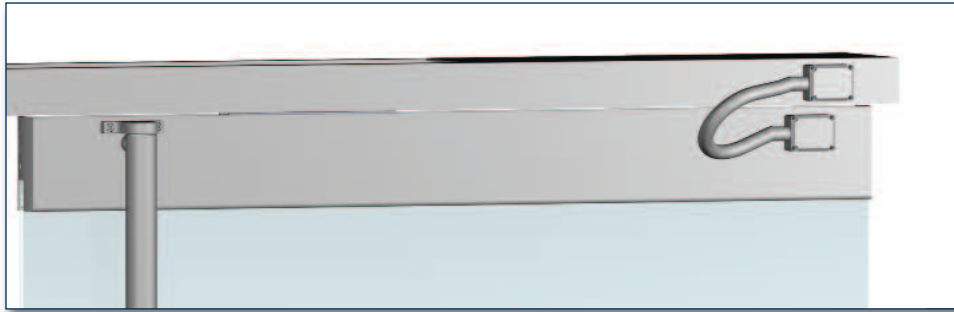

Rail Mount Detail at Header and Wire Loop for EG100



Keyed Access (With Removable Core)

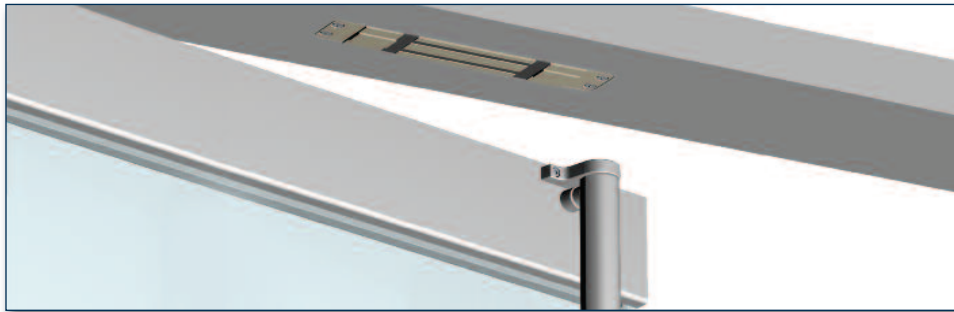

Rail Mount Detail at Top of EG100 With Header and SDC1562 Shear Lock

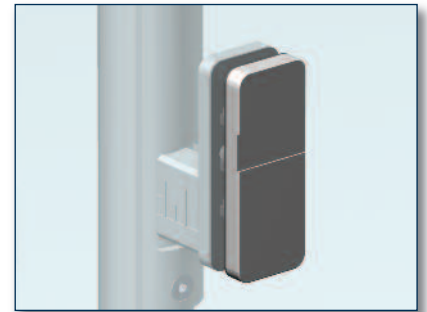

Retainer Plate

CRL Bottom Locking Electronic Egress Control Handle Details

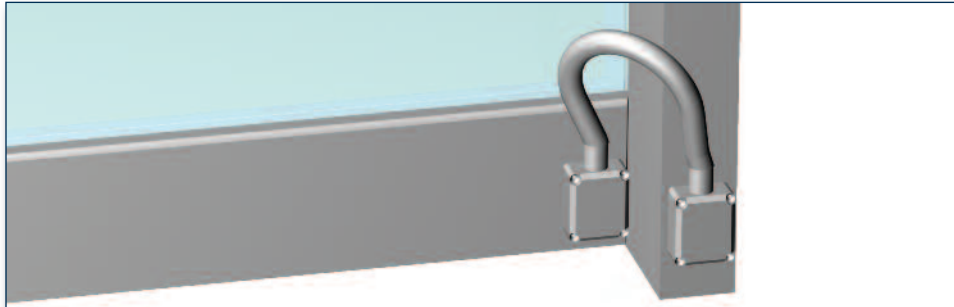

Rail Mount Detail at Sill/Jamb and Wire Loop for EG110



Keyed Access (With Removable Core)

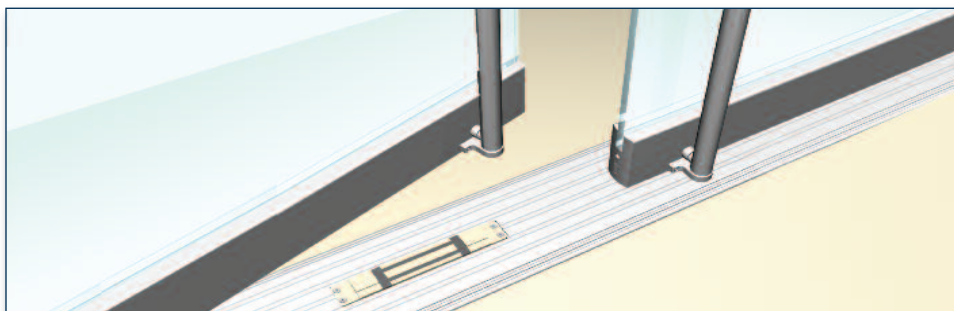

Rail Mount Detail at Bottom of EG110 With Threshold and SDC1562 Shear Lock

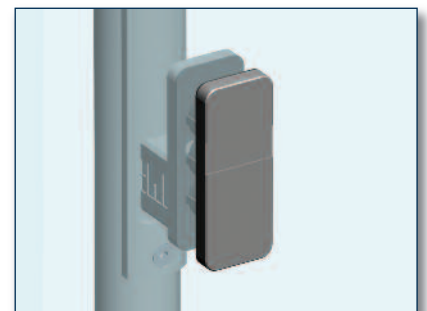

Retainer Plate

Contact CRL Technical Sales at (800) 421-6144 in the U.S., (877) 421-6144 from Canada, or (323) 588-1281 International, and ask for Ext. 7700. You can also send e-mail from the crlaurence.com home page. Click on Contact Us, and then click on Technical Sales for Commercial Products.

NOTE: All Access Control Handles on this page function as health and safety tools, and may only be purchased through CRL Authorized Glass Temperers and Door Manufacturers.

CRL Straight and Offset Back-to-Back Pull Handles

- Stocked in Up to Five Architectural Finishes
- For Use With 3/8" to 3/4" (10 to 19 mm) Glass
- Complete With Matching Finish Metal Washers and Through-Bolts for Mounting

SPECIFICATIONS:

For Use With: 3/8" to 3/4" (10 to 19 mm) Glass

Construction:

1" (25 mm) Diameter Stainless Steel or Brass Tubing.

*1-1/4" (32 mm) Diameter Stainless Steel (CD24X24BS125 model only).

Glass Fabrication Required:

Two 5/8" (16 mm) Diameter Holes,
 10x10: 10" (254 mm) Center-to-Center
 12x12: 12" (305 mm) Center-to-Center
 18x18: 18" (457 mm) Center-to-Center
 24x24: 24" (610 mm) Center-to-Center



Straight

Offset

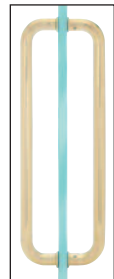

INCLUDES:

- 2 Each: Through-Bolts for Glass Mounting
- 4 Each: 1-1/4" (32 mm) Diameter Matching Finish Metal Washers and Rubber Gaskets



Extra bolts available, sold separately:

CAT. NO. DESCRIPTION

- TB2CH** Through-Bolts for 3/8" to 3/4" (10 to 19 mm) Glass
- TB4CH** Through-Bolts for 1-3/4" (45 mm) Wood or Metal Door Frames
- F40WK** Matching Washer Set and Through-Bolt for 3/8" to 3/4" (10 to 19 mm) Glass

STRAIGHT BACK-TO-BACK PULL HANDLES

CAT. NO.	SIZE	FINISH
CM10X10BS	10" (254 mm)	Brushed Stainless
CM10X10PS	10" (254 mm)	Polished Stainless
CM10X10BR	10" (254 mm)	Polished Brass
CM10X10SA	10" (254 mm)	Satin Anodized
CM10X10DU	10" (254 mm)	Dark Bronze Anodized
CM12X12BS	12" (305 mm)	Brushed Stainless
CM12X12PS	12" (305 mm)	Polished Stainless
CM12X12BR	12" (305 mm)	Polished Brass
CM12X12SA	12" (305 mm)	Satin Anodized
CM12X12DU	12" (305 mm)	Dark Bronze Anodized
CM18X18BS	18" (457 mm)	Brushed Stainless
CM18X18PS	18" (457 mm)	Polished Stainless
CM18X18BR	18" (457 mm)	Polished Brass
CM24X24BS	24" (610 mm)	Brushed Stainless
CM24X24PS	24" (610 mm)	Polished Stainless
CM24X24BR	24" (610 mm)	Polished Brass

Minimum order: 1 each. All Pull Handles can be combined for quantity pricing.

OFFSET BACK-TO-BACK PULL HANDLES

CAT. NO.	SIZE	FINISH
CD10X10BS	10" (254 mm)	Brushed Stainless
CD10X10PS	10" (254 mm)	Polished Stainless
CD10X10BR	10" (254 mm)	Polished Brass
CD10X10SA	10" (254 mm)	Satin Anodized
CD10X10DU	10" (254 mm)	Dark Bronze Anodized
CD12X12BS	12" (305 mm)	Brushed Stainless
CD12X12PS	12" (305 mm)	Polished Stainless
CD12X12BR	12" (305 mm)	Polished Brass
CD12X12SA	12" (305 mm)	Satin Anodized
CD12X12DU	12" (305 mm)	Dark Bronze Anodized
CD18X18BS	18" (457 mm)	Brushed Stainless
CD18X18PS	18" (457 mm)	Polished Stainless
CD18X18BR	18" (457 mm)	Polished Brass
CD24X24BS125*	24" (610 mm)	Brushed Stainless

Minimum order: 1 each. All Pull Handles can be combined for quantity pricing.

CRL Glass Mounted Solid Back-to-Back Pull Handle

SPECIFICATIONS:

For Use With:

3/8" to 3/4" (10 to 19 mm) Glass

Construction:

1" (25 mm) Solid Stainless Steel or Brass

Glass Fabrication Required:

Two 5/8" (16 mm) Diameter Holes,
 10x10: 10" (254 mm) Center-to-Center;
 12x12: 12" (305 mm) Center-to-Center

INCLUDES:

- 2 Each: Through-Bolts for Glass Mounting
- 4 Each: 1-1/4" (32 mm) Diameter Matching Finish Metal Washers and Rubber Gaskets



new

CAT. NO.	SIZE	FINISH
CS10X10BS	10" (254 mm)	Brushed Stainless
CS10X10PS	10" (254 mm)	Polished Stainless
CS10X10BR	10" (254 mm)	Polished Brass
CS12X12BS	12" (305 mm)	Brushed Stainless
CS12X12PS	12" (305 mm)	Polished Stainless
CS12X12BR	12" (305 mm)	Polished Brass

Minimum order: 1 each. All Pull Handles can be combined for quantity pricing.

CRL Glass Mounted Mitered Corner Style Back-to-Back Pull Handle

SPECIFICATIONS:

For Use With:

3/8" to 3/4" (10 to 19 mm) Glass

Construction:

1" (25 mm) Round Stainless Steel Tubing

Glass Fabrication Required:

Two 5/8" (16 mm) Diameter Holes,
 10x10: 10" (254 mm) Center-to-Center
 12x12: 12" (305 mm) Center-to-Center
 18x18: 18" (457 mm) Center-to-Center
 24x24: 24" (610 mm) Center-to-Center

INCLUDES:

- 2 Each: Through-Bolts for Glass Mounting
- 4 Each: 1-1/4" (32 mm) Diameter Matching Finish Metal Washers and Rubber Gaskets



new

CAT. NO.	SIZE	FINISH
MH10X10BS	10" (254 mm)	Brushed Stainless
MH10X10PS	10" (254 mm)	Polished Stainless
MH12X12BS	12" (305 mm)	Brushed Stainless
MH12X12PS	12" (305 mm)	Polished Stainless
MH18X18BS	18" (457 mm)	Brushed Stainless
MH18X18PS	18" (457 mm)	Polished Stainless
MH24X24BS	24" (610 mm)	Brushed Stainless
MH24X24PS	24" (610 mm)	Polished Stainless

Minimum order: 1 each. All Pull Handles can be combined for quantity pricing. Optional 1-1/4" (32 mm) diameter available on special order.

Extra bolts available, sold separately:

CAT. NO. DESCRIPTION

- TB2CH** Through-Bolts 3/8" to 3/4" (10 to 19 mm) Glass
- TB4CH** Through-Bolts for 1-3/4" (45 mm) Wood or Metal Door Frames
- F40WK** Matching Washer Set and Through-Bolt for 3/8" to 3/4" (10 to 19 mm) Glass

CRL Glass Mounted Square Tube Style Back-to-Back Pull Handle

new



SPECIFICATIONS:

For Use With: 3/8" to 3/4" (10 to 19 mm) Glass

Construction: 1" (25 mm) Square Stainless Steel Tubing

Glass Fabrication Required:

Two 5/8" (16 mm) Diameter Holes,
10x10: 10" (254 mm) Center-to-Center
12x12: 12" (305 mm) Center-to-Center
18x18: 18" (457 mm) Center-to-Center
24x24: 24" (610 mm) Center-to-Center

INCLUDES:

2 Each: Through-Bolts for Glass Mounting

CAT. NO.	SIZE	FINISH
SQ10X10BS	10" (254 mm)	Brushed Stainless
SQ10X10PS	10" (254 mm)	Polished Stainless
SQ12X12BS	12" (305 mm)	Brushed Stainless
SQ12X12PS	12" (305 mm)	Polished Stainless
SQ18X18BS	18" (457 mm)	Brushed Stainless
SQ18X18PS	18" (457 mm)	Polished Stainless
SQ24X24BS	24" (610 mm)	Brushed Stainless
SQ24X24PS	24" (610 mm)	Polished Stainless

Minimum order: 1 each. All Pull Handles can be combined for quantity pricing.

Extra bolts available, sold separately:

CAT. NO.	DESCRIPTION
TB2CH	Through-Bolts for 3/8" to 3/4" (10 to 19 mm) Glass
TB4CH	Through-Bolts for 1-3/4" (45 mm) Wood or Metal Door Frames

CRL Glass Mounted Rounded Corner Square Tube Style Back-to-Back Pull Handle

new



SPECIFICATIONS:

For Use With: 3/8" to 3/4" (10 to 19 mm) Glass

Construction: 1" (25 mm) Square Stainless Steel Tubing

Glass Fabrication Required:

Two 5/8" (16 mm) Diameter Holes,
10x10: 10" (254 mm) Center-to-Center
12x12: 12" (305 mm) Center-to-Center
18x18: 18" (457 mm) Center-to-Center
24x24: 24" (610 mm) Center-to-Center

INCLUDES:

2 Each: Through-Bolts for Glass Mounting

CAT. NO.	SIZE	FINISH
RST10X10BS	10" (254 mm)	Brushed Stainless
RST10X10PS	10" (254 mm)	Polished Stainless
RST12X12BS	12" (305 mm)	Brushed Stainless
RST12X12PS	12" (305 mm)	Polished Stainless
RST18X18BS	18" (457 mm)	Brushed Stainless
RST18X18PS	18" (457 mm)	Polished Stainless
RST24X24BS	24" (610 mm)	Brushed Stainless
RST24X24PS	24" (610 mm)	Polished Stainless

Minimum order: 1 each. All Pull Handles can be combined for quantity pricing.

Extra bolts available, sold separately:

CAT. NO.	DESCRIPTION
TB2CH	Through-Bolts for 3/8" to 3/4" (10 to 19 mm) Glass
TB4CH	Through-Bolts for 1-3/4" (45 mm) Wood or Metal Door Frames

CRL Glass Mounted Straight and Offset Combination Push and Pull Handles

- Five Beautiful Architectural Finishes
- For Use With 3/8" to 3/4" (10 to 19 mm) Glass



SPECIFICATIONS:

For Use With:

3/8" to 3/4" (10 to 19 mm) Glass

Construction:

1" (25 mm) Diameter
Stainless Steel or Brass Tubing

Glass Fabrication Required:

Three 5/8" (16 mm) Diameter Holes,
10" (254 mm) Center-to-Center
12" (305 mm) Center-to-Center
28" (711 mm) Center-to-Center
33" (838 mm) Center-to-Center

Optional 1-1/4" (32 mm) Diameter Available on Special Order

INCLUDES:

2 Each:
Through-Bolts for Glass Mounting
4 Each:
1-1/4" (32 mm) Diameter Matching Finish Metal Washers and Rubber Gaskets

Extra bolts available, sold separately:

CAT. NO.	DESCRIPTION
TB2CH	Through-Bolts for 3/8" to 3/4" (10 to 19 mm) Glass
TB4CH	Through-Bolts for 1-3/4" (45 mm) Wood or Metal Door Frames
F40WK	Matching Washer Set and Through-Bolt for 3/8" to 3/4" (10 to 19 mm) Glass
F40SK	Matching Washer and Stud Kit for Single-Sided Attachment for 3/8" to 3/4" (10 to 19 mm) Glass

STRAIGHT COMBINATION PUSH AND PULL HANDLES

CAT. NO.	SIZE	FINISH
CM10X28BS	10" X 28"	Brushed Stainless
CM10X28PS	10" X 28"	Polished Stainless
CM10X28BR	10" X 28"	Polished Brass
CM10X28SA	10" X 28"	Satin Anodized
CM10X28DU	10" X 28"	Dark Bronze Anodized
CM12X28BS	12" X 28"	Brushed Stainless
CM12X28PS	12" X 28"	Polished Stainless
CM12X28BR	12" X 28"	Polished Brass
CM12X28SA	12" X 28"	Satin Anodized
CM12X28DU	12" X 28"	Dark Bronze Anodized

Minimum order: 1 each. All Pull Handles can be combined for quantity pricing.

OFFSET COMBINATION PUSH AND PULL HANDLES

CAT. NO.	SIZE	FINISH
CD10X28BS	10" X 28"	Brushed Stainless
CD10X28PS	10" X 28"	Polished Stainless
CD10X28BR	10" X 28"	Polished Brass
CD10X28SA	10" X 28"	Satin Anodized
CD10X28DU	10" X 28"	Dark Bronze Anodized
CD10X33BS	10" X 33"	Brushed Stainless
CD10X33PS	10" X 33"	Polished Stainless
CD10X33BR	10" X 33"	Polished Brass
CD10X33SA	10" X 33"	Satin Anodized
CD10X33DU	10" X 33"	Dark Bronze Anodized
CD12X28BS	12" X 28"	Brushed Stainless
CD12X28PS	12" X 28"	Polished Stainless
CD12X28BR	12" X 28"	Polished Brass
CD12X28SA	12" X 28"	Satin Anodized
CD12X28DU	12" X 28"	Dark Bronze Anodized

Minimum order: 1 each. All Pull Handles can be combined for quantity pricing.

CRL Glass Mounted Curved Style Back-to-Back Pull Handle

SPECIFICATIONS:

For Use With:

3/8" to 3/4" (10 to 19 mm) Glass

Construction:

1" (25 mm) Diameter Stainless Steel or Brass Tubing

Glass Fabrication Required:

Two 5/8" (16 mm) Diameter Holes,
12" (305 mm) Center-to-Center



INCLUDES:

- 2 Each: Through-Bolts for Glass Mounting
- 4 Each: 1-1/4" (32 mm) Diameter Matching Finish Metal Washers and Rubber Gaskets

Extra bolts available, sold separately:

CAT. NO. DESCRIPTION

- TB2CH** Through-Bolts for 3/8" to 3/4" (10 to 19 mm) Glass
- TB4CH** Through-Bolts for 1-3/4" (45 mm) Wood or Metal Door Frames
- F40WK** Matching Washer Set and Through-Bolt for 3/8" to 3/4" (10 to 19 mm) Glass

CAT. NO.	FINISH
CC12X12BS	Brushed Stainless
CC12X12PS	Polished Stainless
CC12X12BR	Polished Brass
CC12X12DU	Dark Bronze Anodized

Minimum order: 1 each. All Pull Handles can be combined for quantity pricing.

CRL Glass Mounted Elbow Style Back-to-Back Pull Handle

SPECIFICATIONS:

For Use With:

3/8" to 3/4" (10 to 19 mm) Glass

Construction:

1" (25 mm) Diameter Stainless Steel or Brass Tubing

Glass Fabrication Required:

Two 5/8" (16 mm) Diameter Holes,
12" (305 mm) Center-to-Center



INCLUDES:

- 2 Each: Through-Bolts for Glass Mounting
- 4 Each: 1-1/4" (32 mm) Diameter Matching Finish Metal Washers and Rubber Gaskets

Extra bolts available, sold separately:

CAT. NO. DESCRIPTION

- TB2CH** Through-Bolts for 3/8" to 3/4" (10 to 19 mm) Glass
- TB4CH** Through-Bolts for 1-3/4" (45 mm) Wood or Metal Door Frames
- F40WK** Matching Washer Set and Through-Bolt for 3/8" to 3/4" (10 to 19 mm) Glass

CAT. NO.	FINISH
CV12X12BS	Brushed Stainless
CV12X12PS	Polished Stainless
CV12X12BR	Polished Brass

Minimum order: 1 each. All Pull Handles can be combined for quantity pricing.

CRL Glass Mounted Bracket Style Back-to-Back Pull Handle

SPECIFICATIONS:

For Use With:

3/8" to 3/4" (10 to 19 mm) Glass

Construction:

1" (25 mm) Diameter Stainless Steel Tubing

Glass Fabrication Required:

Two 5/8" (16 mm) Diameter Holes,
16-3/4" (425 mm) Center-to-Center

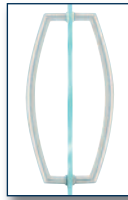

INCLUDES:

- 2 Each: Through-Bolts for Glass Mounting
- 4 Each: 1-1/4" (32 mm) Diameter Matching Finish Metal Washers and Rubber Gaskets

CAT. NO.	FINISH
CX17X17BS	Brushed Stainless
CX17X17PS	Polished Stainless

Minimum order: 1 each. All Pull Handles can be combined for quantity pricing.

CRL Glass Mounted Sculptured Style Back-to-Back Pull Handle

SPECIFICATIONS:

For Use With:

3/8" and 1/2" (10 and 12 mm) Glass

Construction:

Cast Solid Brass

Glass Fabrication Required:

Two 5/8" (16 mm) Diameter Holes,
10" (254 mm) Center-to-Center

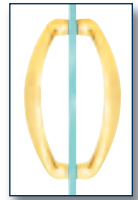

INCLUDES:

- 2 Each: Through-Bolts for Glass Mounting
- 4 Each: 1-1/16" (27 mm) Diameter Matching Finish Metal Washers and Rubber Gaskets

CAT. NO.	FINISH
CQ10X10CH	Chrome Plated
CQ10X10BR	Polished Brass
CQ10X10BSC	Brushed Satin Chrome
CQ10X10BN	Brushed Nickel
CQ10X10PN	Polished Nickel
CQ10X10ABR	Antique Brass
CQ10X10GP	Gold Plated
CQ10X10ORB	Oil Rubbed Bronze

Minimum order: 1 each. All Pull Handles can be combined for quantity pricing.

CRL Glass Mounted Ladder Style Back-to-Back Pull Handle With Acrylic Semi-Inserts



SPECIFICATIONS:

For Use With:

3/8" to 3/4" (10 to 19 mm) Glass

Construction:

1" (25 mm) Diameter Stainless Steel or Brass Tubing with Acrylic Semi-Insert (White Accent Lines in Acrylic)

Glass Fabrication Required:

Two 5/8" (16 mm) Diameter Holes, 18" (457 mm) Center-to-Center

Overall Length:

24-1/2" (622 mm)

INCLUDES:

2 Each: Through-Bolts for Glass Mounting

4 Each: 1-1/4" (32 mm) Diameter Matching Finish Metal Washers and Rubber Gaskets

CAT. NO.	FINISH
CA18X18BR	Polished Brass
CA18X18PS	Polished Stainless

Minimum order: 1 each. All Pull Handles can be combined for quantity pricing.



CRL Glass Mounted Ladder Style Back-to-Back Pull Handle With Acrylic Full Inserts

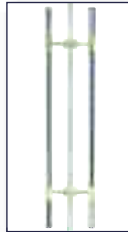

SPECIFICATIONS:

For Use With:

3/8" to 3/4" (10 to 19 mm) Glass

Construction:

1" (25 mm) Diameter Stainless Steel or Brass Tubing with Acrylic Full Insert (Accent Lines in Acrylic)

Glass Fabrication Required:

Two 5/8" (16 mm) Diameter Holes, 18" (457 mm) Center-to-Center

Overall Length:

27" (685 mm)

INCLUDES:

2 Each: Through-Bolts for Glass Mounting

4 Each: 1-1/4" (32 mm) Diameter Matching Metal Finish Washers and Rubber Gaskets

CAT. NO.	FINISH
CB18X18BR	Polished Brass
CB18X18PS	Polished Stainless

Minimum order: 1 each. All Pull Handles can be combined for quantity pricing.



CRL Glass Mounted Ring Style Back-to-Back Pull Handle

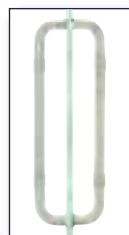

SPECIFICATIONS:

For Use With:

3/8" to 3/4" (10 to 19 mm) Glass

Construction:

1" (25 mm) Diameter Stainless Steel or Brass Tubing

Glass Fabrication Required:

Two 5/8" (16 mm) Diameter Holes, 18" (457 mm) Center-to-Center

Overall Length:

19" (483 mm)

INCLUDES:

2 Each: Through-Bolts for Glass Mounting

4 Each: 1-1/4" (32 mm) Diameter Matching Finish Metal Washers and Rubber Gaskets

CAT. NO.	FINISH
CR18X18BR	Polished Brass
CR18X18PS	Polished Stainless

Minimum order: 1 each. All Pull Handles can be combined for quantity pricing.



CRL Glass Mounted Ladder Style Back-to-Back Pull Handle With Undercut Accent Rings

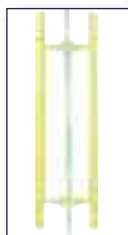

SPECIFICATIONS:

For Use With:

3/8" to 3/4" (10 to 19 mm) Glass

Construction:

1" (25 mm) Diameter Stainless Steel or Brass Tubing

Glass Fabrication Required:

Two 5/8" (16 mm) Diameter Holes, 18" (457 mm) Center-to-Center

Overall Length:

25" (635 mm)

INCLUDES:

2 Each: Through-Bolts for Glass Mounting

4 Each: 1-1/4" (32 mm) Diameter Matching Finish Metal Washers and Rubber Gaskets

CAT. NO.	FINISH
CT18X18BR	Polished Brass
CT18X18PS	Polished Stainless
CT18X18BS	Brushed Stainless

Minimum order: 1 each. All Pull Handles can be combined for quantity pricing.

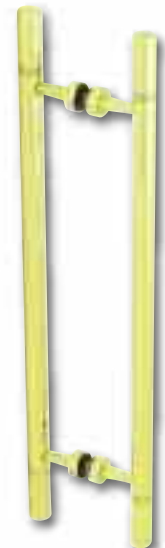

CRL Variant Series Adjustable Mounting Post Style Pull Handles

- Adjustable Mounting Posts Can Mount on 6" to 26-3/4" (152 to 679 mm) Centers

CRL Variant Series Adjustable Mounting Post Style Pulls are designed to fit on standard hole patterns of 12", 18", and 24" (305, 457, and 610 mm) centers, but with its adjustable mounting posts will fit almost any hole pattern from 6" to 26-3/4" (152 to 679 mm) centers. Additional Mounting Posts can also be purchased separately.

SPECIFICATIONS:

For Use With:

3/8" to 3/4" (10 to 19 mm) Glass

Construction:

1" (25 mm) Diameter Stainless Steel Tubing

Glass Fabrication Required:

Two 5/8" (16 mm) Diameter Holes,

VPS x 16: 12" (305 mm) Center-to-Center

VPS x 22: 18" (457 mm) Center-to-Center

VPS x 28: 24" (610 mm) Center-to-Center

NOTE: Hole centers shown are for standard mounting locations. You may vary actual hole centers.

INCLUDES:

2 Each: Through-Bolts for Glass Mounting

4 Each: Adjustable Mounting Posts
(VP1 or VP2 Depending on Handle Style)



Pull Set With VP1 Mounting Posts

Pull Set With VP2 Mounting Posts

VARIANT PULL SET WITH VP1 MOUNTING POSTS

CAT. NO.	ROD LENGTH	FINISH
VPS116BS	16" (406 mm)	Brushed Stainless
VPS116PS	16" (406 mm)	Polished Stainless
VPS122BS	22" (559 mm)	Brushed Stainless
VPS122PS	22" (559 mm)	Polished Stainless
VPS128BS	28" (711 mm)	Brushed Stainless
VPS128PS	28" (711 mm)	Polished Stainless

VARIANT PULL SET WITH VP2 MOUNTING POSTS

CAT. NO.	ROD LENGTH	FINISH
VPS216BS	16" (406 mm)	Brushed Stainless
VPS216PS	16" (406 mm)	Polished Stainless
VPS222BS	22" (559 mm)	Brushed Stainless
VPS222PS	22" (559 mm)	Polished Stainless
VPS228BS	28" (711 mm)	Brushed Stainless
VPS228PS	28" (711 mm)	Polished Stainless

ADDITIONAL MOUNTING POSTS

CAT. NO.	TYPE	FINISH
VP1BS	VP1	Brushed Stainless
VP1PS	VP1	Polished Stainless
VP2BS	VP2	Brushed Stainless
VP2PS	VP2	Polished Stainless

Minimum order: 1 set. Each set includes: 2 each Through-Bolts for Glass Mounting; 4 each Adjustable Mounting Posts

Minimum order: 1 each. All Pull Handles can be combined for quantity pricing.

Minimum order: 1 each. All Pull Handles can be combined for quantity pricing.

CRL Frameless Sliding Door Handle

- Four Architectural Finishes Available for 1/2" (12 mm) Glass
- Low Projection Will Not Interfere With Sliding Door Action

CRL Frameless Sliding Door Handles feature a low profile projection that will not interfere with the sliding action of the door passing another panel or even a pocket type installation into the wall. These Handles are available in four stock architectural finishes to complement our Frameless Sliding Door Systems. Custom finishes and custom sizes are also available upon request.

Glass Fabrication Required: Glass Cut-Out With Polished Edges; Two 1/2" (13 mm) Diameter Holes

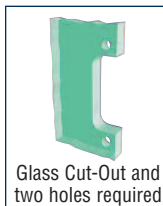

Glass Cut-Out and two holes required

CAT. NO.	FINISH
SGH8CH	Chrome
SGH8BR	Lacquered Brass Brushed
SGH8BN	Nickel
SGH8SC	Satin Chrome

Minimum order: 1 each. Finishes can be combined for quantity pricing.



CRL Extruded Aluminum Pull Handle

- Solid Extruded Aluminum Handle Mounts to Door With Concealed Fasteners
- Two Finishes Available

The Extruded Aluminum Pull Handle comes with two studs that are tapped (1/4-20 thread) into the aluminum door frame on 10" (254 mm) centers. Then the Handle is slipped over the studs and secured with Allen screws to provide a concealed fastener look. Available in choice of satin anodized and dark bronze finishes. One per package.

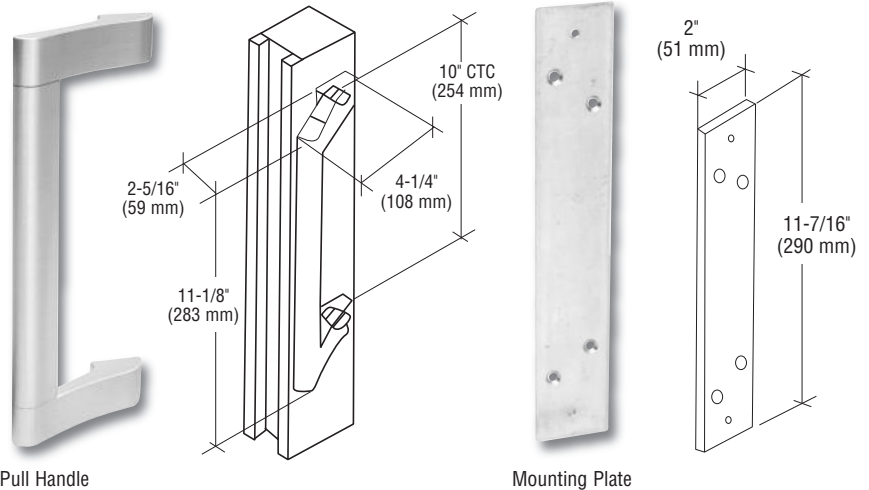

Pull Handle

Mounting Plate

DL915 EXTRUDED ALUMINUM PULL HANDLE

CAT. NO.	DESCRIPTION	FINISH
DL915A	Pull Handle	Satin Anodized
DL915DU	Pull Handle	Dark Bronze Anodized

Minimum order: 1 each. Finishes can be combined for quantity pricing.

DL916 OPTIONAL MOUNTING PLATE

CAT. NO.	DESCRIPTION	FINISH
DL916A	Mounting Plate	Satin Anodized
DL916DU	Mounting Plate	Dark Bronze Anodized

Minimum order: 1 each. Finishes can be combined for quantity pricing.

CRL Tapered Door Pull

- Solid Pull has Clear Anodized Brushed Aluminum Finish
- Complete With Through-Bolts for Mounting

This Tapered Door Pull is made from solid aluminum bar stock, tapered on each end, and has a projection height of 1-1/2" (38 mm) from the face of the door. Brushed aluminum finish is clear anodized. Complete with through-bolts for mounting. Minimum order is one each.

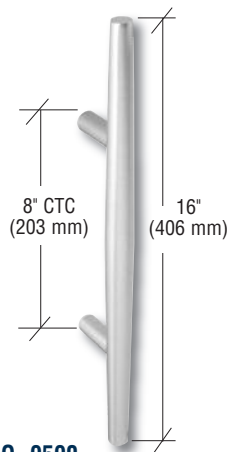

CAT. NO. 9590

CRL Entrance Door Pull

- Solid Pull has Clear Anodized Brushed Aluminum Finish
- Complete With Through-Bolts for Mounting

This solid aluminum Entrance Door Pull has a black accent strip along the full length of the pull. Projection height is 2-7/8" (73 mm) from the face of the door. Brushed aluminum finish is clear anodized. Complete with through-bolts for mounting. Minimum order is one each.

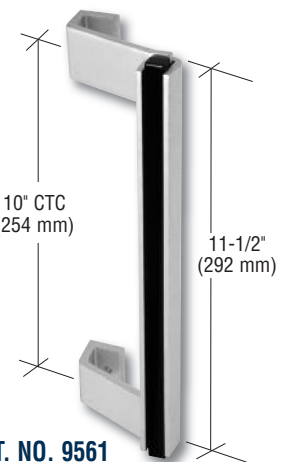

CAT. NO. 9561

CRL Solid Offset Back-to-Back Pull Handle for Aluminum Doors

- Two Finishes Available

This set of 1" (25 mm) extruded aluminum Offset Door Pulls comes in your choice of satin anodized or dark bronze finishes.

Dimensions: 10" (254 mm) center-to-center mounting holes; 2-1/4" (57 mm) clearance; 3-1/4" (83 mm) projection.

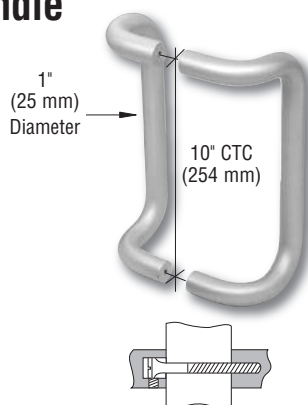

Mounting

Threaded Shoulder Bolt and Set Screw

CAT. NO.	FINISH
2952PRA	Satin Anodized
2952PRBRZ	Dark Bronze Anodized

Minimum order: 1 pair. All Pull Handles can be combined for quantity pricing.

CRL Solid Offset Single-Sided Pull Handle for Aluminum Doors

- Two Finishes Available

Extra sturdy 1" (25 mm) extruded aluminum Offset Door Pull in your choice of satin anodized or dark bronze finishes.

Dimensions: 10" (254 mm) center-to-center mounting holes; 2-1/4" (57 mm) clearance; 3-1/4" (83 mm) projection.

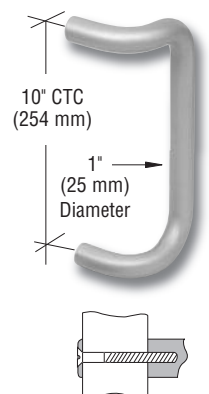

Mounting

Through-Bolt and Finish Washer

CAT. NO.	FINISH
2952A	Satin Anodized
2952BRZ	Dark Bronze Anodized

Minimum order: 1 each. All Pull Handles can be combined for quantity pricing.

CRL Solid Aluminum Push Bar and Pull Set

- **Two Finishes Available to Fit 36" (914 mm) Narrow Stile Doors**

1" (25 mm) extruded aluminum Push and Pull Set in your choice of dark bronze or satin anodized finish.

Dimensions: 10" (254 mm) center-to-center mounting holes for Offset Pulls, 33" (838 mm) for Push Bars; 3-1/4" pull projection; 2-1/4" (57 mm) bar projection; length to fit 36" (914 mm) narrow stile doors.

CAT. NO.	FINISH
2958A	Satin Anodized
2958BRZ	Dark Bronze Anodized

Minimum order: 1 each. All Door Handles can be combined for quantity pricing.

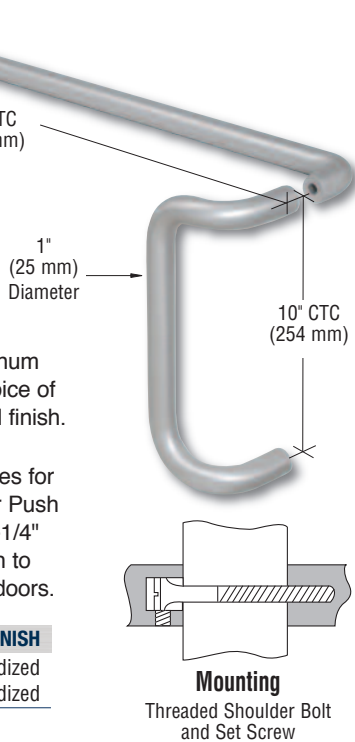

CRL Tubular Offset Single-Sided Pull Handle

- **Available in Five Architectural Finishes**
- **Ready to Mount**

Constructed of 1" (25 mm) stainless steel or brass tubing with 1-1/4" (32 mm) diameter matching backing washers. Choice of five architectural finishes to complement any décor.

Dimensions: 10" (254 mm) center-to-center mounting holes; 2" (51 mm) clearance; 3-1/4" (83 mm) projection.

CAT. NO.	FINISH
CD10BS	Brushed Stainless
CD10PS	Polished Stainless
CD10BR	Polished Brass
CD10SA	Satin Anodized
CD10DU	Dark Bronze Anodized

Minimum order: 1 each. All Door Handles can be combined for quantity pricing.

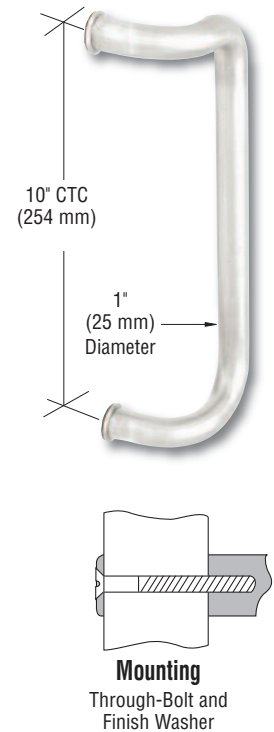

CRL Custom Designed Door Handles

- **For Glass, Wood, or Aluminum Doors**
- **"Cutting Edge" Laser and Waterjet Capabilities**
- **Round, Square or Flat Bar Stock**
- **Solid or Tubular Construction**
- **Custom Cast Designs**
- **Metal Etched Logos and Designs**
- **Bending, Mitering, and Welding**
- **Unlimited CNC Machined Shapes**
- **Wide Range of Fastening Options Including UV Bonding**
- **Available in Brass, Bronze, Aluminum, and Stainless Steel**
- **Brushed, Polished, Etched, or Powder Coated Finishes**
- **Over 20 Standard Finishes**
- **Custom Color Matching Available**



Imagination

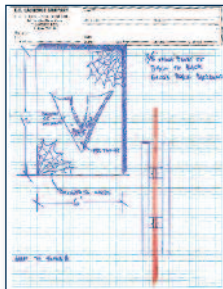

Design

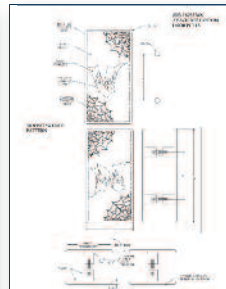

Reality



Let CRL make your idea a reality! Send us your specifications and our Technical Sales Staff will design your custom handles for you. Then our engineering staff will supply you with a 3D rendered drawing of your design to ensure we make exactly what you want.

For additional information, or to begin the design process, contact CRL Technical Sales at (800) 421-6144 in the U.S., (877) 421-6144 from Canada, or (323) 588-1281 International. Ask for Ext. 7700. You can also e-mail us through our web site at crlaurence.com. From the home page click on Contact Us, and then click on Technical Sales for Commercial Products.



CRL Universal Push-Pull Paddles

- Field Reversible for Left or Right Hand Installations
- Fits CRL DL2140 Series, Adams Rite, S.Parker, I.D.C., Global and Primeline Deadlatches
- Available in Up to Six Finishes

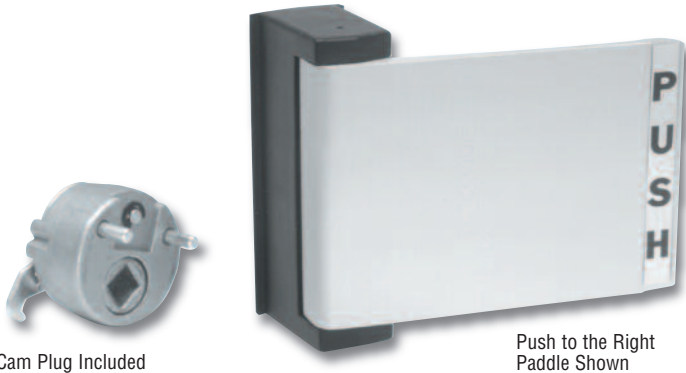

Cam Plug Included

Push to the Right Paddle Shown

The Universal Push-Pull Paddle comes with cartridges which allow it to be applied to push or pull, left or right handed doors. It fits deadlatches with backsets from 7/8" (22 mm) to 1-1/2" (38 mm). Simple to follow instructions allow field reversal to meet your needs. Comes complete with cam plug, push and pull indicators, mounting screws, templates, and directions. Measures approximately 5" x 4" (127 x 102 mm). Buying the paddle to meet your specifications from the chart below eliminates disassembling and reassembling internal parts. One per package.

OPERATION	
	DL2161 Series
	DL2162 Series
	DL2163 Series
	DL2164 Series

CAT. NO.	OPERATION	FINISH
DL2161A	Pull Left/Push Right	Aluminum
DL2161DU	Pull Left/Push Right	Bronze
DL2161BR	Pull Left/Push Right	Brass
DL2161CH	Pull Left/Push Right	Chrome
DL2161BN	Pull Left/Push Right	Brushed Nickel
DL2161SC	Pull Left/Push Right	Satin Chrome
DL2162A	Push Left/Pull Right	Aluminum
DL2162DU	Push Left/Pull Right	Bronze
DL2162BR	Push Left/Pull Right	Brass
DL2162CH	Push Left/Pull Right	Chrome
DL2162BN	Push Left/Pull Right	Brushed Nickel
DL2162SC	Push Left/Pull Right	Satin Chrome
DL2163A	Pull Right/Push Left	Aluminum
DL2163DU	Pull Right/Push Left	Bronze
DL2164A	Push Right/Pull Left	Aluminum
DL2164DU	Push Right/Pull Left	Bronze

Minimum order: 1 each. All Paddles and Lever Handles can be combined for quantity pricing.

CRL Cam Plug

- For Use With Push-Pull and Lever Handles
- Non-Handed, Reversible

The Cam Plug works with DL2160 Series Paddles and DL2150 Series Lever Handles. Interfaces with all CRL Deadlatches. One per package. Minimum order is one each.

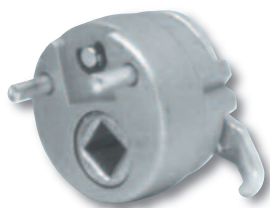

CAT. NO. DL2165

CRL Lever Handles

- Field Reversible for Left or Right Hand Installations
- Fits CRL DL2140 Series, Adams Rite, S. Parker, I.D.C., Global and Primeline Deadlatches
- Available in Six Finishes

Turning lever downward will activate deadlatch. Heavy-duty spring will return the lever automatically to fully horizontal position. The escutcheon is 1-3/8" x 4" (35 x 102 mm), with a 1/4" (6.3 mm) square hardened spindle that interlocks in the cam plug. One per package.



Cam Plug Included

CAT. NO.	HANDING	FINISH
DL2150LHA	Left	Aluminum
DL2150LHBN	Left	Brushed Nickel
DL2150LHBR	Left	Brass
DL2150LHCH	Left	Chrome
DL2150LHCU	Left	Bronze
DL2150LHSC	Left	Satin Chrome
DL2150RHA	Right	Aluminum
DL2150RHBN	Right	Brushed Nickel
DL2150RHBR	Right	Brass
DL2150RHCH	Right	Chrome
DL2150RHCU	Right	Bronze
DL2150RHSC	Right	Satin Chrome

Minimum order: 1 each. All Paddles and Lever Handles can be combined for quantity pricing.

CRL A.D.A. Door Rail Adaptor

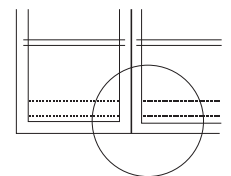
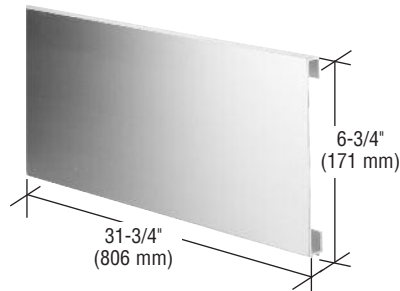

Allows existing doors to meet California Title 24 Handicap Code requirements of a 10" (254 mm) bottom rail. Easily mounts between door stiles with double face tape. 6-3/4" (171 mm) wide x 31-3/4" (806 mm) long to fit 36" (914 mm) doors. Other sizes are available on special order. One per package.



CAT. NO.	FINISH
10AD	Aluminum
10BRZ	Bronze

Minimum order: 1 each.

CRL Door Kick Plate

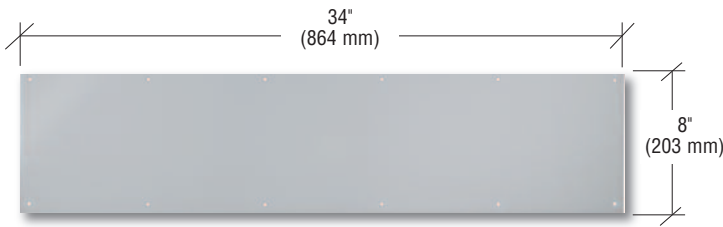

- Now in Three Architectural Finishes
- Protects Door Surfaces

Door Kick Plates are used to protect 36" (914 mm) wide door bottoms from scuffing. Comes with pre-drilled mounting holes and all hardware needed to fasten to the door. 3/64" (1.2 mm) thick Plates come one per package.

CAT. NO.	FINISH
37	Satin Aluminum
37SS	Brushed Stainless
37PB	Polished Brass

Minimum order: 1 each. All Kick Plates and Push/ Pull Plates can be combined for quantity pricing.

CRL Push Plate

- Protect Door Surfaces
- Now in Three Architectural Finishes

Push Plates eliminate hand prints and scratch marks to the door face. Comes with pre-drilled mounting holes and all hardware needed to fasten to the door. 3/64" (1.2 mm) thick Plates come one per package.

CAT. NO.	FINISH
47	Satin Aluminum
47SS	Brushed Stainless
47PB	Polished Brass

Minimum order: 1 each. All Kick Plates and Push/ Pull Plates can be combined for quantity pricing.

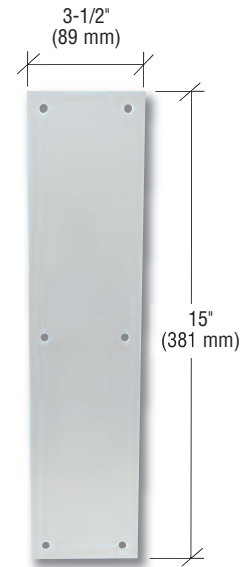

CRL Contoured Handle Pull Plate

- Now in Three Architectural Finishes
- Heavy Die Cast Handle

This CRL Pull Plate is 3/64" (1.2 mm) thick with a heavy die cast contoured pull handle. It has beveled edges with pre-drilled mounting holes. All mounting hardware is included. One per package.

CAT. NO.	FINISH
57N	Satin Aluminum
57SS	Brushed Stainless
57PB	Polished Brass

Minimum order: 1 each. All Kick Plates and Push/ Pull Plates can be combined for quantity pricing.

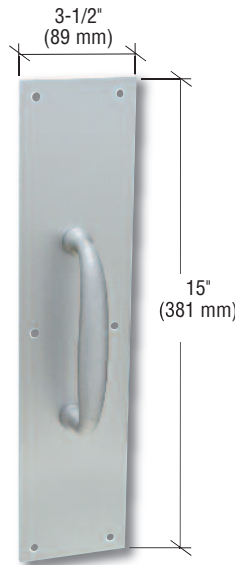

CRL Round Handle Pull Plate

- Now in Three Architectural Finishes
- Solid Round Pull Handle

The CRL Round Handle Pull Plate is 3/64" (1.2 mm) thick, with a 3/4" (19 mm) diameter solid round pull handle. All mounting hardware is included. One per package.

CAT. NO.	FINISH
67N	Satin Aluminum
67SS	Brushed Stainless
67PB	Polished Brass

Minimum order: 1 each. All Kick Plates and Push/ Pull Plates can be combined for quantity pricing.

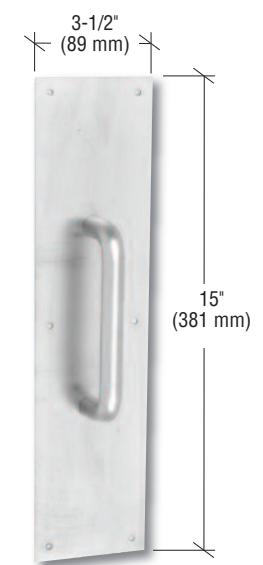

CRL Extruded Aluminum Push Bars

- Available in Three Lengths and Two Finishes



Extruded Aluminum Push Bars come with a "J" Hook on one end. The opposite end needs to be drilled at time of installation to match application. Bar measures 1/2" x 1-1/4" (12 x 32 mm). One per package.

CAT. NO.	FITS UP TO:	FINISH
DL9530A	36" (914 mm) Doors	Satin Aluminum
DL9530DU	36" (914 mm) Doors	Bronze Anodized
DL9535A	42" (1067 mm) Doors	Satin Aluminum
DL9535DU	42" (1067 mm) Doors	Bronze Anodized
DL9540A	48" (1219 mm) Doors	Satin Aluminum
DL9540DU	48" (1219 mm) Doors	Bronze Anodized

Minimum order: 1 each. All Push Bars can be combined for quantity pricing.

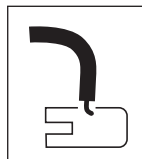

J-Hook Mount

CRL Sex Bolts

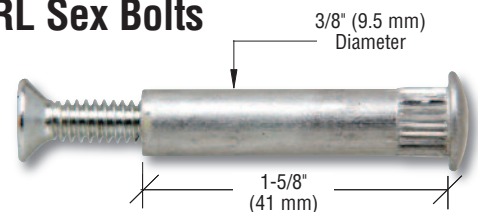

Used for securing push bars, surface mounted door closers, and other fixtures to 1-3/4" (45 mm) doors. Knurled barrel fits a 3/8" (9.5 mm) diameter hole. Available in aluminum and bronze finishes. Four bolts per package.

CAT. NO.	THREAD SIZE	FINISH
8025	1/4" - 20	Satin Aluminum
8025BRZ	1/4" - 20	Bronze Anodized

Minimum order: 1 pack. All Sex Bolts can be combined for quantity pricing.

CRL Cross Bar Panic Exit Devices

- Available as Concealed Vertical Rod and Rim Exit Devices
- For Use With Narrow, Medium, and Wide Stile Aluminum Doors or Hollow Metal Doors

CRL's DL1100 Series Cross Bar Exit Device is a proven product for providing an economical solution to satisfy both security and life safety requirements. This Exit Device comes with a 42" (1.07 m) long cross bar that can be field cut to fit your exact door size requirements.

CAT. NO.	TYPE	FINISH
DL1180A	Concealed Vertical Rod	Satin Aluminum
DL1180DU	Concealed Vertical Rod	Dark Bronze
DL1190LHRA	Left Hand-Reverse Bevel Rim	Satin Aluminum
DL1190RHRA	Right Hand-Reverse Bevel Rim	Satin Aluminum
DL1190LHRDU	Left Hand-Reverse Bevel Rim	Dark Bronze
DL1190RHRDU	Right Hand-Reverse Bevel Rim	Dark Bronze

Minimum order: 1 each. All Panic Exit Devices can be combined for quantity pricing.



STANDARD FEATURES:

DL1180 Series Concealed Vertical Rod Panics

- Non-Handed
- For Use With Standard 1-3/4" (45 mm) Thick Doors
- Rod Length to Fit Standard 84" (2134 mm) Tall Doors
- Independent Top and Bottom Bolt Action – 1/2" (12 mm) Bolt Throw
- Keyed Entry Requires CRL Cat. No. DL913 Cylinder Mounting Pad When Using Optional CRL DL2170 Series, or other brand, Mortise Cylinders

DL1190 Series Rim Panics

- Handed, Non-Reversible
- For Use With Aluminum or Hollow Metal Doors
- Standard Surface Mounted Roller Type Rim Strike Supplied
- Keyed Entry Requires Optional CRL DL911SC Series, or other brand, Rim Cylinder (No Mounting Pad Required)

CRL DL950 Push-Pad Rim Panic Exit Devices

- For Use With Narrow, Medium, and Wide Stile Aluminum Doors
- Non-Handed and Reversible

Our Push-Pad Rim Panic Devices can be used on either single doors, or double doors with a mullion. Minimum recommended door stile width is 4-1/4" (108 mm). For your convenience, these Devices come fabricated to 34-7/8" (886 mm) overall length, ready to install on 36" (914 mm) wide doors without any modification, and may be cut down to fit doors as narrow as 30" (762 mm). A dogging feature defeats locking action during business hours. A Blade Strike is included with each Exit Device.

CAT. NO.	TYPE	FINISH
DL950A	Push-Pad Rim	Satin Aluminum
DL950DU	Push-Pad Rim	Dark Bronze
DL950S	Push-Pad Rim	Satin Stainless Steel

Minimum order: 1 each. All Panic Exit Devices can be combined for quantity pricing.



For keyed entry, an optional Cat. No. DL911SC Series, or other brand, Rim Cylinder is required.



Standard Blade Strike



Latch Detail

CRL 1900 Narrow Stile Push-Pad Rim Panic Exit Devices

- For Use With 1-3/4" Narrow, Medium, and Wide Stile Aluminum Doors, Wood or Hollow Metal Doors
- Non-Handed and Reversible

These CRL 1900 Series Narrow Stile Panic Exit Devices are designed for 1-3/4" (45 mm) narrow stile aluminum doors, but can also be used with medium and wide stile aluminum, wood or hollow metal doors. The base is field sizeable, and fits doors 30" to 44" (762 to 1118 mm) wide and 1-3/4" (45 mm) thick. Ruggedly constructed with 3/4" (19 mm) throw cast brass latch bolt. Surface mounted adjustable roller strike included. Device is non-handed and is easy to install.

CAT. NO.	TYPE	FINISH
1900A	Push-Pad Rim	Satin Aluminum
1900BRZ	Push-Pad Rim	Dark Bronze

Minimum order: 1 each. All Panic Exit Devices can be combined for quantity pricing.



For keyed entry, an optional Cat. No. DL911SC Series, or other brand, Rim Cylinder is required.

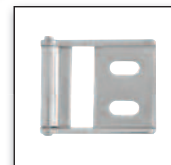

Roller Strike



Latch Detail

CRL Jackson Panic Exit Devices

- Designed for Use With 1-3/4" Narrow, Medium, and Wide Stile Aluminum, Wood or Hollow Metal Doors
- Concealed Fastening for Added Security

CRL Jackson 10 Series Panic Exit Devices

Jackson Exit Devices are universally recognized as the standard for aluminum storefront hardware. This crossbar device was designed with simplicity in mind, yet it will provide many years of smooth, reliable operation. Available in both a Rim and Concealed Vertical Rod version, this Device is suitable for use with 1-3/4" (45 mm) narrow, medium, and wide stile aluminum, wood, or hollow metal doors. The 48" (1219 mm) long contoured crossbar is field sizeable, and the Device is shipped to fit up to 84" (2134 mm) tall doors. Extensions for taller doors are available.

Visit crlaurence.com for more information.

The 10 Series Exit Device is the perfect solution when considering a reliable, maintenance free means to satisfy life safety requirements. For Model 1085 keyed entry, a No. 86 Mounting Pad is required when using optional CRL DL2170 Series, or other brand, Mortise Cylinder. For Model 1095 keyed entry, an optional CRL DL911SC Series, or other brand, Rim Cylinder is required, but a Mounting Pad is not required. Visit crlaurence.com for cylinders and accessories.

CAT. NO.	TYPE	HANDING	FINISH
1095A42L	Rim	Left Hand-Reverse Bevel	Satin Aluminum
1095A42R	Rim	Right Hand-Reverse Bevel	Satin Aluminum
1095BRZ42L	Rim	Left Hand-Reverse Bevel	Dark Bronze
1095BRZ42R	Rim	Right Hand-Reverse Bevel	Dark Bronze
1085A42	Concealed Vertical Rod	Non-Handed	Satin Aluminum
1085BRZ42	Concealed Vertical Rod	Non-Handed	Dark Bronze

Minimum order: 1 each. All Panic Exit Devices can be combined for quantity pricing.



Model 1095
Rim Type



Model 1085
Concealed Vertical Rod Type

FEATURES:

- Contoured Field Sizeable 48" (1219 mm) Long Crossbar
- Standard Door Height 84" (2134 mm) – Extension Available
- Dual Dogging Feature– By Outside Cylinder
– By Dogging Pins on Panic Housing
- Wear Points Insulated by Nylon Sleeves and Rollers

MATERIALS:

Body and Arms: High Tensile Strength Aluminum
Mechanical Components: Stainless and Hardened Plated Steel
Latch and Strikes: Sintered Steel

CRL Jackson 20 Series Panic Exit Devices

This Jackson Exit Device is designed to withstand wear and tear, yet remain aesthetically pleasing. Each part is manufactured from the highest quality materials, which are hand fitted and adjusted for a smooth, whisper quiet operation. The Touch Pad with "Soft-Touch" insert requires only slight pressure anywhere on bar insert for a smooth release.

Available in both a Rim and Concealed Vertical Rod version, this Device is suitable for use with 1-3/4" (45 mm) narrow, medium, and wide stile aluminum, wood, or hollow metal doors. It has been certified to ANSI 156.3 – Grade 1 specification, and is available with optional high-impact resistance upgrades. For doors wider than 36" (914 mm), field sizeable lengths up to 48" (1219 mm) are available on special order. Extensions for doors taller than 84" (2134 mm) are available. Visit crlaurence.com for more information.

For Model 2085 keyed entry, a No. 86 Mounting Pad is required when using optional CRL DL2170 Series, or other brand, Mortise Cylinder. For Model 2095 keyed entry, an optional CRL DL911SC Series, or other brand, Rim Cylinder is required, but a Mounting Pad is not required. For active outside trim and other panic accessories, visit crlaurence.com.

CAT. NO.	TYPE	HANDING	FINISH
2095A36L	Rim	Left Hand-Reverse Bevel	Satin Aluminum
2095A36R	Rim	Right Hand-Reverse Bevel	Satin Aluminum
2095BRZ36L	Rim	Left Hand-Reverse Bevel	Dark Bronze
2095BRZ36R	Rim	Right Hand-Reverse Bevel	Dark Bronze
2085A36L	Concealed Vertical Rod	Left Hand-Reverse Bevel	Satin Aluminum
2085A36R	Concealed Vertical Rod	Right Hand-Reverse Bevel	Satin Aluminum
2085BRZ36L	Concealed Vertical Rod	Left Hand-Reverse Bevel	Dark Bronze
2085BRZ36R	Concealed Vertical Rod	Right Hand-Reverse Bevel	Dark Bronze

Minimum order: 1 each. All Panic Exit Devices can be combined for quantity pricing.



Model 2095
Rim Type

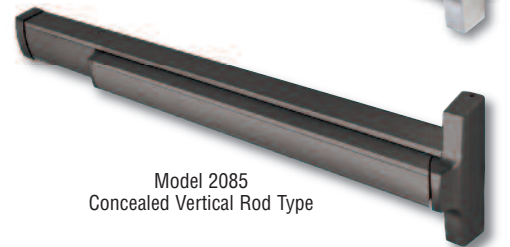

Model 2085
Concealed Vertical Rod Type

FEATURES:

- Standard 36" (914 mm) Wide Door - Field Sizeable up to 48" (1219 mm) Width Available on Special Order
- Standard Door Height 84" (2134 mm) – Extension Available
- Concealed Easy to Use Dogging System – Optional Cylinder Dogging Available on Special Order
- Wear Points Insulated by Nylon Sleeves and Rollers

MATERIALS:

Body and Push Pad: Extruded Aluminum
Mechanical Components: Stainless and Hardened Plated Steel
Latch and Strikes: Sintered Steel

CRL Jackson 1200 Series Panic Exit Devices



new



- Designed for Use With 1-3/4" Narrow, Medium, and Wide Stile Aluminum, Wood or Hollow Metal Doors
- "Soft-Touch" Smooth Action Push-Pad
- Field Sizeable

This Jackson Exit Device blends the reliability of the time-proven Jackson 10 Series Crossbar Device with the sleek, contemporary style of today's modern push-pad exit device. Available in a Rim, Concealed, and Surface Vertical Rod versions, this device is suitable for use with 1-3/4" (45 mm) narrow, medium, and wide stile aluminum, wood, or hollow metal doors. The base is easily trimmed for field sizing, and the vertical rods are shipped to fit up to 84" (2134 mm) tall doors. Extensions or longer rods for taller doors are available on special order. This Exit Device features an easy to use dogging system, and is available with keyed cylinder dogging on special order.

The 1200 Series touch pad with "Soft-Touch" insert requires slight pressure anywhere on bar insert for instant release of the locking mechanism. Overall projection is only 2-7/8" (73 mm) from the door surface, and mounting hardware is concealed. Visit crlaurence.com for active outside trim and other panic accessories.



CAT. NO.	TYPE	HANDING	FINISH
1275A36X84	Surface Vertical Rod	Non-Handed	Satin Aluminum
1275BRZ36X84	Surface Vertical Rod	Non-Handed	Dark Bronze
1285A36L	Concealed Vertical Rod	Left Hand-Reverse Bevel	Satin Aluminum
1285A36R	Concealed Vertical Rod	Right Hand-Reverse Bevel	Satin Aluminum
1285BRZ36L	Concealed Vertical Rod	Left Hand-Reverse Bevel	Dark Bronze
1285BRZ36R	Concealed Vertical Rod	Right Hand-Reverse Bevel	Dark Bronze
1295A36	Rim – 36" (914 mm) Base	Non-Handed	Satin Aluminum
1295BRZ36	Rim – 36" (914 mm) Base	Non-Handed	Dark Bronze
1295A48	Rim – 48" (1219 mm) Base	Non-Handed	Satin Aluminum
1295BRZ48	Rim – 48" (1219 mm) Base	Non-Handed	Dark Bronze

Minimum order: 1 each. All Panic Exit Devices can be combined for quantity pricing.

SPECIFICATIONS:

1275 Surface Vertical Rod Device

- Standard 36" (914 mm) Wide Door
- 48" (1219 mm) Width Available on Special Order
- Standard Door Height 84" (2134 mm) – Field Sizeable 120" (3048 mm) Tall Available on Special Order

1285 Concealed Vertical Rod

- Standard 36" (914 mm) Wide Door
- 48" (1219 mm) Width Available on Special Order
- Standard Height 84" (2134 mm) - Extension Available
- Requires Cat. No. 86 Cylinder Mounting Pad When Using Mortise Cylinder for Keyed Outside Entry

1295 Rim Device

- Stocked in Both 36" (914 mm) and 48" (1219 mm) Widths
- Surface Mounted Roller Strike Standard
- Requires Rim Cylinder for Keyed Entry

MATERIALS:

Base and Push Pad: Extruded Aluminum
Mechanical Components: Stainless and Hardened Plated Steel
Latch and Strikes: Sintered Steel

CRL Jackson 10 Series Push-Pad Retrofit Device

new



- Sleek, Contemporary Style Push-Pad to Retrofit Existing Jackson 1085 Concealed Vertical Rod Crossbar Exit Device
- Uses Existing 10 Series Rod and Case Assembly
- Easy Installation – Field Sizeable

This Retrofit Push-Pad for the Jackson 1085 Concealed Vertical Rod Panic Exit Device is designed to replace the existing crossbar while utilizing the existing internal rod and case assembly. All necessary conversion hardware is included, and the installation simply requires attaching the new push-pad base to the door. The overall projection of the device is only 2-7/8" (73 mm) from the door surface.

CAT. NO.	TYPE	FINISH
1285RETA36L	Left Hand-Reverse Bevel	Satin Aluminum
1285RETA36R	Right Hand-Reverse Bevel	Satin Aluminum
1285RETBZ36L	Left Hand-Reverse Bevel	Dark Bronze
1285RETBZ36R	Right Hand-Reverse Bevel	Dark Bronze

Minimum order: 1 each. All Panic Exit Devices can be combined for quantity pricing.

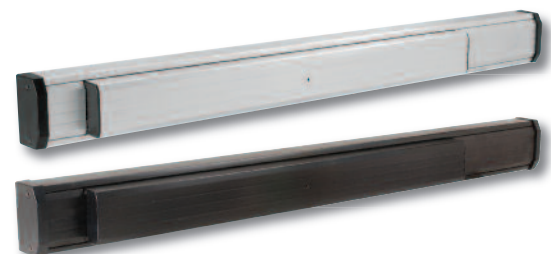

SPECIFICATIONS:

- Standard 36" (914 mm) Wide Door
- 48" (1219 mm) Width Available on Special Order

MATERIALS:

Base and Push Pad: Extruded Aluminum
Mechanical Components: Stainless and Hardened Plated Steel

CRL TAPER-LOC™ Taper Sets

- Designed for Residential and Commercial Applications
- Available for Both Laminated Tempered and Monolithic Tempered Glass Applications
- Meets and Exceeds Code Standards
- Reduces Installation Time by 50%
- No Clean Up or Mixing of Messy Wet Cement
- Miami-Dade County Certified and IBC Compliant
- For All Engineering and Testing Reports
Visit crlaurence.com

new



For Monolithic Tempered Glass

For Laminated Tempered Glass

• Glass Magazine 2009 Crystal Achievement Award for "Most Innovative Commercial Hardware Product"

C.R. Laurence Company proudly offers the innovative GRS Glass Railing Dry Glazed TAPER-LOC™ System. Designed for residential and commercial applications, this system works with laminated tempered and monolithic tempered glass railing and windscreen applications.

This unique system uses a horizontal taper lock design. TAPER-LOC™ Tapers are simply installed with CRL's exclusive TLK9 Installation/Removal Tool. This tool mechanically slides the Tapers horizontally and compresses them together to secure the glass in the aluminum base shoe without the use of messy wet cement. When compressed, they expand in thickness and lock in place. When the correct lock-up force is applied, the torque wrench will click and break for a few degrees of rotation. The same tool will also loosen the Tapers for glass alignment or replacement. The CRL TAPER-LOC™ System reduces installation time by up to 50%, supports all mounting methods, and is designed to meet and exceed code standards.

We supply the entire range of railing accessories and tools which partner perfectly with CRL's Heavy Aluminum Base Shoe and Premium Top Cap Rails. We can also assist with your design plans. It's all part of CRL's commitment to the glass railing industry. For full details contact CRL Railing Technical Sales at (800) 421-6144 in the U.S., (877) 421-6144 from Canada, or (323) 588-1281 International, and ask for Ext. 7730. Send e-mail to railings@crlaurence.com.

TAPER-LOC™ Installation/Removal Tool Kit

- One Tool Supports All CRL TAPER-LOC™ Sizes

See opposite page for more information

CAT. NO. TLK9



Installation Labor Time Reduced by 50%



- STEP 1** - Place the TAPER-LOC™ Tapers into base shoe finger tight
- STEP 2** - Place the TAPER-LOC™ Installation/Removal Tool into position
- STEP 3** - Tighten the TAPER-LOC™ components using our measured Torque Wrench and you're done

PAL Plumb/Angle/Level Locator Kit

- Great for Leveling the Base Shoe for Railing and Windscreen Application
- Levels Base Shoe in Both Horizontal and Vertical Orientations
- Comes Complete With Everything Needed for Your Layout



CAT. NO. PAL1K

- CAT. NO. PAL1K PAL Plumb/Angle/Level Locator Kit With Digital Laser Tool
 CAT. NO. PAL0K PAL Plumb/Angle/Level Locator Kit Without Digital Laser Tool

CRL TAPER-LOC™ Taper Set for Laminated Tempered Glass

new

- Designed for 9/16" (13.52 mm) Laminated Tempered Glass (6.4 mm x 1.52 mm x 6.4 mm)
- Also Designed for 27/32" (21.52 mm) Laminated Tempered Glass (10 mm x 1.52 mm x 10 mm) and 1-1/16" (25.52 mm) Laminated Tempered Glass (12 mm x 1.52 mm x 12 mm)
- For Use With CRL's L56S, L21S, and L25S Laminated Tempered Glass Railing Base Shoes Only

Great for Stadiums, Condos, or any areas trying to avoid the hazard of broken glass falling to lower levels. CRL's TAPER-LOC™ Laminated Glass Taper Set is made up of four Tapers and one L-Setting Block. Tapers are made of high strength reinforced nylon. They expand in thickness when compressed together with the Cat. No. TLK9 Installation/Removal Tool, mechanically locking the glass panel into the base shoe. Minimum order is 10 Sets.



CAT. NO. LTL10
(for 27/32" or 1-1/16" Laminated)

CAT. NO. LTL96
(for 9/16" Laminated)

CRL TAPER-LOC™ Taper Set for 3/8" (10 mm) Monolithic Tempered Glass

- Great for Glass Windscreen Applications
- For Use With CRL's W5B Windscreen Base Shoe
- 36" (914 mm) Recommended Maximum Glass Height

CRL's TAPER-LOC™ Taper Set for 3/8" (10 mm) glass is made up of two Tapers and one L-Setting Block. Tapers are made of high strength reinforced nylon. They expand in thickness when compressed together with the Cat. No. TLK9 Installation/Removal Tool, mechanically locking the glass panel into the base shoe. Not designed for guard rail applications or laminated glazing. Minimum order is 10 Sets.

new

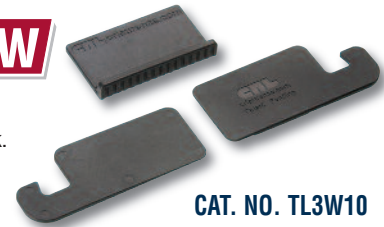

CAT. NO. TL3W10

CRL TAPER-LOC™ Taper Set for 1/2" (12 mm), 15 mm, and 3/4" (19 mm) Monolithic Tempered Glass

- Great for Glass Railing and Windscreen Applications
- For Use With CRL's B5S, B5T, B6S, and B7S Glass Railing Base Shoes

CRL's TAPER-LOC™ Taper Set for 1/2" to 3/4" (12 to 19 mm) glass is made up of two Tapers and one L-Setting Block. Tapers are made of high strength reinforced nylon. They expand in thickness when compressed together with the Cat. No. TLK9 Installation/Removal Tool, mechanically locking the glass panel into the base shoe. Not designed for Laminated Glazing. Minimum order is 10 Sets.



CAT. NO. TL5W10

CRL TAPER-LOC™ Installation/Removal Tool Kit

- This One Kit Works With Both Monolithic Tempered and Laminated Tempered Glazing Types
- Easily Allows You to Install, Adjust, or Replace Glass Panels in Seconds
- Complete With a Torque Wrench Designed for Precise Lock-Up Force

The TLK9 Installation/Removal Tool is used for tightening TAPER-LOC™ Tapers in the channel of the base shoe. It has an Integrated Torque Wrench that applies the precise lock-up force necessary to set the glass panels. Simply set in place and turn the wrench until a clicking sound is heard. This assures the Tapers have been locked together. It can also remove Tapers when glass panels need to be reset or replaced. The TLK9 Tool comes with an Integrated Torque Wrench, a Glass Railing Setting Tool for Monolithic Glass, a Glass Railing Setting Tool for Laminated Glass, a pair of Glass Setting Roller Blocks, Instructions, and an assortment of Compression Blades. The Blade Assortment includes one pair of Blue Blades and Pusher Plate for monolithic surface mount guard rail and railing installs; one pair of Yellow Blades and Pusher Plate for monolithic windscreen installs; one pair of Red Blades and Pusher Plate for monolithic recessed mount guard rail and railing installs; one black Pusher Plate for all laminated glass installs. Everything is contained in a molded carrying case. Minimum order is one each.

new



CAT. NO. TLK9

CRL Upgrade Kit for Original TLK5 Installation/Removal Tools

new

- Allows Older TLK5 Kits to Work With All Monolithic Tempered and Laminated Tempered Glass Installs
- Color Coded Blades and Pusher Plates for Easy Identification and Matching

This Upgrade Kit is available to bring your original TLK5 TAPER-LOC™ Installation/Removal Tool Kit current and enables one tool to work with all different base shoes and glass thicknesses. The Kit consists of: one pair of Yellow Blades and Pusher Plate for monolithic windscreen installs; one pair of Blue Blades and Pusher Plate for monolithic surface mount guard rail and railing installs; one pair of Red Blades and Pusher Plate for monolithic recessed mount guard rail and railing installs; one black Pusher Plate for all laminated glass installs, and a Laminated Glass Setting Tool. Minimum order is one each.



CAT. NO. TLK7

CRL Aluminum Base Shoe for Laminated and Tempered Glass

new

- Typically Used as the Base Channel for Glass Railing Systems or Windscreens
- Drilled and Counter Bored, or We Will Custom Drill to Your Specifications
- Custom Cutting and Mitering Service
- Custom Cladding and End Caps

See Page L237 for Taper Sets



CRL L56S Series Standard Square Base Shoe

new

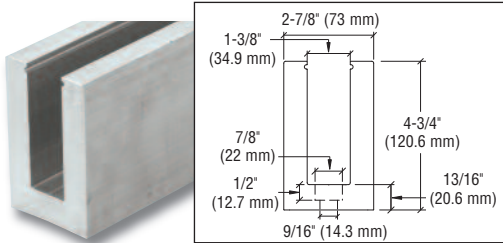

- For 9/16" (13.52 mm) Laminated Tempered Glass
- Pre-Drilled in 10 Foot (3.05 m) Lengths
- Works With LTL96 TAPER-LOC™ Taper Sets

CAT. NO.
L56S10D

STOCK LENGTH
10 Feet (3.05 m)

Minimum order: 1 each. All Base Shoe can be combined for quantity pricing. Must ship common carrier. Stock lengths have a tolerance of plus or minus 3/4" (19 mm).

CRL L21S Series Standard Square Base Shoe

new

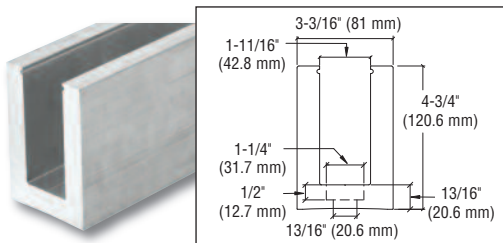

- For 27/32" (21.52 mm) Laminated Tempered Glass
- Pre-Drilled in 3 Meter (118") Lengths
- Works With LTL10 TAPER-LOC™ Taper Sets

CAT. NO.
L21S10D

STOCK LENGTH
118" (3 m)

Minimum order: 1 each. All Base Shoe can be combined for quantity pricing. Must ship common carrier. Stock lengths have a tolerance of plus or minus 3/4" (19 mm).

CRL L25S Series Heavy-Duty Square Base Shoe

new

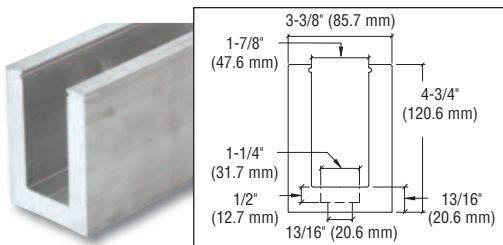

- For 1-1/16" (25.52 mm) Laminated Tempered Glass
- Pre-Drilled in 3 Meter (118") Lengths
- Works With LTL10 TAPER-LOC™ Taper Sets

CAT. NO.
L25S10D

STOCK LENGTH
118" (3 m)

Minimum order: 1 each. All Base Shoe can be combined for quantity pricing. Must ship common carrier. Stock lengths have a tolerance of plus or minus 3/4" (19 mm).

CRL B6S Series Standard Square Base Shoe

new

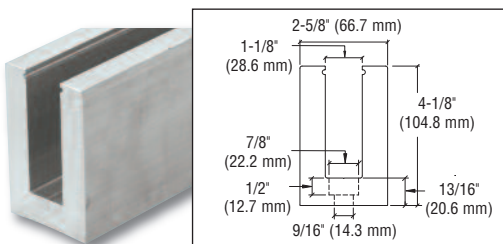

- For 15 mm Monolithic Tempered Glass
- Pre-Drilled in 3 Meter (118") Lengths
- Works With TL5W10 TAPER-LOC™ Taper Sets

CAT. NO.
B6S10D

STOCK LENGTH
118" (3 m)

Minimum order: 1 each. All Base Shoe can be combined for quantity pricing. Must ship common carrier. Stock lengths have a tolerance of plus or minus 3/4" (19 mm).

CRL B5S Series Standard Square Base Shoe

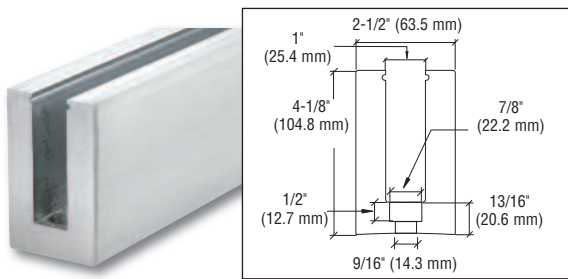

- For 1/2" to 5/8" (12 to 16 mm) Monolithic Tempered Glass
- Pre-Drilled in 10 and 20 Foot Lengths
- Works With TL5W10 TAPER-LOC™ Taper Sets

CAT. NO.	STOCK LENGTH
B5S10D	10 Feet (3.05 m)
B5S20D	20 Feet (6.10 m)

Minimum order: 1 each. All Base Shoe can be combined for quantity pricing. Must ship common carrier. Stock lengths have a tolerance of plus or minus 3/4" (19 mm).

CRL B5T Series Tapered Base Shoe

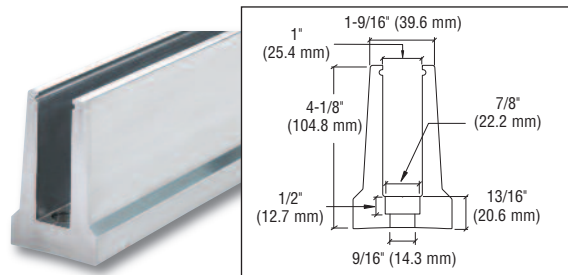

- For 1/2" to 5/8" (12 to 16 mm) Monolithic Tempered Glass
- Typically Used When a Flush Installation Embedded in Concrete is Required
- Works With TL5W10 TAPER-LOC™ Taper Sets

CAT. NO.	STOCK LENGTH
B5T10D	10 Feet (3.05 m)
B5T20D	20 Feet (6.10 m)

Minimum order: 1 each. All Base Shoe can be combined for quantity pricing. Must ship common carrier. Stock lengths have a tolerance of plus or minus 3/4" (19 mm).

CRL B7S Series Heavy-Duty Square Base Shoe

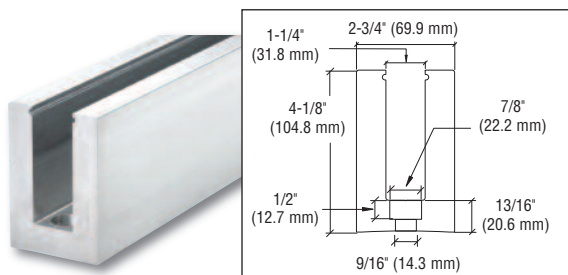

- For 3/4" (19 mm) Glass Monolithic Tempered Glass
- Pre-Drilled in 10 and 20 Foot Lengths
- Works With TL5W10 TAPER-LOC™ Taper Sets

CAT. NO.	STOCK LENGTH
B7S10D	10 Feet (3.05 m)
B7S20D	20 Feet (6.10 m)

Minimum order: 1 each. All Base Shoe can be combined for quantity pricing. Must ship common carrier. Stock lengths have a tolerance of plus or minus 3/4" (19 mm).

CRL B5L Series Low Profile* Square Base Shoe

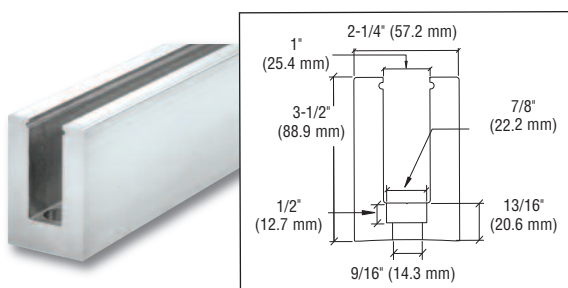

- For 1/2" to 5/8" (12 to 16 mm) Monolithic Tempered Glass
- Pre-Drilled in 10 and 20 Foot Lengths

CAT. NO.	STOCK LENGTH
B5L10D	10 Feet (3.05 m)
B5L20D	20 Feet (6.10 m)

Minimum order: 1 each. All Base Shoe can be combined for quantity pricing. Must ship common carrier. Stock lengths have a tolerance of plus or minus 3/4" (19 mm).

*Low Profile Square Base Shoe cannot be used with the TAPER-LOC™ Glazing System.

CRL W5B Series Small Profile Windscreen Base Shoe

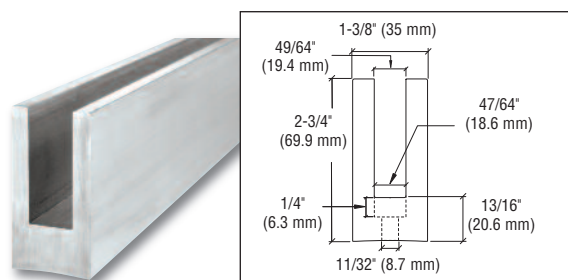

- For 3/8" to 1/2" (10 to 12 mm) Monolithic Tempered Glass
- Pre-Drilled in 10 and 20 Foot Lengths
- Works With TL3W10 TAPER-LOC™ Taper Sets

CAT. NO.	STOCK LENGTH
W5B10D	10 Feet (3.05 m)
W5B20D	20 Feet (6.10 m)

Minimum order: 1 each. All Base Shoe can be combined for quantity pricing. Must ship common carrier. Stock lengths have a tolerance of plus or minus 3/4" (19 mm).

CRL 'All-Glass' Storefronts Online®

Web-Based Design, Estimating, and Ordering Program for 'All-Glass' Entrances

- Produces a Complete Quote Package From Your Desktop in Minutes
- Produces Every Glass Size Required for Your 'All-Glass' Entrance
- Determines All Hardware Quantities Needed for Each Project
- Allows You to Order Material Directly From Your Computer
- Produces a Full Color 3D Rendering and Dimensioned Plan View for Field Installation

*There's
Nothing Else
Like 'All-Glass'
Storefronts
Online®!*

*Ask About
Our FREE
30 Day
Trial Offer*



Is This Program for You?

- Do You Quote and Install 'All-Glass' Entrances?
- Need Help Designing Safe Entrances?
- Need Professional Drawings for Proposals?
- Want to Grow This Part of Your Business?

If you answered YES to any of these questions, then 'All-Glass' Storefronts Online® is the right software for you! Join the growing number of designers and installers that are using the 'All-Glass' Storefronts Online® Design, Estimating, and Ordering System and reap the benefits of saved time and money!

Our program is tailored for use with most any of our 'All-Glass' Storefront systems and hardware for 3/8", 1/2", and 3/4" (10, 12, and 19 mm) thick glass, including doors, sidelites, transoms, and fin support with full top and bottom rails or patch fittings. 'All-Glass' Storefronts Online® takes your rough notes and dimensions and transforms them into finished quotes complete with 3D drawings and confirmations you can use with your customers to secure more projects quickly and easily. When you are ready to order your hardware and glass for the job, 'All-Glass' Storefronts Online® prepares glass fabrication sheets and allows you to order all your needed hardware online. It just doesn't get any easier than this!

*'All-Glass' Storefronts Online® is Just One of Our
Family of Online Services, Including Hand Rails
Online, and Showers Online*

Benefits of Using 'All-Glass' Storefronts Online®

- 'All-Glass' Storefronts Online® is a web-based program, so you can log on from any computer that is connected to the World Wide Web.
- No need to download or maintain any software. The entire program is run on our servers so you do not need any special hardware to run it. Any PC with a minimum 56K modem can be used.
- 'All-Glass' Storefronts Online® calculates needed hardware and glass sizes, supplies necessary cutout templates, and generates quote and installation sheets.
- Warnings are given regarding any issues that conflict with a complete and sound entrance.
- 'All-Glass' Storefronts Online® starts you out with many easy to use templates of entrances, but also allows you to build your own library of your most common designs. You can also copy and modify past jobs.
- Easy to print out elevations can be saved as PDF files and used as confirmations to your customers.

CRL 'All-Glass' Storefronts Online®

Web-Based Design, Estimating, and Ordering Program for 'All-Glass' Entrances

- Design Most Any Custom 'All-Glass' Entrance in Minutes
- Get Accurate Glass Sizes Immediately
- Produce More Professional Quotes With Presentation Drawings
- 'All-Glass' Storefronts Online is Web-Based, There is No Program to Load
- Everything is Run Off Our Servers
- Technical Sales Team Available to Help Train You to Easily Design and Estimate 'All-Glass' Entrances
- Webinars Get You Off to a Fast Start

Step 1: Simply Click on the Desired Storefront Configuration and Use the Provided Menu

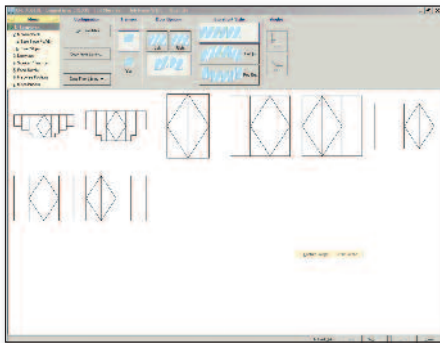

Step 2: Enter the Finished Opening Sizes for Your Project

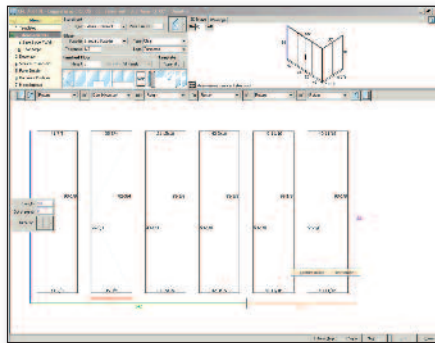

Step 3: Choose the Door Type You Will Be Using and the Desired Hardware

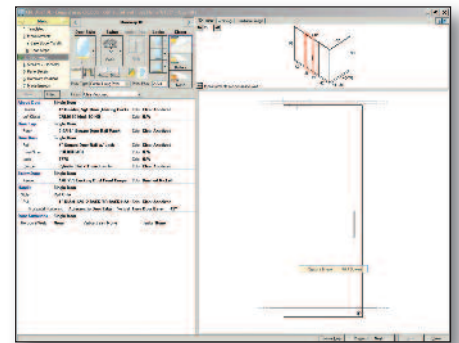

Step 4: Specify Any Fixed Panel Requirements

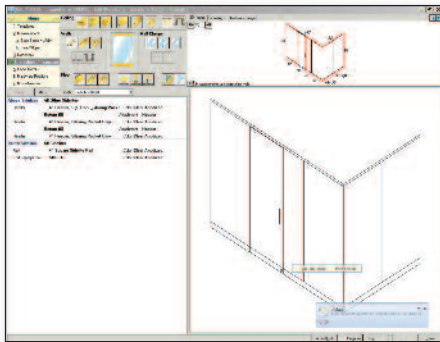

Step 5: Add Additional CRL Products Required for the Job

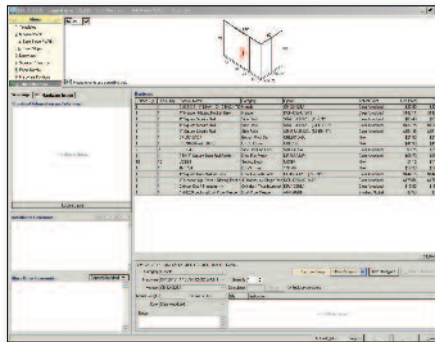

Step 6: Final Printouts of Layout, Hardware List, Glass Sizes Generated, and 3D Drawings for Job Confirmation

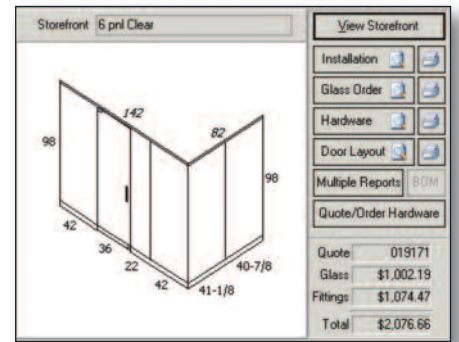

Step 7: Request a Hardware Quote Online and Receive Pricing Instantly

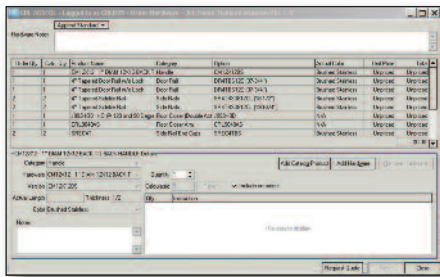

Step 8: Place Your Order for Quoted Hardware Online - Quick and Easy

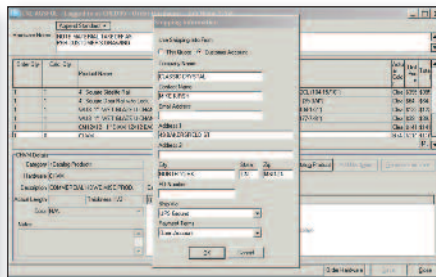

You can be up and running in 15 minutes, creating quotes, hardware lists, and glass sizes faster than ever before! Our Technical Sales Department will be glad to walk you through the initial details of 'All-Glass' Storefronts Online®, and then "shadow" you as you actually use the program. Our Specialists use the program themselves, so they are most qualified to make you an expert user. For more information, contact CRL Technical Sales at (800) 421-6144 in the U.S., (877) 421-6144 from Canada, or (323) 588-1281 International, and ask for Ext. 7700. You can also e-mail us through our web site at crlaurence.com. From the home page click on Contact Us, and then click on Technical Sales for Commercial Products.

Welcome to the C.R. Laurence Online Catalog

- Thousands of Pages of Quality Products and Helpful Information are Just Clicks Away, Anytime, and at Your Convenience



What's the best way to shop at C.R. Laurence? Visit the Online Catalog at crlaurence.com. Our Online Catalog brings you thousands of pages from our many printed catalogs. All of them in full color, and linked to our ordering module so you can browse and shop at any time it's convenient. You can check prices, review stock levels, and get the most complete and up-to-date details on the products we offer. And you can do it all from any PC.

Our full service web site and Online Catalog are the most comprehensive and convenient up-to-date information sources we can offer. Explore some of our most popular product lines or review individual products. CRL has over 50,000 of them organized by specific product categories.

The convenience of having all CRL catalogs combined into one Online Catalog is the quick and easy way to find just what you need, available at your convenience, whenever you're ready. And if you ever need assistance, just contact us over the Internet or by toll free phone. We'll be glad to help.

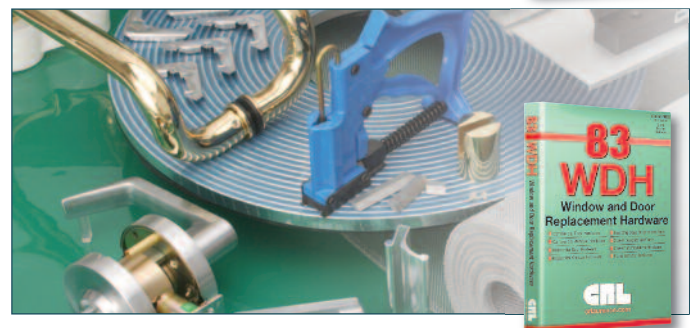
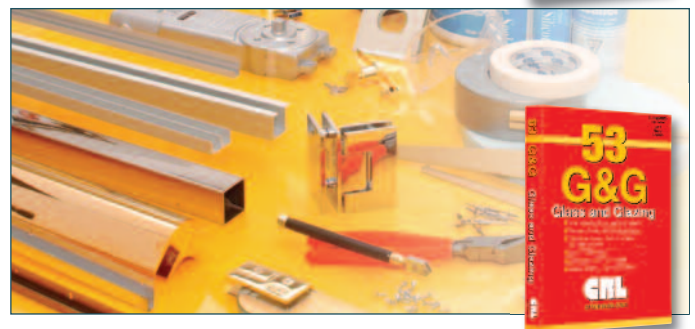

The screenshot shows the C.R. Laurence Co., Inc. website interface. At the top, there is a navigation bar with the CRL logo, company name, and a 'Click Here For GLOBAL DIRECTORY' link. A search bar is prominently displayed with a 'Sign On' button and a 'My CRL' link. Below the navigation bar, there are several menu categories: Frameless Shower Door, Storefronts & Entrances, Architectural Railings, Architectural Metals, Transaction Hardware, Hospitality & Display, Automotive Products, Sommer & Maca Machinery, Contact Us, and Quote Request. A central banner features a 'PRODUCT SHOWCASE' with various tools and materials, including gloves, a power drill, and a saw. Text on the banner reads: 'CRL SILICONES, ABRASIVES, AND MORE ARE ON SALE IN OCTOBER AND NOVEMBER'. Below this, there are two smaller sections: 'New Product Showcase' and 'Frameless Shower Doors Marketing Tips'. The 'New Product Showcase' section highlights new products and includes a 'CLICK HERE' link. The 'Marketing Tips' section offers videos to help increase shower door sales. At the bottom of the banner, there is a 'New Catalogs Available' section with five catalog covers: SD10 (Frameless Shower Door Hardware), LP11 (Commercial Door Handles), GB10 (Glass Bonding Hardware), TH10 (Transaction Hardware), and a 'NEW' tag. On the right side of the interface, there is a vertical sidebar with links for 'Ordering', 'Quick Pricing and Stock Check', 'Click Here to Place an Order', 'Products', 'Doing Business', 'CRL Sites', 'Upcoming Events', 'Showers Handrails Storefronts Online', and '99R Silicone Final Close-Out Sale 99¢'. A left sidebar contains a 'Customer Menu Bar' with links for 'Not a CRL Customer?', 'Searching on CRL', 'Products & Services', 'General Information', and 'Online Applications Login'.

Of all the products we bring you, our Online Catalog may be the most important. We know that the most efficient way for our customers to shop at CRL is by using this carefully planned and thoroughly prepared Online Catalog to make it easy for them to find exactly what they need. C.R. Laurence Company is committed to making our Online Catalog your best source for information and technical support.

What you will find at crlaurence.com is a link to who we are, what we do, and what we have to offer our customers. The CRL full service web site allows us to use the powers of Electronic Commerce to bring you closer to all of the products and services that we offer.

We take a Business-to-Business approach of conducting business over the Internet because it gives us so many ways to connect with you. Methods of searching for and ordering products that just a few years ago would have been impossible were it not for the versatility of this powerful tool.

Empowerment is what a good web site is all about. We let you make the decisions that will best serve you. You can build your orders and submit them 24 hours a day, seven days a week, at your convenience. You can review over 50,000 products we make available, including pricing and current stock availability.

All of this and more is available to CRL customers who have signed on to our web site and become part of the world of crlaurence.com.

CRL Policies Information Center

The CRL Policies Information Center is available on our web site, crlaurence.com. It's here that you'll find our policies regarding these aspects of doing business with C.R. Laurence:

- Catalog Policy
- Credit Terms and Policies
- CRL International
- Customer Service
- Custom Order Service
- Fax Service
- Image Use
- Ordering Information
- Privacy Policy
- Product Information
- Shipping Information
- Warranty Policy
- Will Call Policy

C.R. Laurence is a Catalog Company

- Master and Specialty Catalogs in Print and Online
- Thousands of Products Presented in an Organized Manner
- Color Photos and Detailed Illustrations
- Easy to Understand Ordering Information



Of all the products we bring you, our catalogs may be the most important. C.R. Laurence is in the business of making catalogs because we know that the most efficient way for our customers to shop at CRL is through carefully planned and thoroughly prepared catalogs that make it easy for them to find exactly what they need.

Part of our catalog philosophy is to bring more of the information you need, and not overburden you with excess catalog literature. That is why we make our Master Catalogs that usually contain all of the products we offer to certain industries, as well as our Specialty Catalogs that focus on particular product groups. You can select CRL Catalogs for only the areas that pertain to your business, or choose to shop from our Master Catalogs because you like the convenience of finding such a wide variety of products all under one cover.

Master Catalog Selection

- **03 SEALANTS, ADHESIVES, AND FASTENERS**
- **23 FRAMELESS SHOWER DOOR HARDWARE**
- **43 AUTO GLASS TOOLS AND WINDOWS**
- **53 GLASS AND GLAZING HARDWARE**
- **63 ARCHITECTURAL HARDWARE**
- **73 TOOLS, MACHINERY, AND EQUIPMENT**
- **83 WINDOW AND DOOR REPLACEMENT HARDWARE**

Free CRL Catalogs Online

You can also view or download CRL Catalogs free of charge any time at crlaurence.com. Go to the Home Page and click on the button for the CRL Catalog Library.



Once you open the page you'll be able to view full PDF versions of each catalog simply by clicking on the image of that catalog's cover. Browse through them page by page at your convenience. When you find a product that you want more information for, or would like to order, just click on its Catalog Number and you'll go directly to that product's Offer Page. It's another convenient way for you to shop at crlaurence.com.

MASTER CATALOGS

CRL03 Sealants and Fasteners
CRL23 Shower Hardware
CRL33 New Products
CRL43 Automotive
CRL53 Glass and Glazing
CRL63 Architectural
CRL73 Tools and Machinery
CRL83 Window and Door General Supplies

SPECIALTY CATALOGS

GB10 Glass Bonding
SD10 Shower Door Hardware
TH10 Transaction Hardware
LP11 Commercial Door Handles
AH11 Architectural Hardware
AM09 Architectural Metals
HR11 Architectural Railing
DC07 Door Controls
HS07 Hospitality and Service
TV03 Automotive
GM04 Insulated Glass Manual

View any catalog page by CRL page number
 Catalogs in New Format

CRL's Complete Selection of Catalogs

Click on any catalog's image to view, download or learn more about that catalog.

CRL Specialty Catalogs

- Full Color Catalogs Showcasing Specific Product Lines
- Great for Customer Presentations

CRL Specialty Catalogs are available for some of our major product lines. Each catalog is presented in full color, and contains descriptive and informative specifications that will assist your field sales and estimating staff in the selection of the right product to satisfy your customer's needs. We invite you to contact CRL Customer Service by phone, fax, mail or e-mail. You can order them separately, or add them to your regular product orders. You can also view them over the Internet, or download them, when you log onto our web site at crlaurence.com.

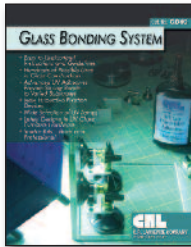

See the latest in UV Glass Bonding tools and accessories including UV Adhesives, Fixation Devices, Curing Lamps, and Unique Hardware. Loaded with full color photos and technical data.

ASK FOR CATALOG GB10



CRL is your source for the largest selection of Frameless Shower Door Hardware and Supplies. See it all, plus a gallery of finished installations, in this informative catalog.

ASK FOR CATALOG SD10



Our full line of Commercial Door Handles, including Ladder Pulls, Locking Ladder Pulls, Center Locks, Deadbolt, Panic, and Electronic Egress Handles. There are photos of finished projects as well as helpful technical data.

ASK FOR CATALOG LP11



Our Architectural Hardware Catalog features our expanded selection of architectural metal and glass hardware for the construction of 'all-glass' entrances in commercial office buildings and storefronts. There are photos of finished projects, as well as helpful technical data.

ASK FOR CATALOG AH11



See the latest in top quality Column Covers (Cladding), Wall Panels, Canopies, Sunshades, and Awnings. There are photos of finished projects, as well as helpful technical data.

ASK FOR CATALOG AM09

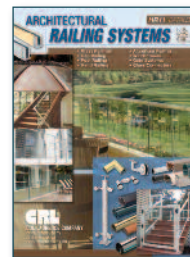

CRL offers the largest selection of Architectural Railing Systems. See them all, plus beautiful photographs of finished installations, in our Railing Systems Catalog.

ASK FOR CATALOG HR11



CRL is your source for the largest selection of Transaction and Security Hardware. Service Windows, Bullet Resistant Windows, Deal Trays, Speak-Thrus, Package Receivers, and more.

ASK FOR CATALOG TH10



Our Hospitality and Service Hardware Catalog introduces CRL's expanded line of Standoffs, Swivel Fittings, Partition Posts, Sneeze Guards, and Glass Barrier Hardware.

ASK FOR CATALOG HS07

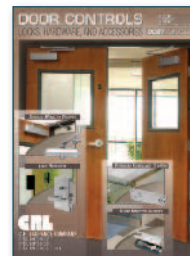

Our line of Door Closers and related Door Control Hardware can be found in this full color catalog. Specifications and ordering information make it easy for you to select the right product every time.

ASK FOR CATALOG DC07

CRL Products are Also Featured in the Sweet's Catalog

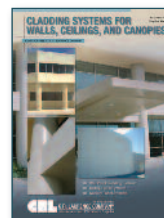

Contact us for free copies of Sweet's Buylines. You can also view them over the Internet, or download them from our web site at crlaurence.com.

Customer Service Order Desk

- Get Product Information
- Request Price Quotes
- Check Stock Availability
- Place or Trace Orders
- Check Your Account Status

Customer Service / Order Desk hours are 6 am to 5 pm (Pacific Time) Monday through Friday, and 7 am to 12 pm Saturday. If you wish to pick up your order at the Will Call counter of our regional warehouses the hours are 8 am to 5 pm Monday through Friday, and 8 am to 12 pm Saturday. For the fastest Will Call service be sure to place your order in advance so we can have it ready upon your arrival.

Ask for Extension

5275

Direct Fax
(800) 262-3299

Direct E-Mail
crl@crlaurence.com



CRL03

CRL23

CRL43

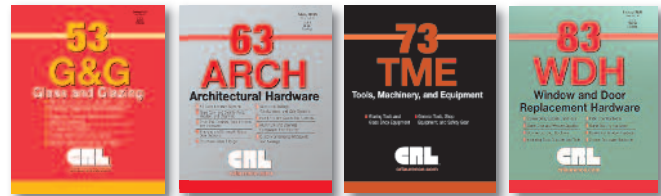

CRL53

CRL63

CRL73

CRL83

Technical Sales Business Groups

Architectural Hardware

- Architectural Storefronts
- 'All-Glass' Entrance Systems
- Door and Sidelite Rails
- Glass Walls and Partitions
- Structural Glass Fittings
- Door Controls

Ask for Extension

7700

Direct Fax (800) 587-7501

Direct E-Mail architectural@crlaurence.com

AH11

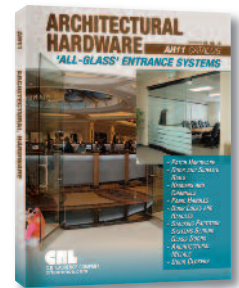

Glass and Glazing

- Mirror and Glass Hardware
- Door and Window Hardware
- Retail Display Hardware, and Standoffs
- Glazier's Tools and Machinery
- Sealants, Adhesives, and Fasteners
- UV Glass Bonding

Ask for Extension

7720

Direct Fax (866) 921-0531

Direct E-Mail glazing@crlaurence.com

CRL53

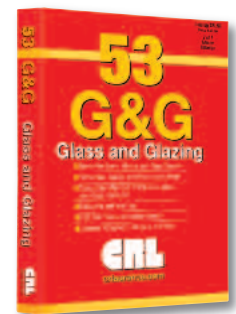

Architectural Railings

- Aluminum Railing Systems
- Cap Railing Systems
- Hand Railing Systems
- Post Railing Systems
- Windscreen and Gate Systems
- Heavy Glass Base Shoe

Ask for Extension

7730

Direct Fax (800) 587-7501

Direct E-Mail railings@crlaurence.com

HR11



Online Assistance by Telephone:

United States (800) 421-6144

Canada (877) 421-6144

International (323) 588-1281

Ask for Extension

6200

Technical Sales Business Groups

Frameless Shower Door

- Hinges and Clamps
- Knobs and Pull Handles
- Towel and Grab Bars
- Sliding Shower Enclosures
- Vanity and Wardrobe Mirrors

Ask for Extension

7740

Direct Fax (800) 458-7496
Direct E-Mail showers@crlaurence.com

SD10

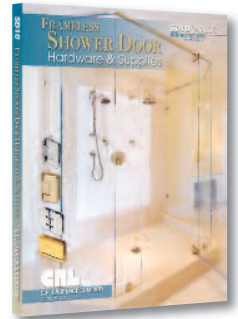

Hospitality and Service

- Partition Posts and Booth Dividers
- Food Service Sneeze Guards
- Tray Slide Hardware
- Menu Boards
- Bar Fixtures

Ask for Extension

7760

Direct Fax (800) 458-7496
Direct E-Mail hospitality@crlaurence.com

HS07



Transaction and Security

- Drive-Thru and Walk-Up Service Windows
- Bullet Resistant Exchange Windows
- Ticket and Cashier Windows
- Cash Tray and Deal Drawers
- Speak-Thru Devices
- Safety and Security Mirrors

Ask for Extension

7760

Direct Fax (800) 458-7496
Direct E-Mail transaction@crlaurence.com

TH10



Architectural and Ornamental Metals

- Clad Entrances and Storefronts
- Canopies and Sunshades
- Metal Wall Panels
- Column Covers (Cladding)
- Ornamental Hand and Guard Rails
- Break Shaped Metals

Ask for Extension

7770

Direct Fax (866) 921-0532
Direct E-Mail archmetals@crlaurence.com

AM09



Automotive

- Truck Sliding Rear Windows
- Pop-Up and Electric Sunroofs
- Van and RV Windows
- Auto Glass Shop Products
- Auto Glass Tools

Ask for Extension

7780

Direct Fax (800) 587-7501
Direct E-Mail automotive@crlaurence.com

CRL43



Online Assistance by E-Mail: askus@crlaurence.com



CRL Manufacturing

- Making Quality Products for Almost 40 Years
- User of Progressive ISO9001:2008 Manufacturing Processes
- Mechanical and Technical Expertise Available to Assist Your Manufacturing Processes

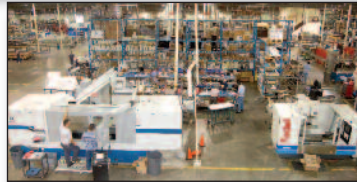

You may know C.R. Laurence Company as a global distributor of supplies to the glass industry however; you may not know that we are also a manufacturer of over 5,000 products found in our Online Catalog. Our 270,000 plus square foot manufacturing plant in Vernon, California is just five minutes from CRL Corporate Headquarters, and ten minutes from downtown Los Angeles. It is here that we make some of the best products available to customers worldwide. Our people use progressive ISO9001:2008 manufacturing processes to make products for the Glazing, Railing, Architectural, Construction, Industrial, and Automotive industries. These certified processes ensure that we give every product our full attention to detail.

There are many industries served by the products manufactured in our California plant. We make architectural hardware for new and retrofit building construction, railing systems and windscreens for balconies and decks, security transaction windows and devices, display hardware for the retail trade, specialty tools for the glazing trade, hinges and other products for frameless shower doors, and automotive windows for trucks, vans, and RV's.

Using strict manufacturing standards we produce the kind of quality hardware that has kept us at the head of this field for many years. That's your assurance that when you select a product made by CRL Manufacturing you have made the best possible choice.

We're always looking for ways to make our products better, and along the way we've added knowledgeable experts in their fields to our staff of designers, engineers, and craftspeople. Our goal is to make our products a better value to you, whether it's time or labor savings, extended service life, increased versatility or enhanced visual appeal.

Many of our products incorporate industry "firsts", features offered by no other manufacturer because we feel that no product or process is so good that it can't be improved. We strive to make products of high quality and value. That's the goal we set for ourselves at the onset, and it's still our guiding influence.

Some of the improvements we've made have originated from people who have used our products and generously contributed their opinions and suggestions. We welcome your comments, and invite you to contact us at any time regarding a C.R. Laurence product.



LP11 CATALOG A TO Z PRODUCT INDEX

4" x 10" Center Locks	L212-L213
6" x 10" Center Locks	L214-L215

A

A.D.A. Door Rail Adaptor	L231
Access Control Handles	L233-L235
All-Glass Door Access Control Handles	L218-L223
All-Glass Door Handles.....	L224-L228
All-Glass Storefronts Online	L240-L241
Aluminum Base Shoe	L238-L239
Aluminum Push Bars	L232

B

Back-to-Back Pull Handles	L224-L229
Base Shoe	L238-L239
Bolts, Sex	L232

C

Cam Plug	L231
Catalogs and Literature	L245
Center Lock Glass Keepers.....	L212-L213, L215-L216
Center Lock Strikes	L212, L216
Center Locks	L212-L215
Classroom Locks	L215
Combination Push-Pull Handles	L225, L230
Commercial Door Handles	L229-L231
Commercial Door Hardware.....	L232
Concealed Vertical Rod Panic Devices	L234-L235
Cores (SFIC)	L217
CRL Manufacturing	L248
CRL Online Catalog.....	L242-L243
Cross Bar Panic Exit Devices	L233
Custom Door Handles	L230

D

Deadbolt Handles	L220-221
Deadlatch Electric Strikes.....	L216
Directory, Phone/Fax/E-mail	L246-L247
Door	
Handles	L224-L232
Kick Plate	L232
Pulls	L224-L230
Rail Adaptor (A.D.A.)	L231
Double Locking Ladder Pulls.....	L205, L207
Dustproof Keeper	L209

E

Electronic Egress Control Handles	L222-L223
Electronic Strikes	L216
Entrance Locks.....	L214
Extruded Aluminum Push Bars	L232

F

Frameless Sliding Door Handles	L228
--------------------------------------	------

G

Glass Keepers	L212-L213, L215-L216
Glass Mounted Door Handles.....	L224-L228

H

Handles	
Access Control	L233-L235
Back-to-Back	L224-L229
Custom.....	L230
Deadbolt.....	L220-L221
Electronic Egress	L222-L223
Ladder Style	L200-L201
Lever Style	L231
Locking Ladder Style	L202-L208
Panic.....	L218-L219
Push-Pull	L225, L230
Heavy Aluminum Base Shoe	L238-L239
Horizontal Locking Ladder Pull and Keeper.....	L208

I

Interchangeable Cores	L217
-----------------------------	------

J

Jackson 10 Series Panic Exit Devices	L234
Jackson 10 Series Push-Pad Retrofit Device	L235
Jackson 1200 Series Panics	L235
Jackson 20 Series Panic Exit Devices	L234

K

Keepers, Center Lock	L212-L213, L215-L216
Keepers, Locking Ladder Pull	L209
Keyed Small Format Interchangeable Cores	L217
Kick Plate	L232

L

Ladder Keepers	L209
Ladder Pull Offset Mid-Posts	L200
Ladder Style Pull Handles	L200-L201, L227
Laminated Glass Base Shoe.....	L238
Leather Wrapped Locking Ladder Pulls.....	L203
Lever Handles	L231
Locking Ladder Pull Keepers	L209
Locking Ladder Pulls	L202-L208
Low Profile Base Shoe	L239

M

Manufacturing	L248
Mitered Corner Style Pull Handles	L224
Monolithic Tempered Base Shoe	L238-L239
Mortise Housing for (SFIC)	L217

N

Narrow Stile Push-Pad Rim Panic Exit Devices	L233
--	------

O

Office Locks	L214
Offset Mid-Posts	L200
Offset Pull Handles	L224-L225, L229-L230
One Point Center Locks	L210-L211
Online Catalog Information.....	L242-L243
Online Storefronts Design Program	L240-L241

P

Panic Exit Devices.....	L233-L235
Panic Handles	L218-L219
Passage Locks	L215
Phone, Fax, and E-mail Directory	L246-L247
Plumb/Angle/Level Locator Kit.....	L236
Pull Handles	L224-L230
Pull Plate.....	L232
Push Bars	L232
Push Button Center Locks and Keepers	L215
Push Plate.....	L232
Push-Pad Rim Panic Exit Devices	L233
Push-Pull Combination Handles	L225
Push-Pull Paddles	L231

R

Railing Base Shoe.....	L238-L239
Railing System Information	L236-L239
Rim Panic Device	L234-L235
Round Handle Pull Plate	L232
Rounded Corner Square Tube Pull Handle	L225

S

"S" Style Ladder Pulls	L201
Sex Bolts.....	L232
Single Hole Keeper	L209
Sliding Door Handles	L228
Small Format Interchangeable Cores (SFIC)	L217
Square Tube Style Pull Handles	L225
Storefronts Online® Design Program	L240-L241
Storeroom Locks	L215
Straight and Offset Back-to-Back Pull Handles	L224
Straight Style Ladder Pulls.....	L200
Strikes	L212, L215
Surface Vertical Rod Panic Devices	L235

T

Tapered Base Shoe.....	L239
Tapered Door Pull.....	L229
TAPER-LOC™ Glass Railing System	L236-L237
TAPER-LOC™ Installation/Removal Tool	L237
TAPER-LOC™ Taper Sets.....	L237
Thru-Glass Pull.....	L228
Triangular Locking Ladder Pulls.....	L206-L207
Two Point Center Locks	L211

U

Universal Push-Pull Paddles	L231
Upgrade Kit for TLK5	L237

V

Variant Series Pull Handles	L228
Vertical Rod Panic Devices	L234-L235

W

Windscreen Base Shoe	L239
----------------------------	------

IMAGE GALLERY:

CRL has an Image Gallery of projects fabricated using our products. We invite you to submit images of projects you have done using our Architectural Hardware products. E-mail your images to crl@crlaurence.com. Tell us a little about the project, and which CRL products you used to complete it. Be sure to include your name and return e-mail address so we can contact you. We thank you in advance for your contributions.



C.R. LAURENCE COMPANY

An ISO9001:2008 Certified Company

CAT. NO. **LP11**



UNITED STATES

Visit Our Web Site: crlaurence.com

Corporate Headquarters
LOS ANGELES, CALIFORNIA
Phone: (323) 588-1281
Fax: (323) 581-6522

ATLANTA, GEORGIA
Phone: (404) 696-3445
Fax: (404) 696-3386

BOSTON AREA, MASSACHUSETTS
Phone: (508) 880-5600
Fax: (508) 880-5775

CHICAGO AREA, ILLINOIS
Phone: (847) 426-3800
Fax: (847) 426-0111

CLEVELAND AREA, OHIO
Phone: (440) 248-0003
Fax: (440) 248-0120

DALLAS, TEXAS
Phone: (214) 634-7305
Fax: (214) 631-6519

Toll Free Phone: (800) 421-6144
DENVER, COLORADO
Phone: (303) 373-9988
Fax: (303) 373-0884

HOUSTON, TEXAS
Phone: (713) 462-6300
Fax: (713) 462-6306

LAS VEGAS, NEVADA
Phone: (702) 253-0211
Fax: (702) 253-0311

MIAMI AREA, FLORIDA
Phone: (954) 846-9233
Fax: (954) 846-9277

NEW YORK CITY AREA
Phone: (201) 770-1077
Fax: (201) 770-1599

ORLANDO, FLORIDA
Phone: (407) 857-7900
Fax: (407) 857-7766

Toll Free Fax: (800) 262-3299
PHILADELPHIA AREA
Phone: (856) 727-1022
Fax: (856) 727-3299

PHOENIX, ARIZONA
Phone: (602) 269-7500
Fax: (602) 269-7600

SAN FRANCISCO / OAKLAND AREA
Phone: (510) 475-1000
Fax: (510) 475-1404

SEATTLE AREA, WASHINGTON
Phone: (253) 850-5800
Fax: (253) 813-1818



**SOMMER AND MACA
GLASS MACHINERY DIVISION
CICERO, ILLINOIS**
Phone: (773) 242-2871
Fax: (708) 863-5462



CRL CANADA crlaurence.ca

Corporate Headquarters
TORONTO AREA, ONTARIO
Phone: (905) 303-7966
Fax: (905) 303-7965

MONTREAL AREA, QUEBEC
Phone: (514) 352-3300
Fax: (514) 352-1017

CALGARY, ALBERTA
Phone: (403) 250-5783
Fax: (403) 291-3260

VANCOUVER AREA, B.C.
Phone: (604) 448-9344
Fax: (604) 448-9322

Toll Free Phone: (800) 421-6144
Toll Free Fax: (800) 262-3299



CRL AUSTRALIA crlaurence.com.au

Toll Free Phone: 1800 424-275
Toll Free Fax: 1800 813-013

**SYDNEY AREA,
NEW SOUTH WALES**
Phone: (02) 9851-3444
Fax: (02) 9851-3445

**MELBOURNE AREA,
VICTORIA**
Phone: (03) 9764-8322
Fax: (03) 9764-8378



CRL EUROPE

Freephone: 00 800 0421 6144
Freefax: 00 800 0262 3299

**STUTTGART AREA,
GERMANY**
Phone: +49 (0)7062 915 93 15
Fax: +49 (0)7062 915 93 16
crlaurence.de

**MANCHESTER AREA,
ENGLAND**
Phone: +44 (0)1706 863 600
Fax: +44 (0)1706 869 860
crlaurence.co.uk



C.R. Laurence Corporate Headquarters in Los Angeles, California.

C.R. LAURENCE CO., INC.

Corporate Headquarters

Post Office Box 58923, Los Angeles, CA 90058-0923

International Phone: (323) 588-1281 • International Fax: (323) 581-6522

© Copyright 2009, C.R. Laurence Co., Inc.

C.R. LAURENCE MANUFACTURING

Los Angeles, California

Phone: (323) 588-1281 • Fax: (323) 581-6522

COMMERCIAL HARDWARE TECH SALES

Phone: (800) 421-6144 or (323) 588-1281 Ext. 7700

Direct Fax: (800) 587-7501 or (323) 584-5289

Direct E-Mail: architectural@crlaurence.com